

**KATALOG
INWESTYCYJNY**
Oferta
produktowa
**INVESTMENT
CATALOGUE**
Product offer

2014/2015



Dekoracje ceramiczne
Ceramic decorations



Mozaiki
Mosaic tiles



Gresy nieszkliwione
Unglazed porcelain tiles



Gresy szklione
Glazed porcelain tiles



Płytki ściennie i podłogowe
Wall and floor tiles

**KATALOG
INWESTYCYJNY
GRUPY
ROVESE
OFERTA
PRODUKTOWA
2014/2015**
ROVESE
GROUP
INVESTMENT
CATALOGUE
PRODUCT
OFFER
2014/2015

WPROWADZENIE
INTRODUCTION



Jesteśmy dynamicznie rozwijającą się grupą kapitałową, działającą na międzynarodowym rynku płytek ceramicznych i kompleksowego wyposażenia łazienek. W skład Grupy ROVESE wchodzi renomowane europejskie marki: Cersanit, Opoczno, Meissen i Pilkington's. W ramach naszego portfolio oferujemy szerokie spektrum wyrobów wykorzystywanych przy wykańczaniu obiektów publicznych oraz pomieszczeń w budynkach mieszkalnych: płytki ceramiczne, ceramikę sanitarną, wanny, kabiny prysznicowe i brodziki, meble oraz akcesoria łazienkowe.

Rynek inwestycyjny jest dla nas niezwykle ważny. Dlatego tworząc katalog, staraliśmy się sprostać oczekiwaniom naszych Partnerów i zaprezentować produkty zgodnie z ich potrzebami. Aby ułatwić wybór produktów o odpowiednich parametrach, ofertę płytek ceramicznych prezentujemy w podziale uwzględniającym rodzaj obiektów, do których rekomendujemy poszczególne kolekcje. Pozostały asortyment – ceramikę sanitarną, wanny i kabiny prysznicowe – ze względu na uniwersalność zastosowań, przedstawiamy grupami produktowymi.

W każdej z grup oferta ułożona została według kategorii PRESTIGE i STANDARD, co ułatwi wybór dla określonego typu inwestycji. PRESTIGE to produkty o najwyższych parametrach użytkowych oraz ponadprzeciętnym designie. Produkty STANDARD zachowują w pełni parametry odpowiednie do danego zastosowania, ale jednocześnie, dzięki niższej kategorii cenowej pozwalają na znaczne obniżenie kosztów inwestycji.

Szczególną uwagę chcielibyśmy zwrócić na sekcję z opisem naszych najnowszych, innowacyjnych technologii, zastosowanych w wybranych liniach oraz opis parametrów użytkowych wszystkich naszych produktów.

A fast-growing capital group with a strong international presence in the market of ceramic tiles and bathroom fixtures, Rovese includes some of Europe's best-known household names, Cersanit, Opoczno, Meissen and Pilkington's. We offer an extensive range of products for indoor and outdoor use in public-access spaces and residential interiors: ceramic tiles, sanitary ceramics, bathtubs, shower enclosures, shower trays as well as bathroom furniture and accessories.

We realize how important property development projects are for our core business, and have designed this catalogue to meet the specific needs and expectations of our partners from the sector. To facilitate easy searching for relevant product information, we have presented ceramic tiles in sections based on the recommended relevance of our collections for particular types of buildings and spaces. Universal products, on the other hand – sanitary ceramics, bathtubs, and shower enclosures – are grouped by product type.

Products from each product group are divided into two categories, PRESTIGE and STANDARD, which makes it easier to find products recommended for specific types of projects. PRESTIGE collections meet the highest standards of quality and feature unique designs while STANDARD products meet the parameters required for specific applications, at the same time allowing investors to significantly cut costs by using less expensive products.

We have placed special emphasis on the section describing our most recent technological innovations, put into practice in selected product lines, and on the technical specification of all products from our range.



PŁYTKI
CERAMICZNE
**CERAMIC
TILES**

1

CIĄGI KOMUNIKACYJNE
Komunikacja w obiektach
użyteczności publicznej i budynkach
mieszkalnych wielorodzinnych
HIGH-TRAFFIC AREAS
High-traffic thoroughways
in public-access spaces
and multi-family residential buildings

PRESTIGE 30

STANDARD 56

2

ŁAZIENKI PUBLICZNE,
Łazienki ogólnodostępne
oraz pomieszczenia socjalne
w obiektach użyteczności publicznej
RESTROOMS
Public bathrooms and social rooms
in public-access buildings

PRESTIGE 66

STANDARD 88

3

ŁAZIENKI HOTELOWE
Łazienki hotelowe
oraz łazienki i kuchnie
w budynkach mieszkalnych
HOTEL BATHROOMS
Hotel bathrooms as well
as bathrooms and kitchens
in residential settings

PRESTIGE 96

STANDARD 112

4

ELEWACJE, TARASY
BUILDING FAÇADES
AND TERRACES

PRESTIGE 126

STANDARD 134



CERAMIKA
SANITARNA
**SANITARY
CERAMICS**

1

UMYWALKI
WASHBASINS
PRESTIGE 162
STANDARD 172

2

MISKI ZAWIESZANE
WALL HUNG BOWLS
PRESTIGE 186
STANDARD 192

3

WC KOMPAKTY
WC COMPACTS
PRESTIGE 202
STANDARD 208

4

BIDETY
BIDETS
PRESTIGE 216
STANDARD 220



PISUARY
URINALS
222

STELAŻE PODTYNKOWE
**CONCEALED
CISTERN FRAMES**
224

WYPOSAŻENIE DLA
NIEPEŁNOSPRAWNYCH
**BATHROOM FIXTURES
FOR THE DISABLED**
230

WANNY
KABINY
BRODZIKI
**BATHTUBS
SHOWER ENCLOSURES
AND SHOWER TRAYS**

1

WANNY
BATHTUBS
244

2

KABINY
BRODZIKI
**SHOWER ENCLOSURES
AND SHOWER TRAYS**
268

INDEKS
ALFABETYCZNY
ALPHABETICAL
INDEX



PŁYTKI
CERAMICZNE
**CERAMIC
TILES**

- | | | | |
|---|--|---|--|
| <p>A</p> <p>A100 / 61
Alba / 91
Allwood / 104
Amarante / 83
Ancona / 88
Arancia / 115
Arkos / 66, 126
Artiga / 118
Artwood / 131
Arvena / 116
Atola / 116
Avangarde / 81</p> | <p>E</p> <p>Elegant Stripes / 103
Early Pastels / 80
Equinox / 49
Etna / 60</p> | <p>M</p> <p>Metalic / 82
Milton / 56, 135
Misto / 121
Misty Stone / 132
Mount Everest / 60
Monte Rosa / 60
Mont Blanc / 60
Moondust / 30
Modena / 112
Mojave / 134</p> | <p>S</p> <p>Sahara / 71
Salonika / 109
Scandic Life / 133
Selene / 117
Shadow / 140
Silent Stone / 133
Simple / 138
Solar / 136
Spazio / 72
Steel / 112
Stone Flowers / 100
Synthia / 113
Syrio / 89</p> |
| <p>B</p> <p>Baricello / 111
Basic Palette / 96
Bianca / 90
Black&White / 106
Bristo / 120
Brosto / 120</p> | <p>G</p> <p>Geometric Game / 102
Gusto / 121</p> | <p>N</p> <p>N500 / 61
Naturale / 105
Nodo / 131
Nutto / 121</p> | <p>T</p> <p>Tosto / 95
Trawertino / 119</p> |
| <p>C</p> <p>Creamy Touch / 78
Calsto / 120
Capri / 107
Carrara / 76</p> | <p>H</p> <p>HX200 / 60
H200 / 61
Hyperion / 58</p> | <p>O</p> <p>Orisa / 84</p> | <p>U</p> <p>Urban Mix / 34</p> |
| <p>D</p> <p>Daino / 51, 67, 127
Damasco / 75
Deckwood / 131
Diantus / 115
Dry River / 40
Dusk / 45</p> | <p>I</p> <p>Ikaria / 91
Inwencja / 86</p> | <p>P</p> <p>Palette / 85
Penne / 84
Playa / 71, 128
Pret-a-Porter / 101</p> | <p>V</p> <p>Visione / 79
Vivid Colours / 99</p> |
| <p>L</p> <p>Lavande / 116
Lazarro / 74
Lazio / 73
Legno Moderno / 130
Legno Rustico / 130
Livingwood / 104
Lotos / 60
Light Marble / 79</p> | <p>K</p> <p>KX300 / 60
K300 / 61
Kallisto / 54, 56
Kando / 52
Karoo / 81</p> | <p>Q</p> <p>Quartz / 126</p> | <p>W</p> <p>White Magic / 98</p> |
| | | <p>R</p> <p>RX400 / 60
R400 / 61</p> | <p>Y</p> <p>Yakara / 68, 128, 51</p> |
| | | | <p>Z</p> <p>Zebrano / 110</p> |

INDEKS
ALFABETYCZNY
ALPHABETICAL
INDEX



CERAMIKA
 SANITARNA
SANITARY
CERAMICS

- | | | | |
|---|---|---|--|
| A | Arteca / 207
Arteco / 172,193,207
Amao / 171
Apollo / 223 | M | Malmo / 164, 189, 217
Merida / 211 |
| B | Bilbao / 165, 188, 216
Calla / 171
Carina / 168, 186, 202, 219
Carla / 180
Caspia / 169
Cersania / 180
Colour / 163, 191, 205
Como / 163 | O | Olimpia / 167, 191, 205, 219
Omega / 181
Ontario / 170
Parva / 179, 192, 194, 206, 208
Pisuar P 101 / 222
President / 176, 197, 211
Pure / 166, 190, 204, 218 |
| D | Delfi / 195, 220
Easy / 162, 187, 203
Eko / 179 | P | Roma / 181 |
| E | Etiuda / 230 | R | Sigma / 178 |
| F | Facile / 173, 197, 209 | S | Slim&Silent / 226 |
| G | Gamma / 171 | T | Taurus / 223
Teta / 178 |
| H | Hi-Tec / 227 | Z | Zenit / 210
Zuro / 171 |
| I | Iryda / 175, 195, 208, 221 | | |
| K | Kioto / 165, 189, 217 | | |
| L | Libra / 181
Link / 229 | | |



WANNY,
KABINY, BRODZIKI
**BATHTUBS,
SHOWER ENCLOSURES,
AND SHOWER TRAYS**

- A | Ariza / **260**
- B | Bilbao / **249**
- E | Easy / **262**
- F | Flavia / **254**
- I | Ineba / **271**
- I | Intro / **251**
- J | Joanna / **261**
- K | Kaliope / **258**
- K | Korat / **245**
- M | Malmo / **248**
- M | Meza / **246**
- N | Nama / **268**
- N | Nano / **259**
- N | Nike / **255**
- O | Octavia / **256**
- O | Onega / **269**
- P | Pure / **250**
- S | Santana / **257**
- S | Saona / **270**
- S | Sicilia / **252**
- T | Tako / **272**
- V | Venus / **253**
- V | Virgo / **247**
- Z | Zen / **244**

PŁYTKI
CERAMICZNE
CERAMIC
TILES





SMART SILVER TECHNOLOGY

Technologia Smart Silver® zastosowana w wybranych kolekcjach gresu szklwionego wprowadza zupełnie nowy standard jakościowy na rynku płytek ceramicznych. Na bazie wyników wieloletnich badań naukowych i opatentowanej technologii wdrożyliśmy innowacyjne rozwiązanie w dziedzinie ochrony przeciwbakteryjnej - skuteczniejsze i bardziej ekonomiczne od tradycyjnych metod, bazujących jedynie na środkach chemicznych.

W linii Smart Silver® podczas procesu szklwienia gresu wykorzystujemy dodatkowo jony srebra. Badania potwierdzają, że znajdujące się w szklwicie cząsteczki srebra mają silne działanie bakteriobójcze, zabijają także szkodliwe dla zdrowia grzyby i pleśń. Warstwa ta jest odporna na ścieranie, nie zanika ani nie zużywa się i zachowuje swoje właściwości przez cały okres użytkowania płytek. Wytworzona powłoka eliminuje nawet do 99,8% bakterii i grzybów.

Applied in selected collections of glazed porcelain tiles, Smart Silver® redefines quality standards on the market of ceramic tiles. Based on many years of research and a patented technology, this innovative solution in the field of anti-bacterial protection is more effective and cost-efficient than traditional methods, which rely exclusively on chemical substances.

Porcelain tiles from the Smart Silver® line are characterized by the use of silver cations in the glaze finish covering the surface of the tiles. Studies confirm that silver particles present in the glaze display strong anti-bacterial properties and eliminate harmful fungi and mold. Highly resistant to abrasion, wear, and fading, such surfaces retain their properties throughout their useful life, in addition to eliminating up to 99.8% of bacteria and fungi.

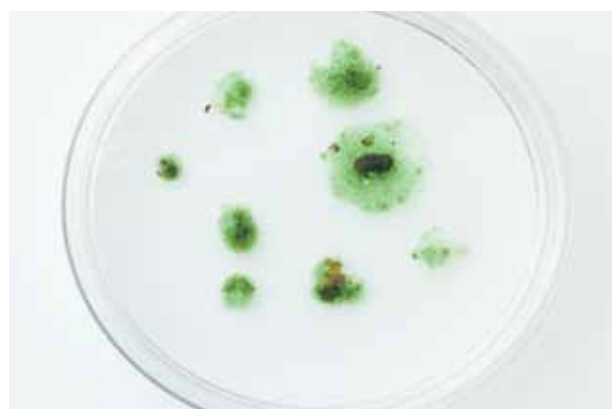

Powierzchnia płytki szklanej bez zastosowania technologii **SMART SILVER®**, czyszczona środkami bakteriobójczymi.
The surface of a glazed tile without **SMART SILVER®** technology, cleaned with anti-bacterial substances.

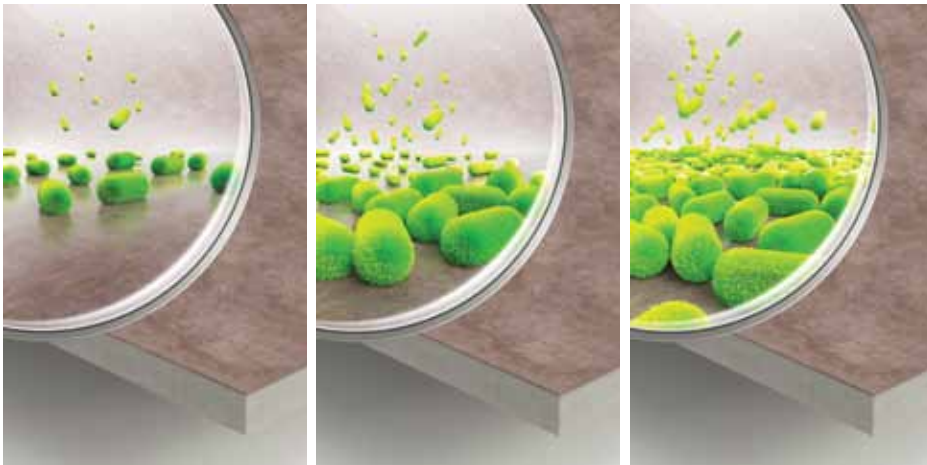

1 DZIEŃ / 1 DAY
po zastosowaniu
środka
bakteriobójczego
after the application
of a bacterial
disinfectant

1 TYDZIEŃ / 1 WEEK
po zastosowaniu
środka
bakteriobójczego
after the application
of a bacterial
disinfectant

2 TYGODNIE / 2 WEEKS
po zastosowaniu
środka
bakteriobójczego
after the application
of a bacterial
disinfectant

Powierzchnia płytki pokryta szklivem wyprodukowanym w technologii **SMART SILVER®**, bez użycia środków bakteriobójczych.
A glaze-covered surface incorporating the **SMART SILVER®** technology without bacterial disinfectants.

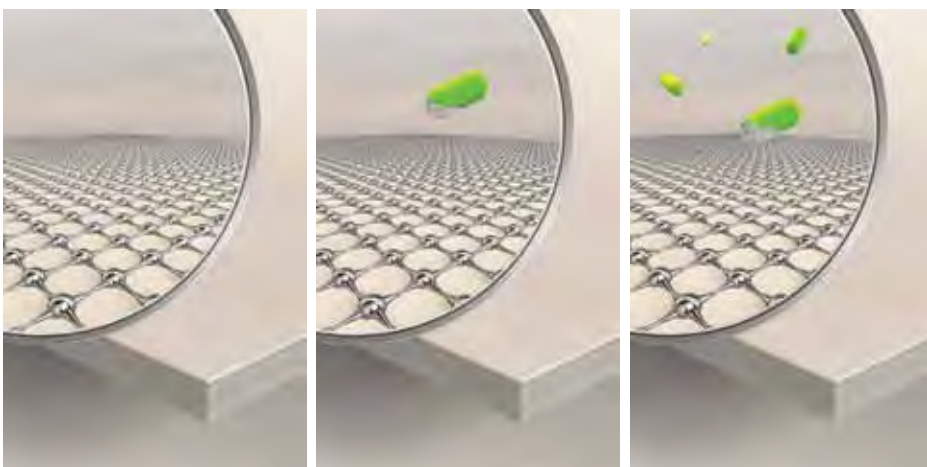

1 DZIEŃ / 1 DAY
po położeniu
płytek
after tile
installation

1 TYDZIEŃ / 1 WEEK
po położeniu
płytek
after tile
installation

2 TYGODNIE / 2 WEEKS
po położeniu
płytek
after tile
installation

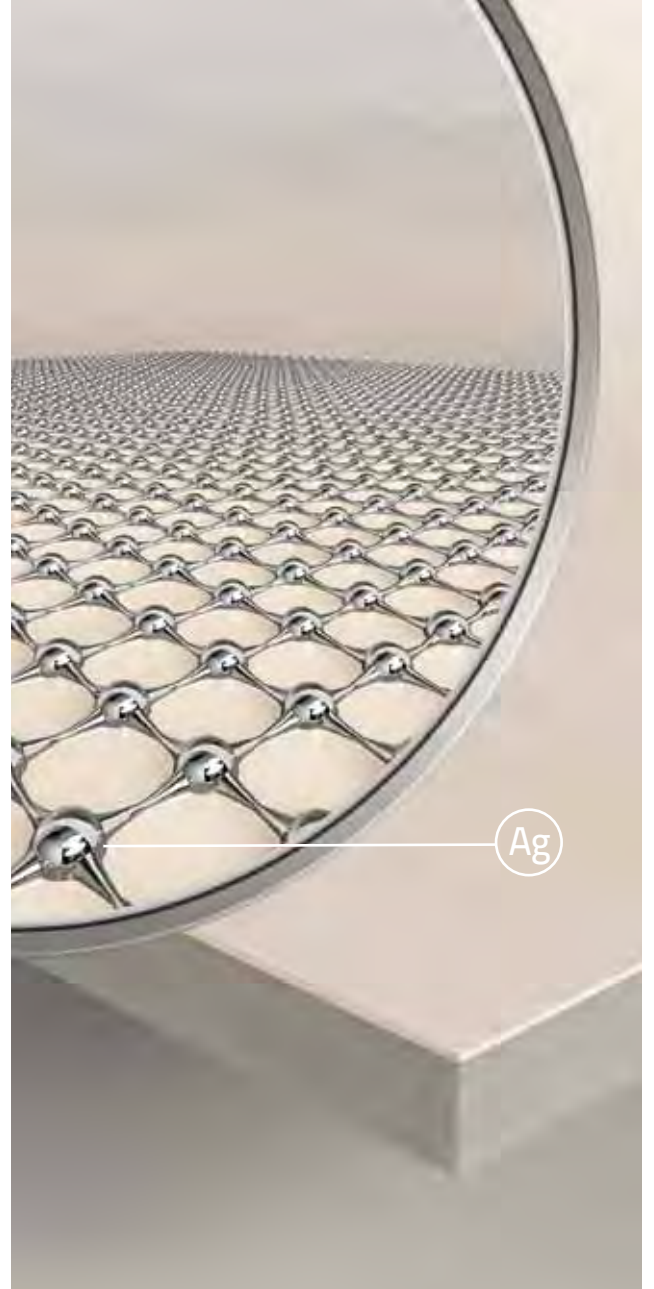

Technologia Smart Silver® niesie ze sobą przełom w ochronie antybakteryjnej, co w praktyce przekłada się na łatwiejsze utrzymanie czystości i tym samym - zwiększenie bezpieczeństwa użytkujących obiektów. Dzięki temu produkty Smart Silver® znajdują zastosowanie w pomieszczeniach publicznych o wysokich wymaganiach w zakresie higieny: szpitalach, przychodniach, centrach medycznych i sanatoriach, na basenach, w klubach fitness, hotelach, ośrodkach SPA czy choćby w szkołach.

Zastosowanie produktów z linii Smart Silver® zapewnia również dodatkową korzyść w postaci obniżenia kosztów utrzymania obiektu.

In practical applications, Smart Silver® products, based on a groundbreaking anti-bacterial technology, are easier to clean and safer to use. This is why they are used in public-access spaces where stringent hygiene standards are a must: hospitals, clinics, health centers, sanatoriums, swimming pools, fitness clubs, hotels, spas, and schools. As an additional benefit, products from the Smart Silver® help reduce maintenance costs.

PŁYTKI
CERAMICZNE
CECHY
PRODUKTÓW
CERAMIC
TILES
PRODUCT
FEATURES



grupa 1

[GRESY NIESZKLIWIONE]

[UNGLAZED PORCELAIN TILES]

Gres nieszkliwiony charakteryzuje się jednorodną, zwartą strukturą w całej swojej grubości. Dzięki temu, nawet intensywne wieloletnie użytkowanie nie powoduje zmiany barwy i struktury płytek. Twardość gresu nieszkliwionego jest zbliżona do twardości granitu, co zapewnia mu dużą odporność na ścieranie a dzięki niskiej nasiąkliwości wodnej, jest mrozoodporny. Zastosowane materiały oraz technologia produkcji powodują, że gres nieszkliwiony może być stosowany na powierzchniach o najwyższym natężeniu ruchu. Unglazed porcelain tiles are characterized by a dense uniform structure throughout the body of the tile. Even when subjected to intensive use for many years, such tiles do not change their color or structure and their hardness is similar to that of granite, which makes them highly resistant to abrasion. Low water absorption, in turn, translates into frost resistance. The materials and technologies applied in the production of unglazed porcelain tiles make them suitable for surfaces with even the heaviest traffic.



grupa2

[GRESY SZKLIWIONE]

[GLAZED PORCELAIN TILES]

Gres szkliony zachowując większość zalet gresu nieszkliwionego, ma przy tym niemal nieograniczone możliwości wzornicze. Dzięki cienkiej, ozdobnej warstwie szkliwa może mieć dowolny kolor, wzór a nawet strukturę. Szklivo zabezpiecza również przed trwałym zabrudzeniem podczas użytkowania. Gres szkliony o najwyższej klasie ścieralności może być stosowany nawet w miejscach, gdzie natężenie ruchu jest bardzo wysokie. Jest idealny do zastosowania w miejscu, gdzie wysokie walory estetyczne płytek powinny łączyć się z najwyższymi parametrami technicznymi.

In addition to retaining most of the advantages of unglazed surfaces, glazed porcelain tiles provide virtually endless design possibilities. A thin layer of decorative glaze may come in any color, pattern, and texture. Glazing also protects tiles from permanent staining. Glazed porcelain tiles with the highest wear resistance ratings may be used even in areas with very intensive traffic. They are perfectly suited to spaces requiring finishes that combine esthetic design and top-notch technical ratings.

grupa3

[PŁYTKI ŚCIENNE]

[WALL TILES]

Powierzchnia płytek ściennych pokryta jest cienką warstwą szkliwa, co zabezpiecza je przed zaplamieniem, ułatwia utrzymanie w czystości oraz zapewnia maksymalną higienę podczas użytkowania. Gwarantuje też zachowanie pierwotnego koloru w całym okresie eksploatacji. Dzięki nieograniczonym możliwościom technologicznym zdobienia można uzyskać płytki praktycznie w każdym kolorze i o dowolnym wzornictwie; oraz o różnym wykończeniu powierzchni: błyszczące, matowe, strukturalne.

Wall tiles are covered with a thin layer of glaze to ensure stain resistance, easy cleaning, and maximum hygiene. Such tiles will retain their original color throughout their useful life. Offering unlimited decoration possibilities, wall tiles are available in practically all colors, motifs, and surface finishes: glossy, matte, and textured.



PŁYTKI
CERAMICZNE
CECHY
PRODUKTÓW
CERAMIC
TILES
PRODUCT
FEATURES

WYJĄTKOWA
ESTETYKA
UNIQUE
ESTHETICS

MODULARNOŚĆ

MODULAR FIT

Uzupełniające się formaty płytek z tej samej kolekcji można łączyć ze sobą z zastosowaniem stałej szerokości fug. Dzięki różnorodności wymiarów płytek, zwiększają się możliwości tworzenia unikalnych kompozycji.

Multi-format tiles from the same collection may be combined, using the same grout joint width. Various size options open up greater possibilities for creating unique compositions.

g1

g2



DRUK CYFROWY

DIGITAL PRINTING

Nowoczesna technologia druku cyfrowego umożliwia precyzyjne odwzorowanie na powierzchni płytek grafiki naturalnych materiałów, takich jak np. drewno czy kamień. Daje także możliwość wykonania dużej liczby płytek z niepowtarzającym się wzorem w ramach tej samej kolekcji, co znacznie podnosi estetykę pomieszczenia.

Modern digital print technologies can faithfully reproduce the graphics of natural materials such as wood and stone on the surface of tiles. They also make it possible to manufacture large amounts of tiles with unique motifs within the same collection, for beautifully designed rooms.

g2

g3

BARWIONA BAZA

COLORED BODY

Zastosowanie podczas procesu produkcyjnego barwionej bazy, która może być dopasowana do tonacji szkliwa, znacznie zwiększa estetykę płytek rektyfikowanych. Ich precyzyjnie sfazowane krawędzie mają identyczny kolor jak powierzchnia całej płytki.

Pigments added to the tile mixture ensure that the glaze color will match the color of the tile body, significantly improving the esthetics of rectified tiles. Precision-chamfered edges show coloring identical to the surface of the whole tile.

g1

g2



REKTYFIKACJA

PERFECT EDGE SYSTEM

Rektyfikacja to proces przycinania i szlifowania krawędzi płytek, sterowany komputerowo. Dzięki temu otrzymujemy płytki o idealnych wymiarach. Pozwala to na zastosowanie fug o minimalnej szerokości, a co za tym idzie, jeszcze lepsze wyeksponowanie naturalnego piękna wzoru i faktury płytek oraz uzyskanie efektu jednolitej powierzchni.

Through a computer-controlled process of cutting and edge-grinding to produce tiles that are exactly the same size. Rectified tiles can be therefore installed with minimum grout joints to better highlight the natural beauty and texture of the tiles and achieve a seamless look.

g1

g2

g3



POLEROWANIE

POLISHED SURFACE

Proces mechanicznego polerowania płytek powoduje, że ich powierzchnia jest idealnie gładka oraz błyszcząca, sprawiająca wrażenie lustrzanej. Ciekawa estetyka tych płytek prezentuje się wyjątkowo efektownie zarówno na ścianach, jak i na podłogach. Płytki polerowane to również świetne uzupełnienie powierzchni, na której zastosowano płytki matowe. Smooth and shiny, mechanically polished tiles are characterized by a mirror-like surface. Interesting design options add an exceptional elegance to both walls and floors. Polished tiles are also a great complement to settings incorporating tiles in matte finishes.

g1

g2

**PŁYTKI
CERAMICZNE
CECHY
PRODUKTÓW
CERAMIC
TILES
PRODUCT
FEATURES**

**RÓŻNORODNE
ZASTOSOWANIE
VARIETY
OF APPLICATIONS**

ANTYPOŚLIZGOWOŚĆ

SLIP RESISTANCE

Strukturalna lub pokryta granulatem powierzchnia płytek oprócz walorów estetycznych zapewnia doskonałą ochronę antypoślizgową. Przekłada się ona na bezpieczeństwo i pewność użytkowania płytek w różnych warunkach. Możemy stosować je również bez obaw w miejscach o zwiększonym natężeniu ruchu. Skuteczność antypoślizgowa płytek ROVESE została potwierdzona normą DIN 51130.

In addition to esthetic values, textured or granulated tile surfaces provide excellent slip resistance, which makes such tiles reliable and safe in different conditions. Slip resistant tiles can be installed in high-traffic areas. The slip resistance of ROVESE tiles is compliant with DIN 51130 standards.

g2



OGRZEWANIE PODŁOGOWE

FLOOR HEATING READY

Płytki gresowe dzięki bardzo niskiemu współczynnikowi cieplnej rozszerzalności liniowej doskonale sprawdzają się w pomieszczeniach z ogrzewaniem podłogowym. Współczynnik ten dla gresu szkliwionego i nieszkliwionego Rovese jest zgodny z wymaganiami normy PN-EN ISO 10545-8.

Porcelain tiles have very low linear thermal expansion coefficients, so they are perfectly suited for interiors with floor heating. Linear thermal expansion coefficients for Rovese's glazed and unglazed porcelain tiles are consistent with the requirements of the PN-EN ISO 10545-8 standard.

g1 g2





WEWNĄTRZ I NA ZEWNĄTRZ

INDOOR & OUTDOOR

Bardzo niska nasiąkliwość wodna oraz związana z tym parametrem mrozoodporność i wysoka wytrzymałość mechaniczna powoduje, że gres jest najbardziej uniwersalnym materiałem wykończeniowym. Płytki gresowe nadają się zarówno do wnętrza jak i na zewnątrz. Równie dobrze sprawdzą się na tarasie i elewacji, jak też w łazience, kuchni czy salonie.

Low water absorption rates and the related high resistance to frost and mechanical wear make porcelain tiles the most universal finishing material for both interior and exterior settings. They are equally well-suited to terraces and building façades as well as bathrooms, kitchens, and living rooms.

g1

g2

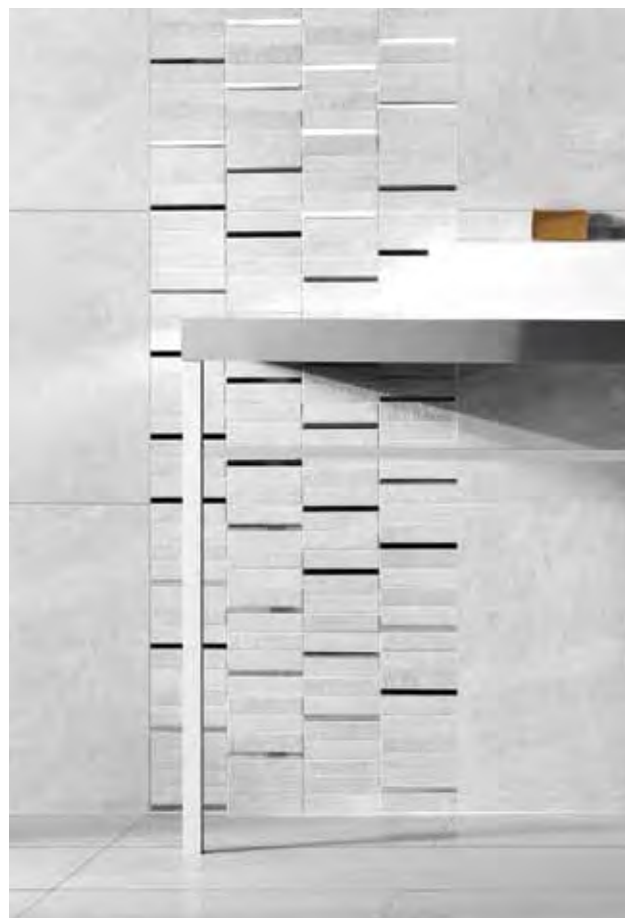

ŚCIANY I PODŁOGI

WALLS & FLOORS

Uniwersalne wzornictwo, nowe techniki zdobienia oraz doskonałe parametry techniczne umożliwiają stosowanie płytek gresowych zarówno na ścianach, jak i na podłogach. Gres staje się materiałem uniwersalnym, który można stosować praktycznie na każdej powierzchni i we wszystkich rodzajach pomieszczeń.

Universal design combined with new decoration techniques and top technical ratings make porcelain tiles suitable for both walls and floors. Porcelain tiles are universal materials that can be installed practically on any surface and in any setting.

g1

g2

**PŁYTKI
CERAMICZNE
CECHY
PRODUKTÓW
CERAMIC
TILES
PRODUCT
FEATURES**

PODWYŻSZONA
TRWAŁOŚĆ
**GREATER
DURABILITY**



**WYTRZYMAŁOŚĆ
EXTRA STRONG**

Płytki gresowe dzięki wyjątkowo niskiej porowatości oraz procesowi formowania ich pod bardzo dużym ciśnieniem cechują się doskonałymi parametrami wytrzymałościowymi. Podwyższona odporność mechaniczna daje możliwość stosowania ich w pomieszczeniach, w których występują ponadprzeciętne obciążenia oraz zwiększone natężenie ruchu. Wytrzymałość na zginanie oraz siła łamiąca spełniają wymagania normy PN-EN ISO 10545-4.

Formed under very high pressure, porcelain tiles are characterized by exceptionally low porosity and excellent resistance. Greater mechanical resistance means that porcelain tiles tolerate high loads and can be used in areas characterized by intensive traffic, in addition to meeting the bending and breaking strength requirements defined in the standard PN-EN ISO 10545-4.

g1

g2

**MROZODPORNOŚĆ
FROST RESISTANCE**

Wszystkie gresy naszej produkcji cechują się minimalną wchłaniałością wody i niską porowatością, dzięki czemu są odporne nawet na skrajnie niskie temperatury. Można je stosować praktycznie w każdych warunkach pogodowych. Mrozoodporność gresu Rovese potwierdzona jest badaniem wg normy PN-EN ISO 10545-12.

All porcelain tiles produced by Rovese are characterized by minimal water absorption rates and low porosity, which makes them resistant even to extremely low temperatures. Such tiles can be used in practically any weather conditions. The frost resistance of Rovese's porcelain tiles has been confirmed by tests consistent with the PN-EN ISO 10545-12 standard.

g1

g2



6 YEAR WARRANTY

GWARANCJA WARRANTY

Wszystkie Płytki Rovese objęte są 6-letnią gwarancją. Gwarantujemy zachowanie parametrów technologicznych i użytkowych określonych w normie PN-EN 14411.

All Rovese tiles come with a 6-year warranty and are guaranteed to retain their technical properties, as defined in the standard PN-EN 14411.

g1

g2

g3



ZDOBIONE W MASIE FULL BODY DECORATION

Zastosowanie w płytkach nieszkliwionych jednorodnej, barwionej masy w całym przekroju płytki powoduje, że otrzymujemy bardzo twarde i odporny na zarysowania produkt. Wytrzymuje on ponadprzeciętne obciążenia występujące podczas użytkowania. Płytki wykonane w tej technologii mogą być stosowane w miejscach o bardzo dużym natężeniu ruchu, szczególnie w obiektach użyteczności publicznej, jak również w obiektach przemysłowych: halach produkcyjnych, magazynach, itp.

Using a uniform, colored mixture for unglazed tiles yields a very hard and scratch-resistant product, able to withstand extreme loads. Tiles manufactured using this technology can be used in areas with very high traffic, especially public-access spaces, as well as at industrial facilities: factory floors, warehouses, etc.

g1

NIE WYMAGA IMPREGNACJI NO IMPREGNATION REQUIRED

Matowy gres nieszkliwiony naszej produkcji jest odporny na zabrudzenia, nie wymaga impregnacji. Rovese's matte unglazed porcelain tiles are resistant to staining and require no impregnation.

g1



Artwork title and artist information.

Artwork title and artist information.

Artwork title and artist information.

PŁYTKI
CERAMICZNE
CIĄGI
KOMUNIKACYJNE
CERAMIC
TILES
HIGH-TRAFFIC
AREAS

N^o1

**Komunikacja
w obiektach
użyteczności
publicznej
i budynkach
mieszkalnych
wielorodzinnych**
High-traffic
throughways
in public-access
spaces
and multi-family
residential
buildings





PŁYTKI
CERAMICZNE
CIĄGI
KOMUNIKACYJNE
CERAMIC
TILES
HIGH-TRAFFIC
AREAS





Płytki: Kando anthracite polished
Ceramic tiles: Kando anthracite polished



Ciagi Komunikacyjne
High-traffic Areas

PŁYTKI
CERAMICZNE
CIĄGI
KOMUNIKACYJNE
CERAMIC
TILES
HIGH-TRAFFIC
AREAS





Płytki: Yakara white
Ceramic tiles: Yakara white

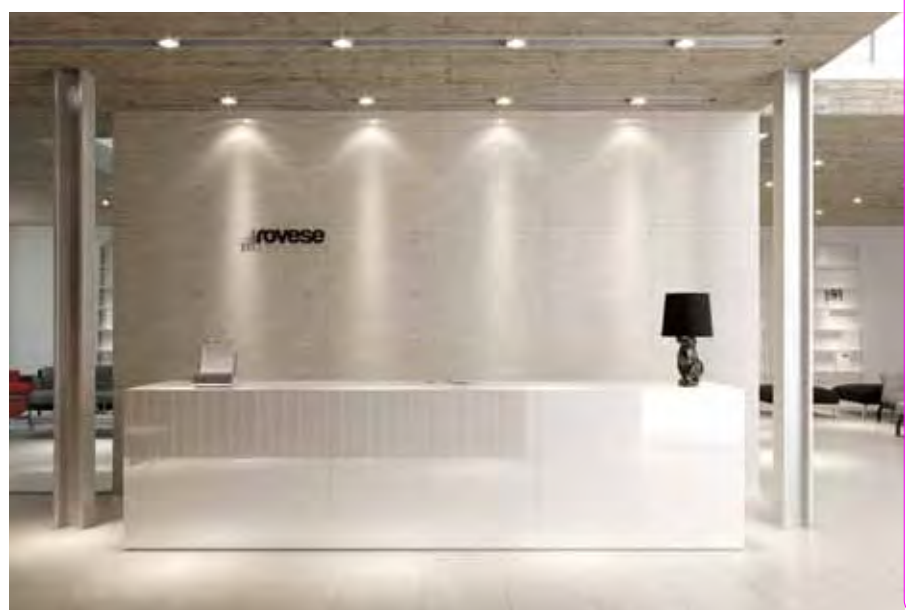

Ciagi Komunikacyjne
High-traffic Areas

**PŁYTKI
CERAMICZNE
CIĄGI
KOMUNIKACYJNE
CERAMIC
TILES
HIGH-TRAFFIC
AREAS**

MOONDUST >

GRES
NIESZKLIWIONY
**UNGLAZED
PORCELAIN
TILES**

NOWOŚĆ/NEW



MOONDUST cream 59,4 x 59,4
OP646-013-1
MOONDUST cream polished 59,4 x 59,4
OP646-025-1

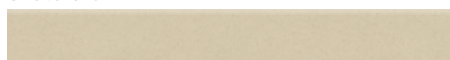

MOONDUST cream skirting 7,2 x 59,4
OD646-043
MOONDUST cream skirting polished 7,2 x 59,4
OD646-049



MOONDUST beige 59,4 x 59,4
OP646-014-1
MOONDUST beige polished 59,4 x 59,4
OP646-026-1



MOONDUST beige skirting 7,2 x 59,4
OD646-044
MOONDUST beige skirting polished 7,2 x 59,4
OD646-050



MOONDUST cream 29,55 x 59,4
OP646-019-1
MOONDUST cream polished 29,55 x 59,4
OP646-031-1



MOONDUST cream steptread
29,55 x 59,4
OP646-037-1

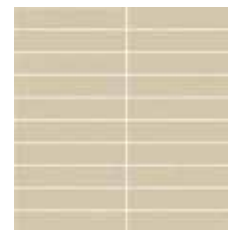

MOONDUST cream mosaic
29,5 x 29,5
OD646-055

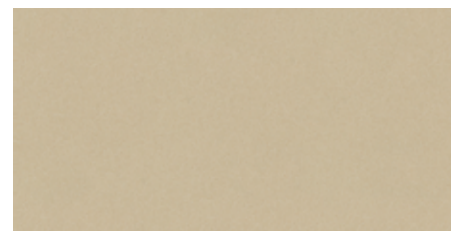

MOONDUST beige 29,55 x 59,4
OP646-020-1
MOONDUST beige polished 29,55 x 59,4
OP646-032-1



MOONDUST beige steptread
29,55 x 59,4
OP646-038-1

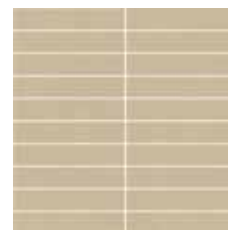

MOONDUST beige mosaic
29,5 x 29,5
OD646-056

* R10 - dotyczy tylko płytek matowych/ only matt tiles

MOONDUST >

GRES
NIESZKLIWIONY
UNGLAZED
PORCELAIN
TILES

Nowość/NEW



MOONDUST light grey 59,4 x 59,4
OP646-016-1
MOONDUST light grey polished 59,4 x 59,4
OP646-028-1



MOONDUST light grey 7,2 x 59,4
OD646-046
MOONDUST light grey polished 7,2 x 59,4
OD646-052



MOONDUST dark grey 59,4 x 59,4
OP646-017-1
MOONDUST dark grey polished 59,4 x 59,4
OP646-029-1



MOONDUST dark grey skirting 7,2 x 59,4
OD646-047
MOONDUST dark grey skirting polished 7,2 x 59,4
OD646-053

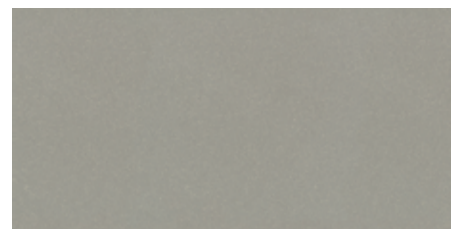

MOONDUST light grey 29,55 x 59,4
OP646-022-1
MOONDUST light grey polished 29,55 x 59,4
OP646-034-1



MOONDUST light grey steptread
29,55 x 59,4
OP646-040-1

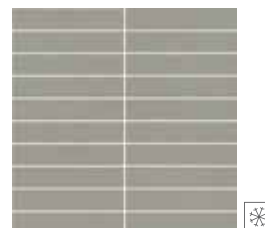

MOONDUST light grey mosaic
29,5 x 29,5
OD646-058

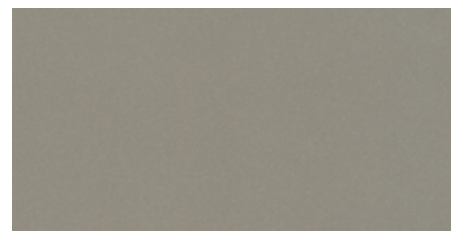

MOONDUST dark grey 29,55 x 59,4
OP646-023-1
MOONDUST dark grey polished 29,55 x 59,4
OP646-035-1



MOONDUST dark grey steptread
29,55 x 59,4
OP646-041-1

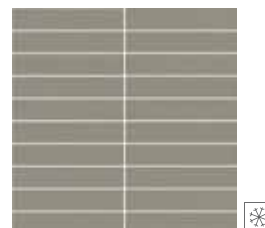

MOONDUST dark grey mosaic
29,5 x 29,5
OD646-059

* R10 - dotyczy tylko płytek matowych/ only matt tiles

**PŁYTKI
CERAMICZNE
CIĄGI
KOMUNIKACYJNE
CERAMIC
TILES
HIGH-TRAFFIC
AREAS**

MOONDUST >

GRES
NIESZKLIWIONY
**UNGLAZED
PORCELAIN
TILES**

NOWOŚĆ / NEW



MOONDUST mocca 59,4 x 59,4
OP646-015-1
MOONDUST mocca polished 59,4 x 59,4
OP646-027-1



MOONDUST mocca skirting 7,2 x 59,4
OD646-051
MOONDUST mocca skirting polished 7,2 x 59,4
OD646-045



MOONDUST black 59,4 x 59,4
OP646-018-1
MOONDUST black polished 59,4 x 59,4
OP646-030-1



MOONDUST black skirting 7,2 x 59,4
OD646-048
MOONDUST black skirting polished 7,2 x 59,4
OD646-054



MOONDUST mocca 29,55 x 59,4
OP646-021-1
MOONDUST mocca polished 29,55 x 59,4
OP646-033-1



MOONDUST mocca steptread
29,55 x 59,4
OP646-039-1

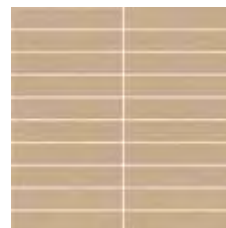

MOONDUST mocca mosaic
29,5 x 29,5
OD646-057

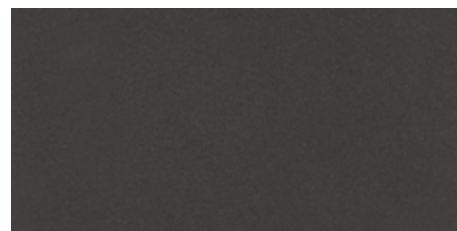

MOONDUST black 29,55 x 59,4
OP646-024-1
MOONDUST mocca polished 29,55 x 59,4
OP646-036-1



MOONDUST black steptread
29,55 x 59,4
OP646-042-1

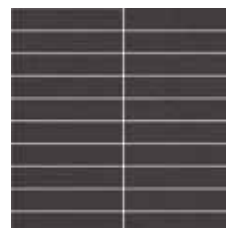

MOONDUST black mosaic
29,5 x 29,5
OD646-060

MOONDUST >

GRES
NIESZKLIWIONY
UNGLAZED
PORCELAIN
TILES

NOWOŚĆ / NEW

FORMATY NA SPECJALNE ZAMÓWIENIE SPECIAL ORDER SIZES

O szczegóły zapytaj naszego przedstawiciela handlowego
Ask our sales representative for details

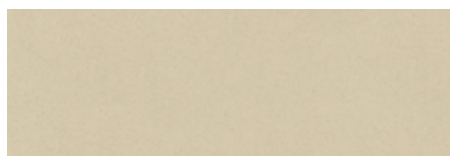

MOONDUST cream
19 x 59,4
MOONDUST cream polished
19 x 59,4



R10



MOONDUST cream
29,55 x 29,55
MOONDUST cream polished
29,55 x 29,55



R10

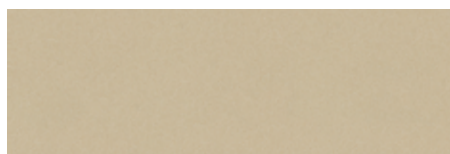

MOONDUST beige
19 x 59,4
MOONDUST beige polished
19 x 59,4



R10

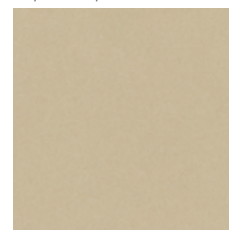

MOONDUST beige
29,55 x 29,55
MOONDUST beige polished
29,55 x 29,55



R10



MOONDUST mocca
19 x 59,4
MOONDUST mocca polished
19 x 59,4



R10

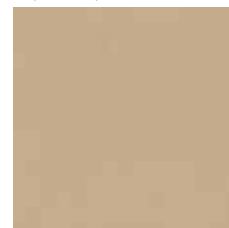

MOONDUST mocca
29,55 x 29,55
MOONDUST mocca polished
29,55 x 29,55



R10

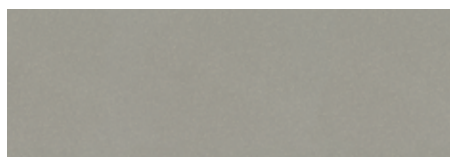

MOONDUST light grey
19 x 59,4
MOONDUST light grey polished
19 x 59,4



R10

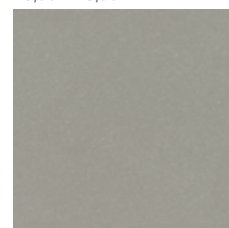

MOONDUST light grey
29,55 x 29,55
MOONDUST light grey polished
29,55 x 29,55



R10

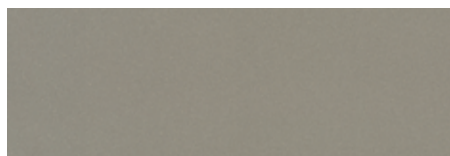

MOONDUST dark grey
19 x 59,4
MOONDUST dark grey polished
19 x 59,4



R10

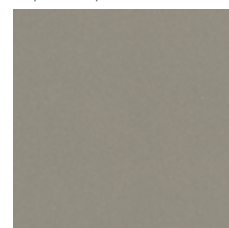

MOONDUST dark grey
29,55 x 29,55
MOONDUST dark grey polished
29,55 x 29,55



R10



MOONDUST black
19 x 59,4
MOONDUST black polished
19 x 59,4



R10

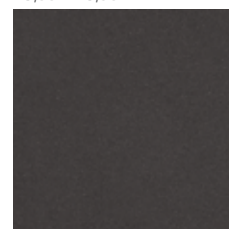

MOONDUST black
29,55 x 29,55
MOONDUST black polished
29,55 x 29,55



R10

**PŁYTKI
CERAMICZNE
CIĄGI
KOMUNIKACYJNE
CERAMIC
TILES
HIGH-TRAFFIC
AREAS**

URBAN MIX >

GRES
NIESZKLIWIONY
**UNGLAZED
PORCELAIN
TILES**

NOWOŚĆ/NEW

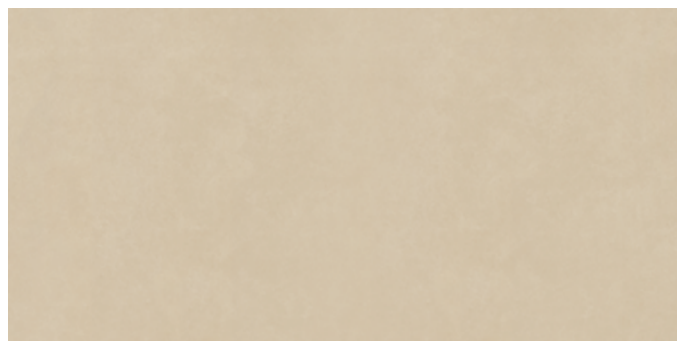

URBAN MIX cream
44,4 x 89
OP639-009-1



URBAN MIX cream
59,4 x 59,4
OP639-011-1



URBAN MIX cream
29,55 x 59,4
OP639-039-1

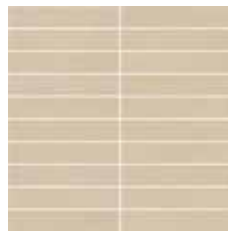

URBAN MIX cream mosaic
29,55 x 29,55
OD639-024



URBAN MIX cream steptread
29,55 x 59,4
OD639-026

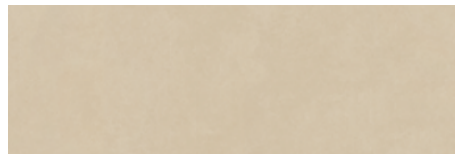

URBAN MIX cream
19 x 59,4
OP639-046-1



URBAN MIX cream skirting
7,2 x 59,4
OD639-025

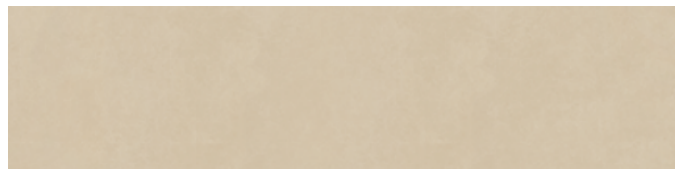

URBAN MIX cream
21,8 x 89
OP639-038-1

URBAN MIX >

GRES
NIESZKLIWIONY
UNGLAZED
PORCELAIN
TILES

NOWOŚĆ/NEW

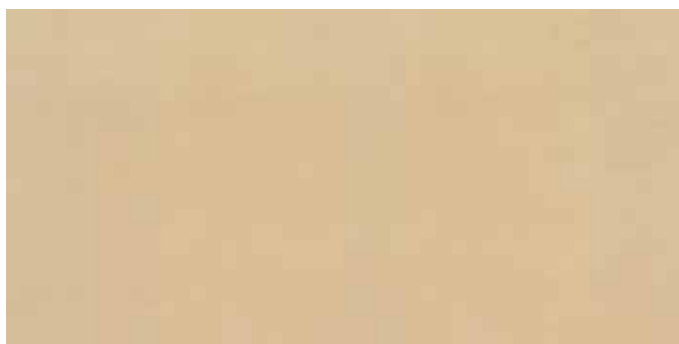

URBAN MIX beige
44,4 x 89
OP639-001-1



URBAN MIX beige
59,4 x 59,4
OP639-003-1



URBAN MIX beige
29,55 x 59,4
OP639-037-1

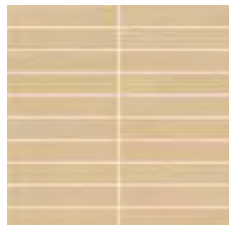

URBAN MIX beige mosaic
29,55 x 29,55
OD639-021



URBAN MIX beige steptread
29,55 x 59,4
OD639-023



URBAN MIX beige
19 x 59,4
OP639-047-1



URBAN MIX beige
21,8 x 89
OP639-036-1



URBAN MIX beige skirting
7,2 x 59,4
OD639-022

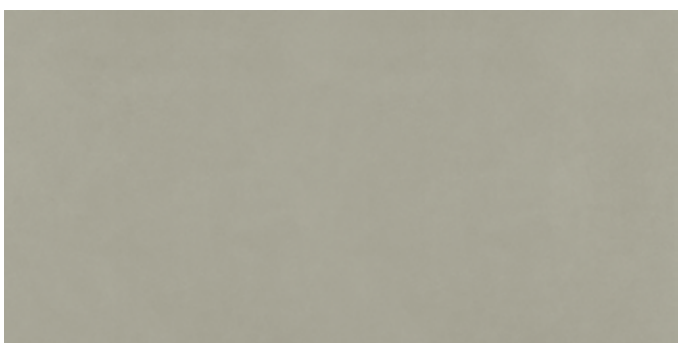

URBAN MIX light grey
44,4 x 89
OP639-017-1



URBAN MIX light grey
59,4 x 59,4
OP639-019-1

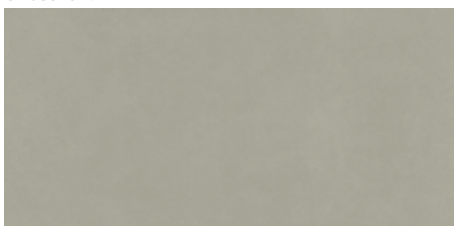

URBAN MIX light grey
29,55 x 59,4
OP639-045-1

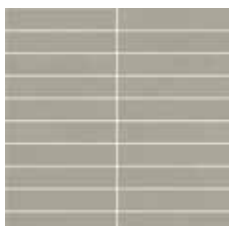

URBAN MIX light grey mosaic
29,55 x 29,55
OD639-033



URBAN MIX light grey steptread
29,55 x 59,4
OD639-035

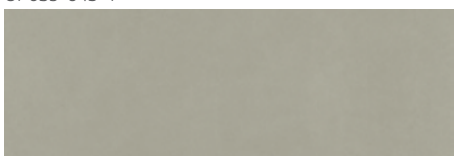

URBAN MIX light grey
19 x 59,4
OP639-048-1

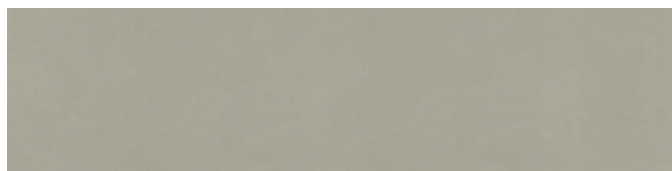

URBAN MIX light grey
21,8 x 89
OP639-044-1



URBAN MIX light grey skirting
7,2 x 59,4
OD639-034



**PŁYTKI
CERAMICZNE
CIĄGI
KOMUNIKACYJNE
CERAMIC
TILES
HIGH-TRAFFIC
AREAS**

URBAN MIX >

GRES
NIESZKLIWIONY
**UNGLAZED
PORCELAIN
TILES**

NOWOŚĆ/NEW



URBAN MIX grey
44,4 x 89
OP639-013-1



URBAN MIX grey
59,4 x 59,4
OP639-015-1

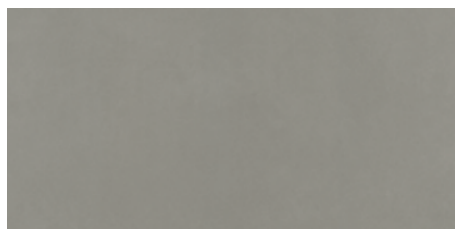

URBAN MIX grey
29,55 x 59,4
OP639-043-1

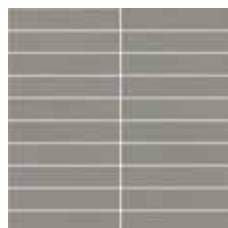

URBAN MIX grey mosaic
29,55 x 29,55
OD639-030



URBAN MIX grey steptread
29,55 x 59,4
OD639-032

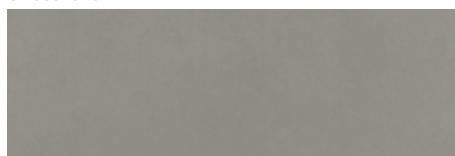

URBAN MIX grey
19 x 59,4
OP639-049-1



URBAN MIX grey skirting
7,2 x 59,4
OD639-031

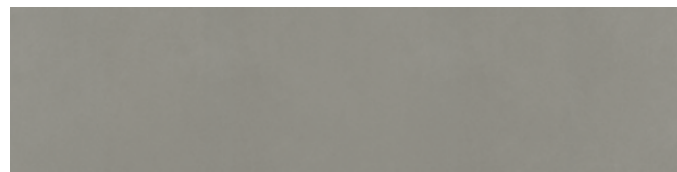

URBAN MIX grey
21,8 x 89
OP639-042-1

URBAN MIX >

GRES
NIESZKLIWIONY
UNGLAZED
PORCELAIN
TILES

NOWOŚĆ/NEW



URBAN MIX graphite
44,4 x 89
OP639-005-1



URBAN MIX graphite
59,4 x 59,4
OP639-007-1



URBAN MIX graphite
29,55 x 59,4
OP639-041-1

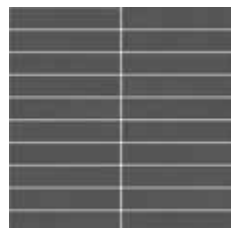

URBAN MIX graphite mosaic
29,55 x 29,55
OD639-027



URBAN MIX graphite steptread
29,55 x 59,4
OD639-029



URBAN MIX graphite
19 x 59,4
OP639-050-1



URBAN MIX graphite skirting
7,2 x 59,4
OD639-028



URBAN MIX graphite
21,8 x 89
OP639-040-1

URBAN MIX >

GRES
NIESZKLIWIONY
UNGLAZED
PORCELAIN
TILES

NOWOŚĆ/NEW

FORMATY NA SPECJALNE ZAMÓWIENIE
SPECIAL ORDER SIZES

O szczegóły zapytaj naszego przedstawiciela handlowego
Ask our sales representative for details

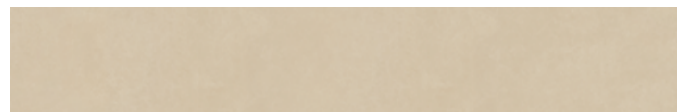

URBAN MIX cream
14,7 x 89



URBAN MIX cream
44,4 x 44,4



URBAN MIX cream
29,55 x 29,55



URBAN MIX beige
14,7 x 89



URBAN MIX beige
44,4 x 44,4

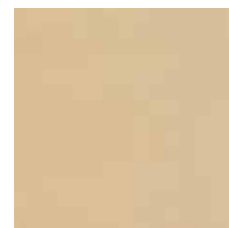

URBAN MIX beige
29,55 x 29,55



URBAN MIX >

GRES
NIESZKLIWIONY
**UNGLAZED
PORCELAIN
TILES**

NOWOŚĆ / NEW

FORMATY NA SPECJALNE ZAMÓWIENIE SPECIAL ORDER SIZES

O szczegóły zapytaj naszego przedstawiciela handlowego
Ask our sales representative for details

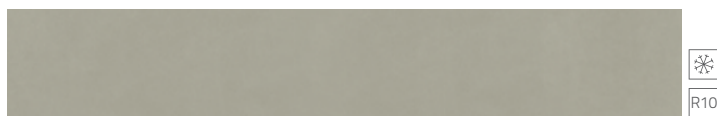

URBAN MIX light grey
14,7 x 89



URBAN MIX light grey
44,4 x 44,4

URBAN MIX light grey
29,55 x 29,55



URBAN MIX grey
14,7 x 89



URBAN MIX grey
44,4 x 44,4

URBAN MIX grey
29,55 x 29,55



URBAN MIX graphite
14,7 x 89



URBAN MIX graphite
44,4 x 44,4

URBAN MIX graphite
29,55 x 29,55

**PŁYTKI
CERAMICZNE
CIĄGI
KOMUNIKACYJNE
CERAMIC
TILES
HIGH-TRAFFIC
AREAS**

DRY RIVER >

GRES
NIESZKLIWIONY
UNGLAZED
PORCELAIN
TILES

NOWOŚĆ/NEW



DRY RIVER cream
44,4 x 89
OP622-039-1



DRY RIVER cream mosaic
29,55 x 29,55
OD622-031



DRY RIVER cream
29,55 x 59,4
OP622-007-1



DRY RIVER cream
59,4 x 59,4
OP622-001-1



DRY RIVER cream steptread
29,55 x 59,4
OD622-013



DRY RIVER cream skirting
7,2 x 59,4
OD622-019



DRY RIVER beige
44,4 x 89
OP622-037-1

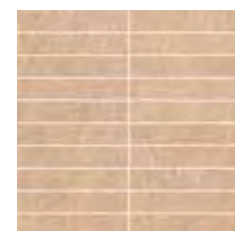

DRY RIVER beige mosaic
29,55 x 29,55
OD622-032



DRY RIVER beige
29,55 x 59,4
OP622-008-1



DRY RIVER beige
59,4 x 59,4
OP622-002-1



DRY RIVER beige steptread
29,55 x 59,4
OD622-014



DRY RIVER beige skirting
7,2 x 59,4
OD622-020

DRY RIVER >

GRES
NIESZKLIWIONY
UNGLAZED
PORCELAIN
TILES

NOWOŚĆ/NEW



DRY RIVER light grey
44,4 x 89
OP622-042-1



DRY RIVER light grey mosaic
29,55 x 29,55
OD622-034



DRY RIVER light grey
29,55 x 59,4
OP622-010-1



DRY RIVER light grey
59,4 x 59,4
OP622-004-1



DRY RIVER light grey step-tread
29,55 x 59,4
OD622-016



DRY RIVER light grey skirting
7,2 x 59,4
OD622-022



DRY RIVER grey
44,4 x 89
OP622-041-1

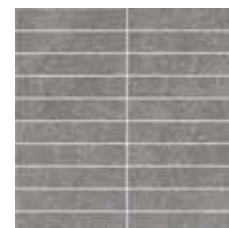

DRY RIVER grey mosaic
29,55 x 29,55
OD622-035



DRY RIVER grey
29,55 x 59,4
OP622-011-1



DRY RIVER grey
59,4 x 59,4
OP622-005-1



DRY RIVER grey step-tread
29,55 x 59,4
OD622-017



DRY RIVER grey skirting
7,2 x 59,4
OD622-023

PRE
STI
GE

**PŁYTKI
CERAMICZNE
CIĄGI
KOMUNIKACYJNE
CERAMIC
TILES
HIGH-TRAFFIC
AREAS**

DRY RIVER >

GRES
NIESZKLIWIONY
UNGLAZED
PORCELAIN
TILES

NOWOŚĆ/NEW



DRY RIVER brown
44,4 x 89
OP622-038-1

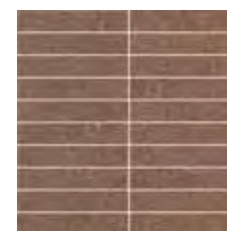

DRY RIVER brown mosaic
29,55 x 29,55
OD622-033



DRY RIVER brown
29,55 x 59,4
OP622-009-1



DRY RIVER brown
59,4 x 59,4
OP622-003-1



DRY RIVER brown steptread
29,55 x 59,4
OD622-015



DRY RIVER brown skirting
7,2 x 59,4
OD622-021



DRY RIVER graphite
44,4 x 89
OP622-040-1



DRY RIVER graphite mosaic
29,55 x 29,55
OD622-036



DRY RIVER graphite
29,55 x 59,4
OP622-012-1



DRY RIVER graphite
59,4 x 59,4
OP622-006-1



DRY RIVER graphite steptread
29,55 x 59,4
OD622-018



DRY RIVER graphite skirting
7,2 x 59,4
OD622-024

FORMATY NA SPECJALNE ZAMÓWIENIE SPECIAL ORDER SIZES

O szczegóły zapytaj naszego przedstawiciela handlowego
Ask our sales representative for details



DRY RIVER cream
19 x 59,4



DRY RIVER cream
29,55 x 29,55



DRY RIVER cream
21,8 x 89



DRY RIVER cream
44,4 x 44,4



DRY RIVER cream
14,7 x 89



DRY RIVER beige
19 x 59,4



DRY RIVER beige
29,55 x 29,55

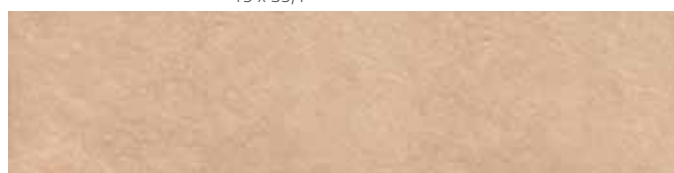

DRY RIVER beige
21,8 x 89



DRY RIVER beige
44,4 x 44,4



DRY RIVER beige
14,7 x 89



DRY RIVER brown
19 x 59,4



DRY RIVER brown
29,55 x 29,55

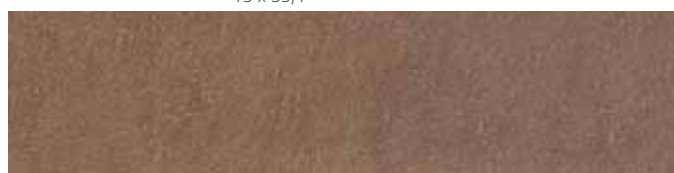

DRY RIVER brown
21,8 x 89



DRY RIVER brown
44,4 x 44,4



DRY RIVER brown
14,7 x 89

**FORMATY NA SPECJALNE ZAMÓWIENIE
SPECIAL ORDER SIZES**

O szczegóły zapytaj naszego przedstawiciela handlowego
Ask our sales representative for details



DRY RIVER light grey
19 x 59,4



R10



DRY RIVER light grey
29,55 x 29,55



R10



DRY RIVER light grey
21,8 x 89



R10



DRY RIVER light grey
44,4 x 44,4



R10

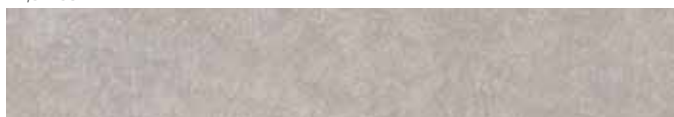

DRY RIVER light grey
14,7 x 89



R10



DRY RIVER grey
19 x 59,4



R10



DRY RIVER grey
29,55 x 29,55



R10



DRY RIVER grey
21,8 x 89



R10



DRY RIVER grey
44,4 x 44,4



R10



DRY RIVER grey
14,7 x 89



R10



DRY RIVER graphite
19 x 59,4



R10



DRY RIVER graphite
29,55 x 29,55



R10



DRY RIVER graphite
21,8 x 89



R10



DRY RIVER graphite
44,4 x 44,4



R10



DRY RIVER graphite
14,7 x 89



R10

DUSK >

GRES
SZKLIWIONY
**GLAZED
PORCELAIN
TILES**

NOWOŚĆ / NEW



DUSK grey
44,4 x 89
OP637-009-1



DUSK grey
29 x 59,3
OP637-019-1



DUSK grey textile
29 x 59,3
OP637-020-1



DUSK grey textile
44,4 x 89
OP637-013-1



DUSK grey
59,3 x 59,3
OP637-011-1



DUSK grey mosaic
29 x 29,5
OD637-022



DUSK grey textile
59,3 x 59,3
OP637-015-1

**PŁYTKI
CERAMICZNE
CIĄGI
KOMUNIKACYJNE
CERAMIC
TILES
HIGH-TRAFFIC
AREAS**

DUSK >

GRES
SZKLIWIONY
**GLAZED
PORCELAIN
TILES**

NOWOŚĆ / NEW



DUSK beige
59,3 x 59,3
OP637-003-1



DUSK beige
44,4 x 89
OP637-001-1

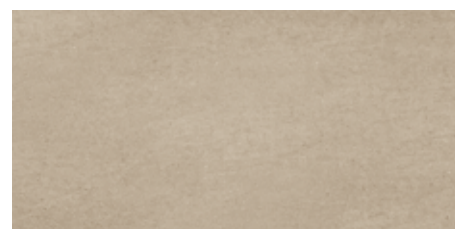

DUSK beige
29 x 59,3
OP637-017-1



DUSK beige mosaic
29 x 29,5
OD637-021



DUSK beige textile
29 x 59,3
OP637-018-1



DUSK beige textile
59,3 x 59,3
OP637-007-1



DUSK beige textile
44,4 x 89
OP637-005-1



DUSK >
 GRES
 SZKLIWIONY
**GLAZED
 PORCELAIN
 TILES**
 NOWOŚĆ/NEW

**FORMATY NA SPECJALNE ZAMÓWIENIE
 SPECIAL ORDER SIZES**

O szczegóły zapytaj naszego przedstawiciela handlowego
 Ask our sales representative for details



DUSK grey
 14,4 x 59,3



DUSK grey textile
 14,4 x 59,3



DUSK grey
 21,8 x 89



DUSK grey textile
 21,8 x 89



DUSK grey
 14,7 x 89



DUSK grey textile
 14,7 x 89



DUSK grey
 29 x 29



DUSK grey textile
 29 x 29



DUSK grey
 44,4 x 44,4



DUSK grey textile
 44,4 x 44,4



DUSK >

GRES
SZKLIWIONY
**GLAZED
PORCELAIN
TILES**

NOWOŚĆ / NEW

**FORMATY NA SPECJALNE ZAMÓWIENIE
SPECIAL ORDER SIZES**

O szczegóły zapytaj naszego przedstawiciela handlowego
Ask our sales representative for details



DUSK beige
14,4 x 59,3



DUSK beige textile
14,4 x 59,3

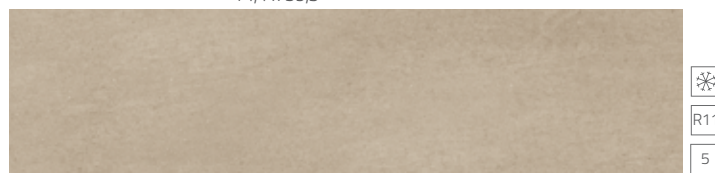

DUSK beige
21,8 x 89



DUSK beige textile
21,8 x 89

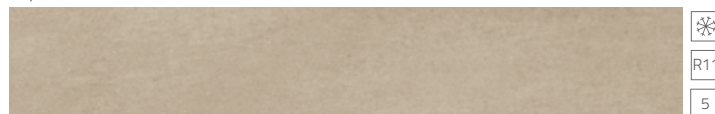

DUSK beige
14,7 x 89



DUSK beige textile
14,7 x 89



DUSK beige
29 x 29

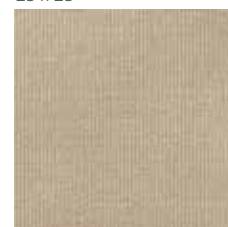

DUSK beige textile
29 x 29



DUSK beige
44,4 x 44,4



DUSK beige textile
44,4 x 44,4



EQUINOX >

GRES
SZKLIWIONY
GLAZED
PORCELAIN
TILES

NOWOŚĆ / NEW

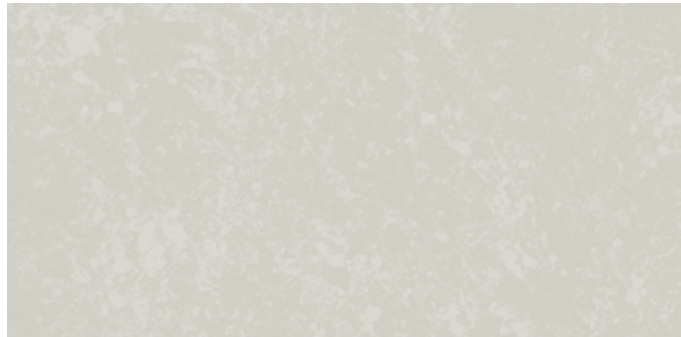

EQUINOX white
44,4 x 89
OP638-005-1



EQUINOX white
21,8 x 89
OP638-014-1



EQUINOX white mosaic square
29 x 29
OD638-011



EQUINOX white
59,3 x 59,3
OP638-007-1



EQUINOX mix mosaic belt
29 x 29,5
OD638-020

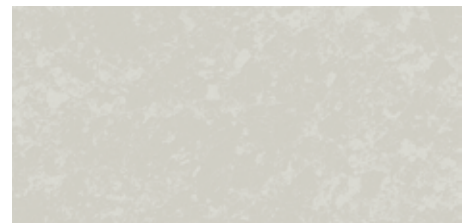

EQUINOX white
29 x 59,3
OP638-015-1

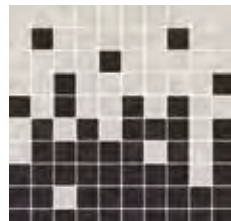

EQUINOX mix mosaic square
29 x 29
OD638-010



EQUINOX white skirting
7,2 x 59,3
OD638-018



EQUINOX white border
2 x 59,3
OD638-016

**PŁYTKI
CERAMICZNE
CIĄGI
KOMUNIKACYJNE
CERAMIC
TILES
HIGH-TRAFFIC
AREAS**

EQUINOX >

GRES
SZKLIWIONY
**GLAZED
PORCELAIN
TILES**

NOWOŚĆ/NEW

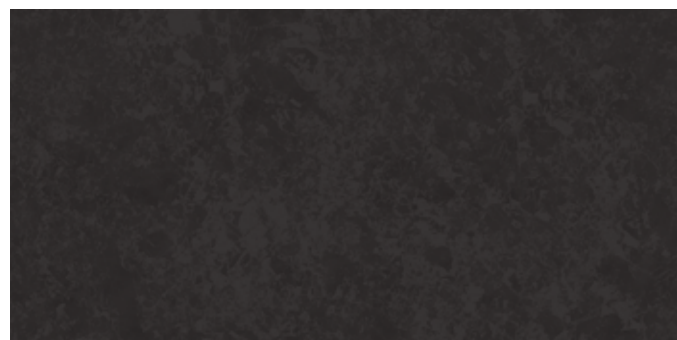

EQUINOX black
44,4 x 89
OP638-001-1



EQUINOX black
21,8 x 89
OP638-012-1

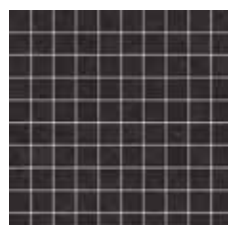

EQUINOX black mosaic square
29 x 29
OD638-009

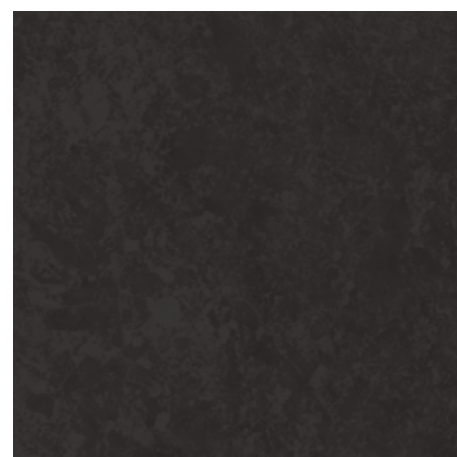

EQUINOX black
59,3 x 59,3
OP638-003-1



EQUINOX mix mosaic belt
29 x 29,5
OD638-020

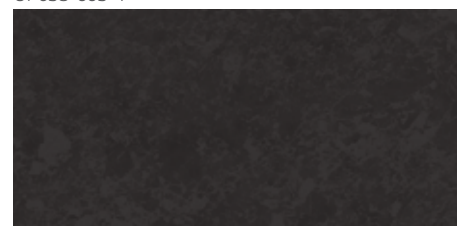

EQUINOX black
29 x 59,3
OP638-013-1

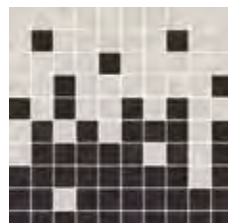

EQUINOX mix mosaic square
29 x 29
OD638-010



EQUINOX black skirting
7,2 x 59,3
OD638-019



EQUINOX black border
2 x 59,3
OD638-017

◀ EQUINOX

GRES SZKLIWIONY
GLAZED PORCELAIN TILES

NOWOŚĆ/NEW

FORMATY NA SPECJALNE ZAMÓWIENIE SPECIAL ORDER SIZES

O szczegóły zapytaj naszego przedstawiciela handlowego
Ask our sales representative for details

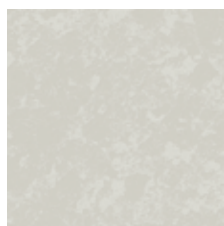

EQUINOX white
29 x 29

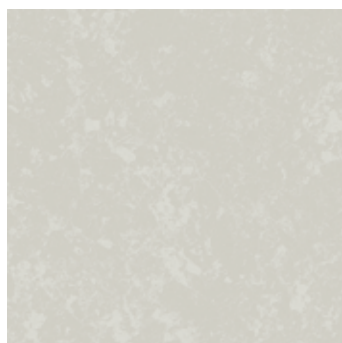

EQUINOX white
44,4 x 44,4

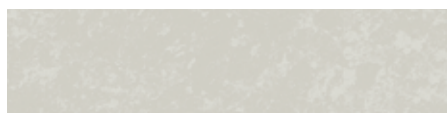

EQUINOX white
14,4 x 59,3

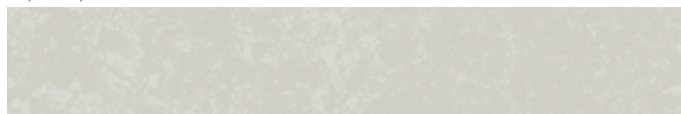

EQUINOX white
14,7 x 89

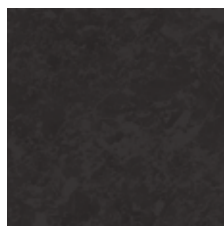

EQUINOX black
29 x 29

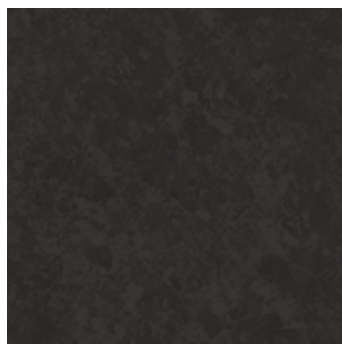

EQUINOX black
44,4 x 44,4



EQUINOX black
14,4 x 59,3



EQUINOX black
14,7 x 89



YAKARA >

GRES
SZKLIWIONY
GLAZED
PORCELAIN
TILES

SMART
SILVER



YAKARA white
44,6 x 89,5
MT002-007-1



YAKARA white
44,6 x 44,6
MT002-010-1



DAINO >

GRES
SZKLIWIONY
GLAZED
PORCELAIN
TILES

SMART
SILVER



DAINO cream
44,6 x 89,5
MT001-001-1



DAINO cream
44,6 x 44,6
MT001-002-1



**PŁYTKI
CERAMICZNE
CIĄGI
KOMUNIKACYJNE
CERAMIC
TILES
HIGH-TRAFFIC
AREAS**

KANDO >

GRES
NIESZKLIWIONY
UNGLAZED
PORCELAIN
TILES



KANDO off-white
59,4 x 59,4
W164-268-1
KANDO off-white polished
W164-269-1



KANDO grey
59,4 x 59,4
W164-172-1
KANDO grey polished
W164-092-1



KANDO off-white
29,55 x 59,4
W164-270-1
KANDO off-white polished
W164-271-1



KANDO grey
29,55 x 59,4
W164-165-1
KANDO grey polished
W164-106-1



KANDO off-white step tread
29,55 x 59,4
WD164-272
KANDO off-white step tread polished
WD164-273



KANDO grey step tread
29,55 x 59,4
WD164-154
KANDO grey step tread polished
WD164-140



KANDO off-white skirting
7,2 x 59,4
WD164-283
KANDO off-white skirting polished
WD164-284



KANDO grey skirting
7,2 x 59,4
WD164-282
KANDO grey skirting polished
WD164-282



KANDO off-white mosaic strips satin
14,7 x 41
WD164-274



KANDO grey mosaic strips
14,7 x 41
WD164-067

**FORMATY NA SPECJALNE ZAMÓWIENIE
SPECIAL ORDER SIZES**

O szczegóły zapytaj naszego przedstawiciela handlowego
Ask our sales representative for details

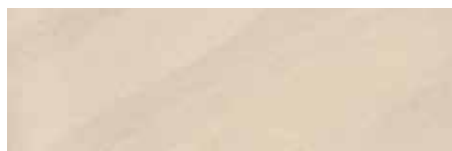

KANDO off-white
19 x 59,4



KANDO grey
19 x 59,4

KANDO >

GRES
NIESZKLIWIONY
UNGLAZED
PORCELAIN
TILES



KANDO graphite
59,4 x 59,4
W164-247-1
KANDO graphite polished
W164-251-1



KANDO anthracite
59,4 x 59,4
W164-244-1
KANDO anthracite polished
W164-250-1

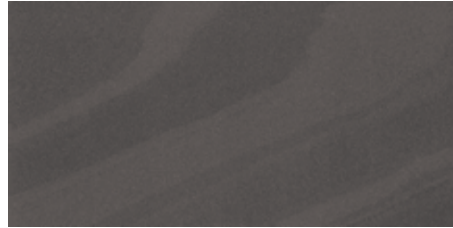

KANDO graphite
29,55 x 59,4
W164-248-1
KANDO graphite polished
W164-253-1



KANDO anthracite
29,55 x 59,4
W164-245-1
KANDO anthracite polished
W164-252-1



KANDO graphite steptread
29,55 x 59,4
W164-265-1
KANDO graphite steptread polished
W164-263-1



KANDO anthracite steptread
29,55 x 59,4
W164-264-1
KANDO anthracite steptread polished
W164-262-1



KANDO graphite skirting
7,2 x 59,4
WD164-280
KANDO graphite skirting polished
WD164-279



KANDO anthracite skirting
7,2 x 59,4
WD164-278
KANDO anthracite skirting polished
WD164-277



KANDO graphite mosaic strips
14,7 x 41
WD164-261



KANDO anthracite mosaic strips
14,7 x 41
WD164-260

FORMATY NA SPECJALNE ZAMÓWIENIE SPECIAL ORDER SIZES

O szczegóły zapytaj naszego przedstawiciela handlowego
Ask our sales representative for details



KANDO graphite
19 x 59,4



KANDO anthracite
19 x 59,4

* R10 - dotyczy płytek matowych / only matt tiles

PRE
STIGE

**PŁYTKI
CERAMICZNE
CIĄGI
KOMUNIKACYJNE
CERAMIC
TILES
HIGH-TRAFFIC
AREAS**

KALLISTO >

GRES
NIESZKLIWIONY
**UNGLAZED
PORCELAIN
TILES**



KALLISTO cream, 59,8 x 59,8
OP075-070-1
KALLISTO cream polished, 59,4 x 59,4
OP075-090-1
KALLISTO cream rect., 59,4 x 59,4
OP075-078-1



KALLISTO beige, 59,8 x 59,8
OP075-071-1
KALLISTO beige polished, 59,4 x 59,4
OP075-091-1
KALLISTO beige rect., 59,4 x 59,4
OP075-079-1



KALLISTO cream, 29,7 x 59,8
OP075-074-1
KALLISTO cream polished, 29,55 x 59,4
OP075-086-1
KALLISTO cream rect., 29,55 x 59,4
OP075-082-1

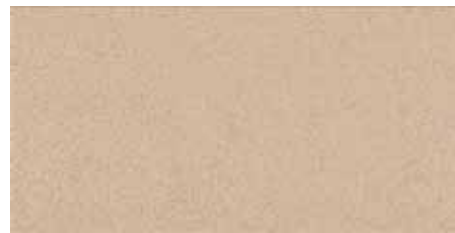

KALLISTO beige, 29,7 x 59,8
OP075-075-1
KALLISTO beige polished, 29,55 x 59,4
OP075-087-1
KALLISTO beige rect., 29,55 x 59,4
OP075-083-1



KALLISTO cream steptread
29,7 x 59,8
OP075-094-1



KALLISTO beige steptread
29,7 x 59,8
OP075-095-1



KALLISTO cream skirting
7,2 x 59,4
OP075-098



KALLISTO beige skirting
7,2 x 59,4
OP075-099

KALLISTO >

GRES
NIESZKLIWIONY
UNGLAZED
PORCELAIN
TILES



KALLISTO grey, 59,8 x 59,8
OP075-072-1
KALLISTO grey polished 59,4 x 59,4
OP075-092-1
KALLISTO grey rect. 59,4 x 59,4
OP075-080-1

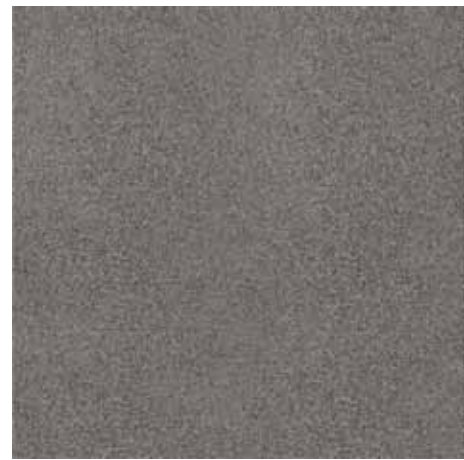

KALLISTO graphite, 59,8 x 59,8
OP075-073-1
KALLISTO graphite polished 59,4 x 59,4
OP075-093-1
KALLISTO graphite rect. 59,4 x 59,4
OP075-081-1



KALLISTO grey, 29,7 x 59,8
OP075-076-1
KALLISTO grey polished, 29,55 x 59,4
OP075-088-1
KALLISTO grey rect., 29,55 x 59,4
OP075-084-1



KALLISTO graphite, 29,7 x 59,8
OP075-077-1
KALLISTO graphite polished, 29,55 x 59,4
OP075-089-1
KALLISTO graphite rect., 29,55 x 59,4
OP075-085-1



KALLISTO grey steptread
29,7 x 59,8
OP075-096-1



KALLISTO graphite steptread
29,7 x 59,8
OP075-097-1



KALLISTO grey skirting
7,2 x 59,4
OP075-100



KALLISTO graphite skirting
7,2 x 59,4
OP075-101

* R10 - dotyczy płytek matowych

**PŁYTKI
CERAMICZNE
CIĄGI
KOMUNIKACYJNE
CERAMIC
TILES
HIGH-TRAFFIC
AREAS**

MILTON >

GRES
SZKLIWIONY
GLAZED
PORCELAIN
TILES



MILTON beige
29,7 x 29,7
OP069-001-1



MILTON beige steptread
29,7 x 29,7
OP069-002-1



MILTON grey
29,7 x 29,7
OP069-011-1



MILTON grey steptread
29,7 x 29,7
OP069-012-1

**KALLISTO >
12 mm**

GRES
NIESZKLIWIONY
UNGLAZED
PORCELAIN
TILES



KALLISTO cream 12mm
20 x 20
OP075-022-1



KALLISTO cream anti-slip 12mm
20 x 20
OP075-023-1



KALLISTO beige 12mm
20 x 20
OP075-045-1



KALLISTO grey 12mm
20 x 20
OP075-043-1



KALLISTO grey anti-slip 12mm
20 x 20
OP075-046-1



KALLISTO graphite 12mm
20 x 20
OP075-044-1

KALLISTO >

GRES
NIESZKLIWIONY
UNGLAZED
PORCELAIN
TILES

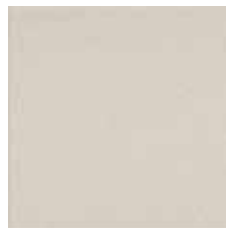

KALLISTO K3 cream
29,7 x 29,7
OP075-004-1
KALLISTO K3 cream polished
29,5 x 29,5
OP075-102-1

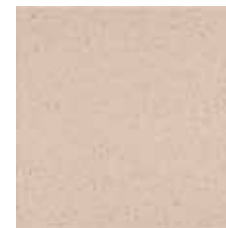

KALLISTO K4 beige
29,7 x 29,7
OP075-007-1
KALLISTO K4 beige polished
29,5 x 29,5
OP075-103-1



KALLISTO K3 cream steptread
29,7 x 29,7
OP075-006-1

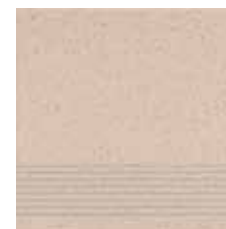

KALLISTO K4 beige steptread
29,7 x 29,7
OP075-009-1

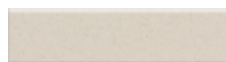

KALLISTO K3 cream skirting
7,2 x 29,7
OD075-026



KALLISTO K4 beige skirting
7,2 x 29,7
OD075-027

KALLISTO >

GRES
NIESZKLIWIONY
UNGLAZED
PORCELAIN
TILES



KALLISTO K2 yellow
29,7 x 29,7
OP075-047-1
KALLISTO K2 yellow polished
29,5 x 29,5
OP075-104-1



KALLISTO K6 terracotta
29,7 x 29,7
OP075-011-1
KALLISTO K6 terracotta polished
29,5 x 29,5
OP075-105-1



KALLISTO K5 brown
29,7 x 29,7
OP075-054-1
KALLISTO K5 brown polished
29,5 x 29,5
OP075-106-1



KALLISTO K10 graphite
29,7 x 29,7
OP075-001-1
KALLISTO K10 graphite polished
29,5 x 29,5
OP075-108-1



KALLISTO K2 yellow steptread
29,7 x 29,7
OP075-051-1



KALLISTO K6 terracotta steptread
29,7 x 29,7
OP075-012-1



KALLISTO K5 brown steptread
29,7 x 29,7
OP075-055-1



KALLISTO K10 graphite steptread
29,7 x 29,7
OP075-003-1



KALLISTO K2 yellow skirting
7,2 x 29,7
OD075-049



KALLISTO K6 terracotta skirting
7,2 x 29,7
OD075-028

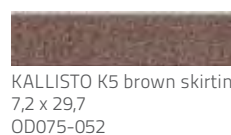

KALLISTO K5 brown skirting
7,2 x 29,7
OD075-052



KALLISTO K10 graphite skirting
7,2 x 29,7
OD075-024



KALLISTO K9 grey
29,7 x 29,7
OP075-019-1
KALLISTO K9 grey polished
29,5 x 29,5
OP075-109-1



KALLISTO K7 green
29,7 x 29,7
OP075-013-1
KALLISTO K7 green polished
29,5 x 29,5
OP075-110-1



KALLISTO K8 blue
29,7 x 29,7
OP075-018-1
KALLISTO K8 blue polished
29,5 x 29,5
OP075-111-1



KALLISTO K11 black
29,7 x 29,7
OP075-059-1
KALLISTO K11 black polished
29,5 x 29,5
OP075-107-1



KALLISTO K9 grey steptread
29,7 x 29,7
OP075-021-1

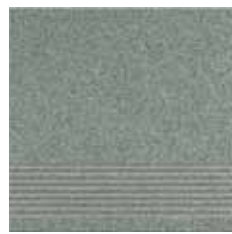

KALLISTO K7 green steptread
29,7 x 29,7
OP075-015-1

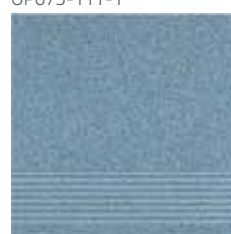

KALLISTO K8 blue steptread
29,7 x 29,7
OP075-017-1

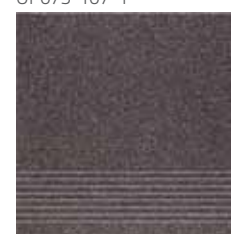

KALLISTO K11 black steptread
29,7 x 29,7
OP075-060-1

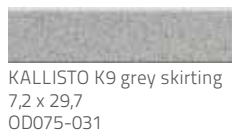

KALLISTO K9 grey skirting
7,2 x 29,7
OD075-031



KALLISTO K7 green skirting
7,2 x 29,7
OD075-029

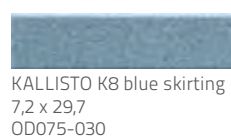

KALLISTO K8 blue skirting
7,2 x 29,7
OD075-030



KALLISTO K11 black skirting
7,2 x 29,7
OD075-057



* R10 - dotyczy płytek matowych

STANDARD

**PŁYTKI
CERAMICZNE
CIĄGI
KOMUNIKACYJNE
CERAMIC
TILES
HIGH-TRAFFIC
AREAS**

HYPERION >

GRES
NIESZKLIWIONY
UNGLAZED
PORCELAIN
TILES



HYPERION H3 cream
29,7 x 29,7 – OP074-005-1
HYPERION H3 cream polished
29,5 x 29,5 – OP074-079-1



HYPERION H4 beige
29,7 x 29,7 – OP074-009-1
HYPERION H4 beige polished
29,5 x 29,5 – OP074-080-1



HYPERION H3 cream 3d
29,7 x 29,7
OP074-006-1



HYPERION H4 beige 3d
29,7 x 29,7
OP074-010-1



HYPERION H3 cream steptread
29,7 x 29,7
OP074-008-1



HYPERION H4 beige steptread
29,7 x 29,7
OP074-012-1



HYPERION H3 cream skirting
7,2 x 29,7
OD074-030



HYPERION H4 beige skirting
7,2 x 29,7
OD074-031

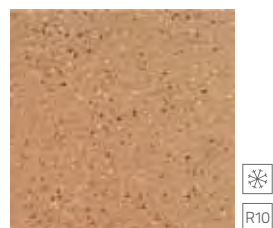

HYPERION H2 yellow
29,7 x 29,7 – OP074-053-1
HYPERION H2 yellow polished
29,5 x 29,5 – OP074-078-1



HYPERION H6 terracotta
29,7 x 29,7 – OP074-014-1
HYPERION H6 terracotta polished
29,5 x 29,5 – OP074-082-1

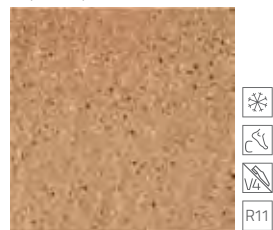

HYPERION H2 yellow 3d
29,7 x 29,7
OP074-056-1

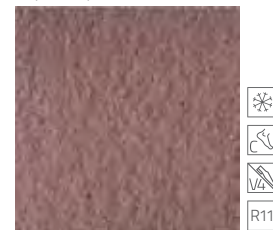

HYPERION H6 terracotta 3d
29,7 x 29,7
OP074-015-1

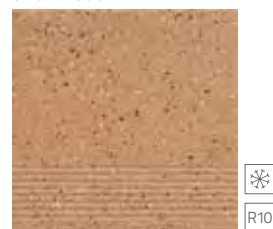

HYPERION H2 yellow steptread
29,7 x 29,7
OP074-055-1



HYPERION H6 terracotta steptread
29,7 x 29,7
OP074-016-1



HYPERION H2 yellow skirting
7,2 x 29,7
OD074-065



HYPERION H6 terracotta skirting
7,2 x 29,7
OD074-032

HYPERION >

GRES
NIESZKLIWIONY
UNGLAZED
PORCELAIN
TILES



HYPERION H11 black
29,7 x 29,7 – OP074-061-1
HYPERION H11 black polished
29,5 x 29,5 – OP074-077-1



HYPERION H5 brown
29,7 x 29,7 – OP074-057-1
HYPERION H5 brown polished
29,5 x 29,5 – OP074-081-1



HYPERION H10 graphite
29,7 x 29,7 – OP074-001-1
HYPERION H10 graphite polished
29,5 x 29,5 – OP074-076-1

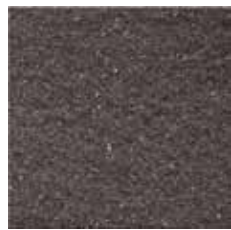

HYPERION H11 black 3d
29,7 x 29,7
OP074-064-1



HYPERION H5 brown 3d
29,7 x 29,7
OP074-060-1



HYPERION H10 graphite 3d
29,7 x 29,7
OP074-002-1



HYPERION H11 black steptread
29,7 x 29,7
OP074-063-1



HYPERION H5 brown steptread
29,7 x 29,7
OP074-059-1



HYPERION H10 graphite steptread
29,7 x 29,7
OP074-004-1



HYPERION H11 black skirting
7,2 x 29,7
OD074-067



HYPERION H5 brown skirting
7,2 x 29,7
OD074-066



HYPERION H10 graphite skirting
7,2 x 29,7
OD074-029



HYPERION H9 grey
29,7 x 29,7 – OP074-025-1
HYPERION H9 grey polished
29,5 x 29,5 – OP074-085-1



HYPERION H7 green
29,7 x 29,7 – OP074-017-1
HYPERION H7 green polished
29,5 x 29,5 – OP074-083-1



HYPERION H8 blue
29,7 x 29,7 – OP074-023-1
HYPERION H8 blue polished
29,5 x 29,5 – OP074-084-1

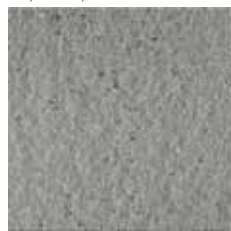

HYPERION H9 grey 3d
29,7 x 29,7
OP074-026-1



HYPERION H7 green 3d
29,7 x 29,7
OP074-018-1



HYPERION H8 blue 3d
29,7 x 29,7
OP074-024-1



HYPERION H9 grey steptread
29,7 x 29,7
OP074-028-1

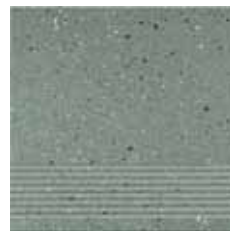

HYPERION H7 green steptread
29,7 x 29,7
OP074-020-1

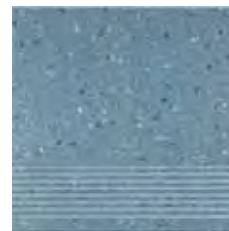

HYPERION H8 blue steptread
29,7 x 29,7
OP074-022-1



HYPERION H9 grey skirting
7,2 x 29,7
OD074-035



HYPERION H7 green skirting
7,2 x 29,7
OD074-033



HYPERION H8 blue skirting
7,2 x 29,7
OD074-034

STAN
DARD

* R10 - dotyczy płytek matowych

**PŁYTKI
CERAMICZNE
CIĄGI
KOMUNIKACYJNE
CERAMIC
TILES
HIGH-TRAFFIC
AREAS**

**HX200 >
KX300
RX400**

GRES
NIESZKLIWIONY
**UNGLAZED
PORCELAIN
TILES**

NOWOŚĆ/NEW



HX200
29,7 x 29,7
W334-004-1



HX200 stepread
29,7 x 29,7
W334-005-1



HX200 structure
29,7 x 29,7
W334-006-1



KX300
29,7 x 29,7
W335-004-1



KX300 stepread
29,7 x 29,7
W335-005-1



KX300 structure
29,7 x 29,7
W335-006-1



RX400
29,7 x 29,7
W336-004-1



RX400 stepread
29,7 x 29,7
W336-005-1



RX400 structure
29,7 x 29,7
W336-006-1

**< LOTOS
MONT BLANC
MONTE ROSA
MOUNT EVEREST
ETNA**

GRES
NIESZKLIWIONY
**UNGLAZED
PORCELAIN
TILES**

NOWOŚĆ/NEW



MONT BLANC
30 x 30
W005-001-1



MONTE ROSA
30 x 30
W011-001-1



MOUNT EVEREST
30 x 30
W006-001-1



ETNA
30 x 30
W002-001-1



MONT BLANC stepread
30 x 30
W005-003-1



MONTE ROSA stepread
30 x 30
W011-004-1



MOUNT EVEREST stepread
30 x 30
W006-003-1



ETNA stepread
30 x 30
W002-003-1



LOTOS
30 x 30
W008-001-1



MONT BLANC structure
30 x 30
W005-002-1



MONTE ROSA structure
30 x 30
W011-003-1

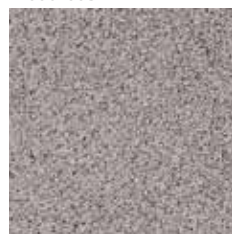

MOUNT EVEREST structure
30 x 30
W006-002-1

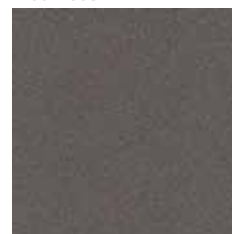

ETNA structure
30 x 30
W002-002-1



MONT BLANC skirting
8 x 30
WD005-015



MONTE ROSA skirting
8 x 30
WD011-007



MOUNT EVEREST skirting
8 x 30
WD006-007



ETNA skirting
8 x 30
WD002-005

A100 >
H200
K300
R400
N500

GRES
 NIESZKLIWIONY
**UNGLAZED
 PORCELAIN
 TILES**



A100
 30 × 30
 W 121-001-1



A100 steptread
 30 × 30
 W 121-002-1



A100 structure
 30 × 30
 W 121-003-1



H200
 30 × 30
 W 120-001-1

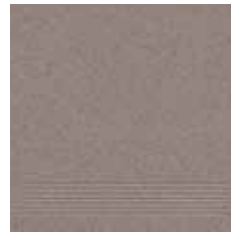

H200 steptread
 30 × 30
 W 120-002-1



H200 structure
 30 × 30
 W 120-003-1



K300
 30 × 30
 W 122-001-1



K300 steptread
 30 × 30
 W 122-002-1



K300 structure
 30 × 30
 W 122-003-1



R400
 30 × 30
 W 123-001-1



R400 steptread
 30 × 30
 W 123-002-1



R400 structure
 30 × 30
 W 123-003-1



N500
 30 × 30
 W 263-001-1



PŁYTKI
CERAMICZNE
ŁAZIENKI
PUBLICZNE
CERAMIC
TILES
RESTROOMS

N^o 2

Łazienki
ogólnodostępne
oraz pomieszczenia
socjalne
w obiektach
użyteczności
publicznej
Public
bathrooms
and social
rooms
in public-access
buildings

PŁYTKI
CERAMICZNE
ŁAZIENKI
PUBLICZNE
CERAMIC
TILES
RESTROOMS





Ceramika sanitarna: umywalki Ontario,
miska zawieszana Delfi
Płytki: Karoo cream
Sanitary ceramics: Ontario washbasin,
Delfi wall hung bowl
Ceramic tiles: Karoo cream

**PŁYTKI
CERAMICZNE**
ŁAZIENKI
PUBLICZNE
CERAMIC
TILES
RESTROOMS

ARKOS >

GRES
SZKLIWIONY
**GLAZED
PORCELAIN
TILES**

SMART
SILVER



ARKOS cream lappato
44,6 x 89,5
MT005-001-1



ARKOS cream lappato
44,6 x 44,6
MT005-002-1



ARKOS cream mosaic
22,2 x 44,6
MD005-008

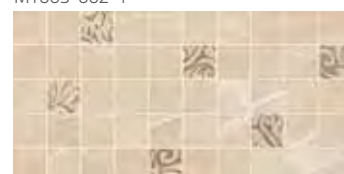

ARKOS cream mosaic classic
22,2 x 44,4
MD005-006

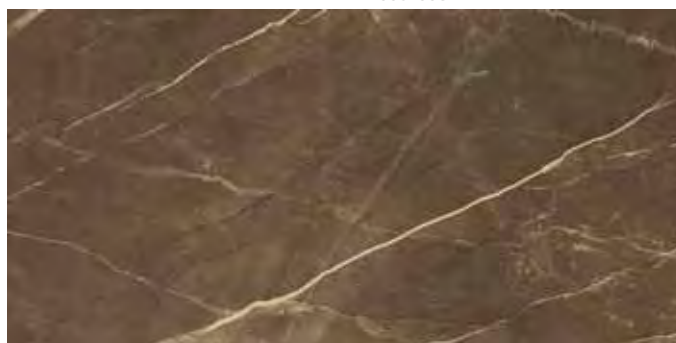

ARKOS brown lappato
44,6 x 89,5
MT005-003-1



ARKOS brown lappato
44,6 x 44,6
MT005-004-1

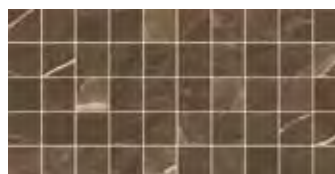

ARKOS brown mosaic
22,2 x 44,6
MD005-007

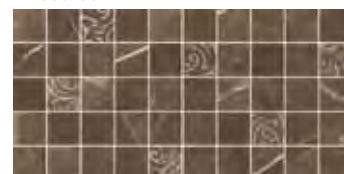

ARKOS brown mosaic classic
22,2 x 44,6
MD005-005





DAINO cream
44,6 x 89,5
MT001-001-1



DAINO beige
44,6 x 89,5
MT001-005-1



DAINO cream lappato
44,6 x 89,5
MT001-003-1



DAINO beige lappato
44,6 x 89,5
MT001-006-1



DAINO cream structure
44,6 x 89,5
MT001-010-1



DAINO beige structure
44,6 x 89,5
MT001-009-1



DAINO cream
44,6 x 44,6
MT001-002-1



DAINO beige
44,6 x 44,6
MT001-007-1

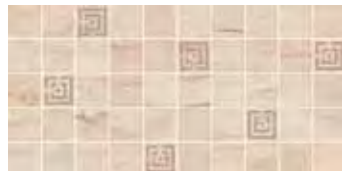

DAINO cream mosaic classic
22,2 x 44,6
MD001-016

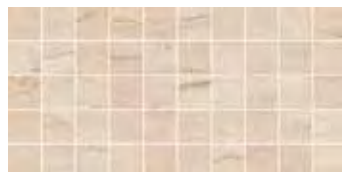

DAINO cream mosaic
22,2 X 44,6
MD001-017



DAINO cream lappato
44,6 x 44,6
MT001-004-1

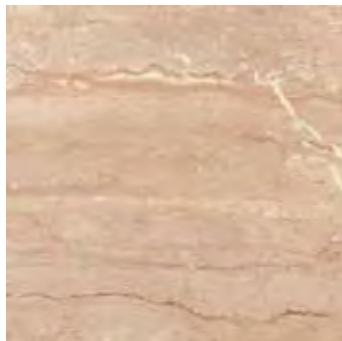

DAINO beige lappato
44,6 x 44,6
MT001-008-1



DAINO beige mosaic
22,2 X 44,6
MD001-018

YAKARA >

GRES
SZKLIWIONY
GLAZED
PORCELAIN
TILES

SMART
SILVER

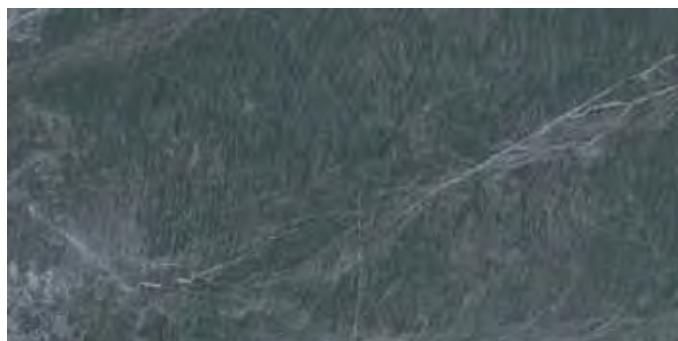

YAKARA graphite
44,6 x 89,5
MT002-009-1

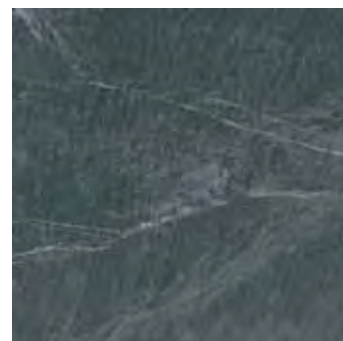

Yakara graphite 44,6 x 44,6
MT002-012-1



YAKARA graphite lappato
44,6 x 89,5
MT002-006-1



YAKARA graphite lappato
44,6 x 44,6
MT002-003-1

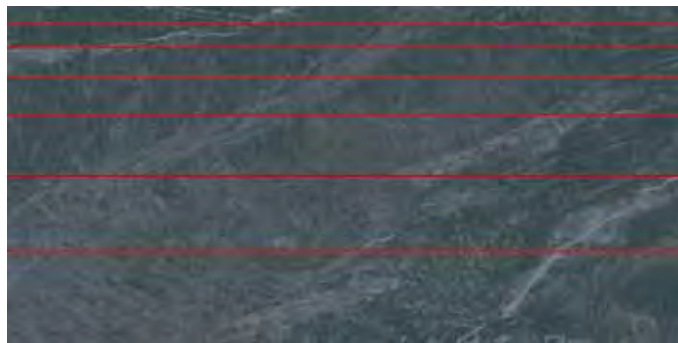

YAKARA graphite inserto line lappato
44,6 x 89,5
MD002-023



YAKARA graphite steel mosaic
22,2 x 44,6
MD002-17



YAKARA graphite mosaic
22,2 x 44,6
MD002-016

YAKARA >

GRES
SZKLIWIONY
GLAZED
PORCELAIN
TILES

SMART
SILVER



YAKARA white
44,6 x 89,5
MT002-007-1



YAKARA white
44,6 x 44,6
MT002-010-1

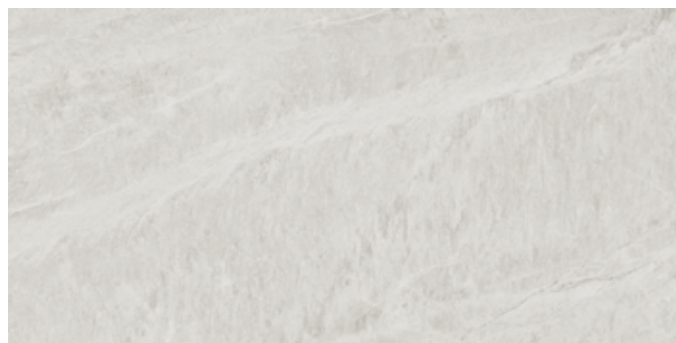

YAKARA white lappato
44,6 x 89,5
MT002-004-1

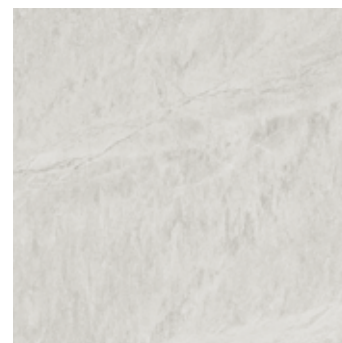

YAKARA white lappato
44,6 x 44,6
MT002-001-1

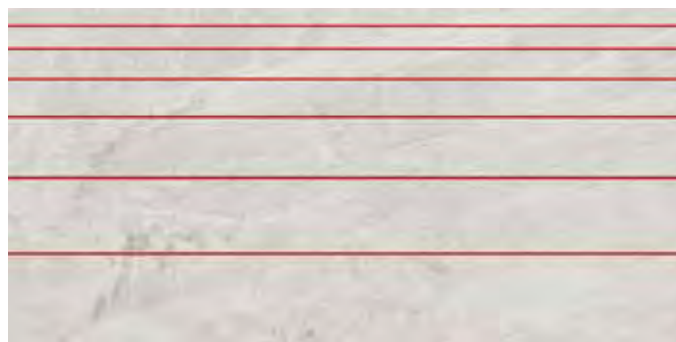

YAKARA white inserto line lappato
44,6 x 89,5
MD002-021



YAKARA white mosaic steel
22,2 x 44,6
MD002-019



YAKARA white mosaic
22,2 x 44,6
MD002-014

PŁYTKI
CERAMICZNE
ŁAZIENKI
PUBLICZNE
CERAMIC
TILES
RESTROOMS

YAKARA >

GRES
SZKLIWIONY
GLAZED
PORCELAIN
TILES

SMART
SILVER



YAKARA grey
44,6 x 89,5
MT002-008-1



YAKARA grey
44,6 x 44,6
MT002-011-1



YAKARA grey lappato
44,6 x 89,5
MT002-005-1



YAKARA grey lappato
44,6 x 44,6
MT002-002-1

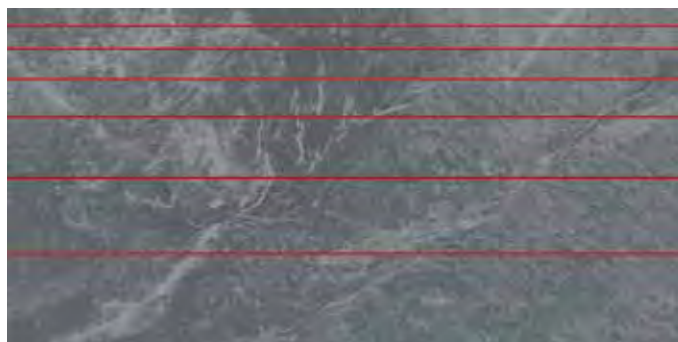

YAKARA grey inserto line lappato
44,6 x 89,5
MD002-022

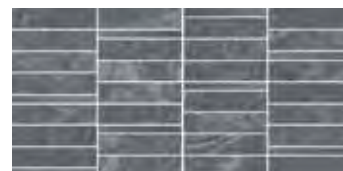

YAKARA grey mosaic steel
22,2 x 44,6
MD002-018



YAKARA grey mosaic
22,2 x 44,6
MD002-015

PLAYA >

GRES
SZKLIWIONY
GLAZED
PORCELAIN
TILES

SMART
SILVER



PLAYA cream lappato
44,6 x 89,5
MT003-001-1



PLAYA cream lappato
44,6 x 44,6
MT003-002-2

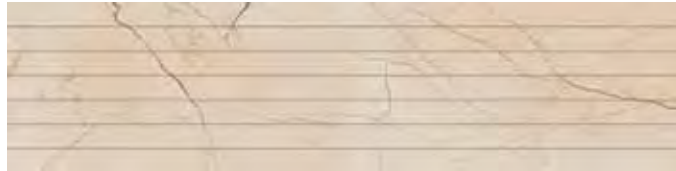

PLAYA cream border line
22,2 x 89,5
MD003-007



PLAYA cream mosaic
22,2 x 44,6
MD003-003



PLAYA cream border line
9,4 x 44,6
MD003-008



PLAYA cream mosaic glass
22,2 x 44,6
MD003-004

SAHARA >

GRES
SZKLIWIONY
GLAZED
PORCELAIN
TILES



SAHARA beige lappato
59,3 x 59,3
OP358-001-1



SAHARA beige lappato
29 x 59,3
OP358-002-1



SAHARA beige border
8,7 x 59,3
OD358-005



SAHARA beige border mosaic
11,7 x 29,5
OD358-004

PRE
STI
GE

SPAZIO >

GRES
 SZKLIWIONY
 GLAZED
 PORCELAIN
 TILES

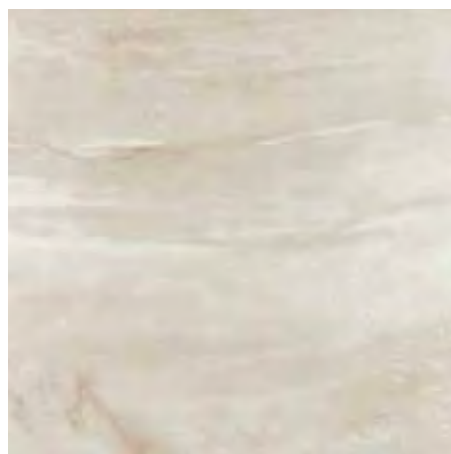

SPAZIO cream
 59,3 x 59,3
 OP054-001-1



SPAZIO cream lappato
 59,3 x 59,3
 OP054-003-1



SPAZIO cream
 29 x 59,3
 OP054-005-1

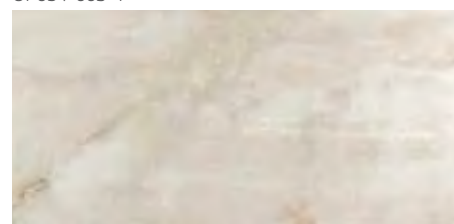

SPAZIO cream lappato
 29 x 59,3
 OP054-007-1



SPAZIO beige
 59,3 x 59,3
 OP054-002-1

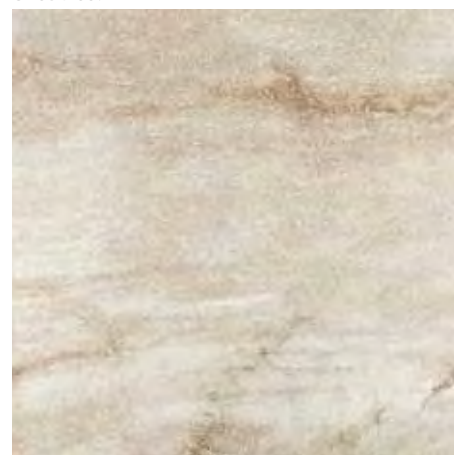

SPAZIO beige lappato
 59,3 x 59,3
 OP054-004-1



SPAZIO beige
 29 x 59,3
 OP054-006-1



SPAZIO beige lappato
 29 x 59,3
 OP054-008-1

◀ LAZIO

GRES SZKLIWIONY (tylko 59,3 x 59,3)
GLAZED PORCELAIN TILES (59,3 x 59,3 only)



LAZIO white
 59,3 x 59,3
 OP004-003-1



LAZIO white polished
 59,3 x 59,3
 OP004-004-1



LAZIO white
 29 x 59,3
 OP004-006-1

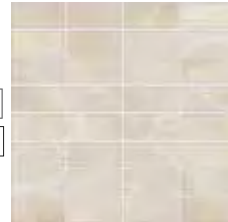

LAZIO white mosaic
 29 x 29,5
 OD004-016



LAZIO white inserto
 29 x 59,3
 OD004-008



LAZIO white border
 9 x 59,3
 OD004-010



LAZIO beige
 59,3 x 59,3
 OP004-001-1



LAZIO beige polished
 59,3 x 59,3
 OP004-002-1



LAZIO beige
 29 x 59,3
 OP004-005-1



LAZIO beige mosaic
 29 x 29,5
 OD004-015



LAZIO beige inserto
 29 x 59,3
 OD004-007



LAZIO beige border
 9 x 59,3
 OD004-011

PRE
 STI
 GE

LAZZARO >

GRES
 SZKLIWIONY
GLAZED
PORCELAIN
TILES



LAZZARO white lappato
 59,3 x 59,3
 OP343-001-1



LAZZARO black lappato
 59,3 x 59,3
 OP343-002-1

VISIONE >

GRES
 SZKLIWIONY
GLAZED
PORCELAIN
TILES



VISIONE cream
 59,3 x 59,3
 OP055-001-1



VISIONE beige
 59,3 x 59,3
 OP055-002-1

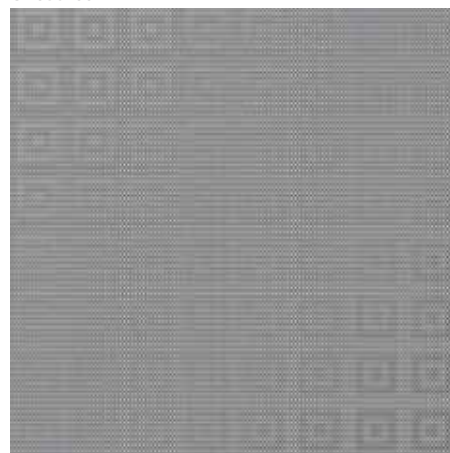

VISIONE grey
 59,3 x 59,3
 OP055-004-1

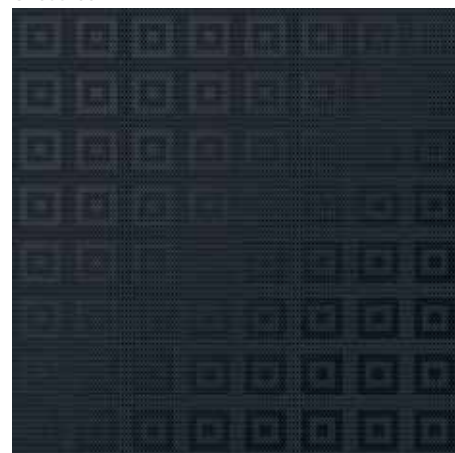

VISIONE black
 59,3 x 59,3
 OP055-005-1

DAMASCO >

GRES
SZKLIWIONY
GLAZED
PORCELAIN
TILES



DAMASCO vanilla
59,8 x 59,8
OP055-001-1



R9

4



DAMASCO vanilla
29,7 x 59,8
OP067-018-1



R9

4



DAMASCO vanilla
29,7 x 29,7
OP067-005-1



R9

4



DAMASCO mocca
59,8 x 59,8
OP055-002-1



R9

3



DAMASCO mocca
29,7 x 59,8
OP067-020-1



R9

3



DAMASCO mocca
29,7 x 29,7
OP067-004-1



R9

3



DAMASCO anthracite
59,8 x 59,8
OP055-004-1



R9

4



DAMASCO anthracite
29,7 x 59,8
OP067-022-1



R9

3



DAMASCO anthracite
29,7 x 29,7
OP067-001-1



R9

3



DAMASCO mix border
7,3 x 34,7
OD067-027



PRE
STI
GE

**PŁYTKI
CERAMICZNE
ŁAZIENKI
PUBLICZNE
CERAMIC
TILES
RESTROOMS**

CARRARA >

GRES
SZKLIWIONY
(tylko 59,3 x 59,3)
**GLAZED
PORCELAIN
TILES**
(59,3 x 59,3 only)

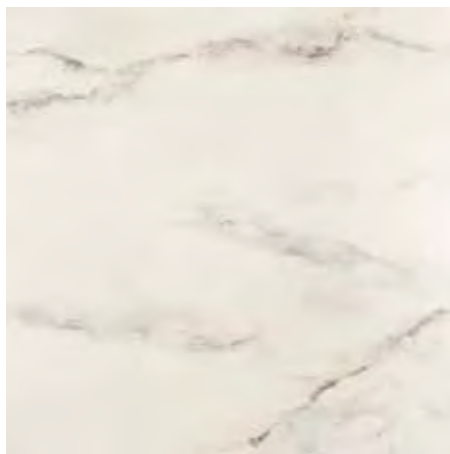

CARRARA
59,3 x 59,3
OP001-001-1



CARRARA polished
59,3 x 59,3
OP001-002-1

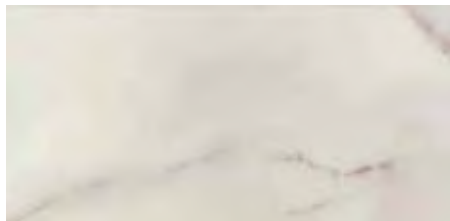

CARRARA
29 x 59,3
OP001-003-1

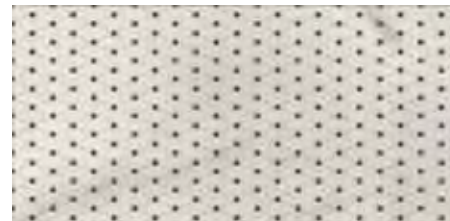

CARRARA inserto classic
29 x 59,3
OD001-004



CARRARA white mosaic
29 x 29,5
OD001-009



CARRARA inserto stripe
29 x 59,3
OD001-005

FARGO >

GRES
SZKLIWIONY
**GLAZED
PORCELAIN
TILES**



FARGO white
59,8x59,8
OP055-001-1



FARGO white
29,7 x 59,8
OP360-008-1

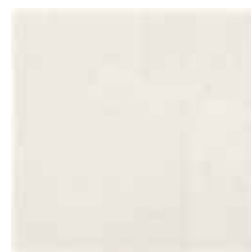

FARGO white
32,6 x 32,6
OP360-012-1

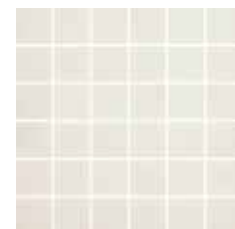

FARGO white mosaic
29,7 x 29,7
OD360-004

FARGO >
 GRES
 SZKLIWIONY
**GLAZED
 PORCELAIN
 TILES**



FARGO grey
 59,8x59,8
 OP055-002-1



FARGO grey
 29,7 x 59,8
 OP360-007-1



FARGO grey
 32,6 x 32,6
 OP360-011-1



FARGO grey mosaic
 29,7 x 29,7
 OD360-003



FARGO brown
 59,8x59,8
 OP055-004-1



FARGO brown
 29,7 x 59,8
 OP360-006-1



FARGO brown
 32,6 x 32,6
 OP360-010-1

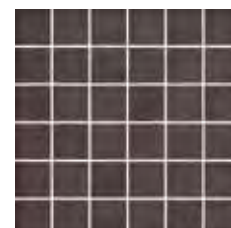

FARGO brown mosaic
 29,7 x 29,7
 OD360-002



FARGO black
 59,8x59,8
 OP055-005-1

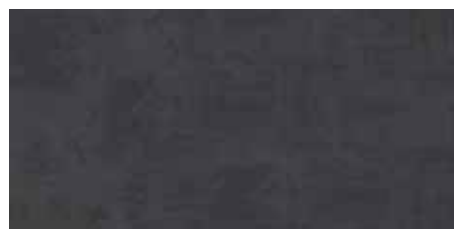

FARGO black
 29,7 x 59,8
 OP360-005-1



FARGO black
 32,6 x 32,6
 OP360-009-1

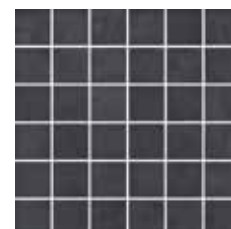

FARGO black mosaic
 29,7 x 29,7
 OD360-001



**PRE
 STI
 GE**

CREAMY TOUCH >

GRES
SZKLIWIONY
(tylko 59,3 x 59,3)
**GLAZED
PORCELAIN
TILES**
(59,3 x 59,3 only)

NOWOŚĆ/NEW



CREAMY TOUCH structure
29 x 59,3
OP635-010-1



CREAMY TOUCH mosaic belt
29 x 59,3
OD635-012

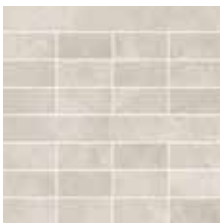

CREAMY TOUCH mosaic
29 x 29,5
OD635-011



CREAMY TOUCH
29 x 59,3
OP635-008-1



CREAMY TOUCH pattern
29 x 59,3
OP635-009 -1



CREAMY TOUCH
59,3 x 59,3
OP635-006-1



R9

4

LIGHT MARBLE >

GRES
SZKLIWIONY
(tylko 59,3 x 59,3)
**GLAZED
PORCELAIN
TILES**
(59,3 x 59,3 only)

NOWOŚĆ/NEW



LIGHT MARBLE beige
59,3 x 59,3
OP636-007-1



LIGHT MARBLE beige mosaic square
29 x 29
OD636-019



LIGHT MARBLE grey
59,3 x 59,3
OP636-008-1



LIGHT MARBLE grey mosaic square
29 x 29
OD636-020



LIGHT MARBLE beige
29 x 59,3
OP636-009-1

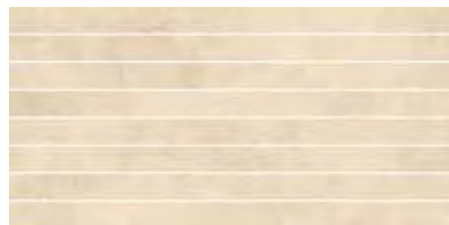

LIGHT MARBLE beige mosaic belt
29 x 59,3
OD636-021



LIGHT MARBLE beige structure
29 x 59,3
OP636-010-1



LIGHT MARBLE grey
29 x 59,3
OP636-011-1



LIGHT MARBLE grey structure
29 x 59,3
OP636-012-1



LIGHT MARBLE grey mosaic belt
29 x 59,3
OD636-022



R10

5



R10

5

EARLY PASTELS >

GRES
 SZKLIWIONY
GLAZED
PORCELAIN
TILES

NOWOŚĆ/NEW



EARLY PASTELS beige
 59,3 x 59,3
 OP647-009-1



EARLY PASTELS beige stripes
 59,3 x 59,3
 OP647-010-1



EARLY PASTELS beige
 29 x 59,3
 OP647-007-1

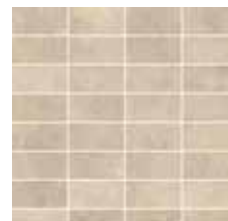

EARLY PASTELS beige mosaic
 29 x 29,5
 OD647-015



EARLY PASTELS grey
 59,3 x 59,3
 OP647-011-1



EARLY PASTELS grey stripes
 59,3 x 59,3
 OP647-012-1



EARLY PASTELS grey
 29 x 59,3
 OP647-008-1

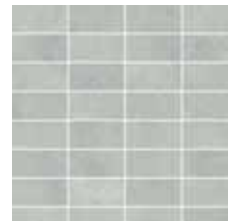

EARLY PASTELS grey mosaic
 29 x 29,5
 OD647-016

AVANGARDE >

GRES
SZKLIWIONY
GLAZED
PORCELAIN
TILES



AVANGARDE white
29,7 x 60
OP352-003-1

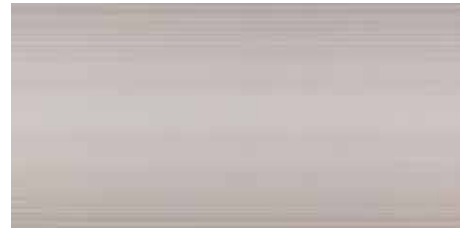

AVANGARDE grey
29,7 x 60
OP352-006-1

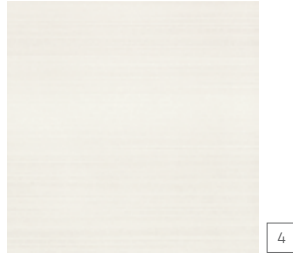

AVANGARDE white
33,3 x 33,3
OP352-008-1

4



AVANGARDE graphite
29,7 x 60
OP352-005-1

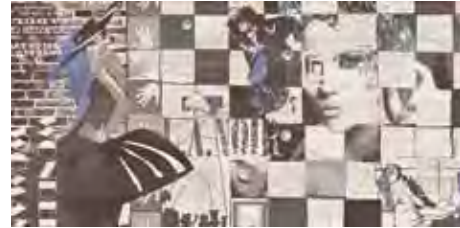

AVANGARDE inserto modern
29,7 x 60
OD352-002

KAROO >

GRES
SZKLIWIONY
GLAZED
PORCELAIN
TILES



KAROO cream
29,7 x 59,8
OP193-002-1

❄️
R10
5



KAROO cream mosaic
29,7 x 29,7
OD193-007

❄️
5



KAROO cream glass mosaic
14,7 x 29,7
OD193-004



KAROO beige
29,7 x 59,8
OP193-001-1

❄️
R10
5



KAROO beige mosaic
29,7 x 29,7
OD193-008

❄️
5



KAROO beige glass mosaic
14,7 x 29,7
OD193-005



KAROO grey
29,7 x 59,8
OP193-003-1

❄️
R10
4



KAROO grey mosaic
29,7 x 29,7
OD193-009

❄️
4



KAROO grey glass mosaic
14,7 x 29,7
OD193-006



KAROO graphite
29,7 x 59,8
OP193-010-1

❄️
R10
4

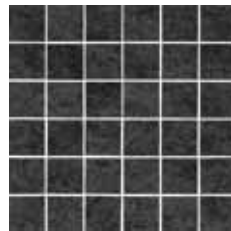

KAROO graphite mosaic
29,7 x 29,7
OD193-012

❄️
4



KAROO graphite glass mosaic
14,7 x 29,7
OD193-011

**PRE
STIGE**

METALIC >

GRES
 SZKLIWIONY
 GLAZED
 PORCELAIN
 TILES



METALIC white
 29,7 x 59,8
 OP011-004-1



METALIC white
 29,7 x 29,7
 OP011-003-1

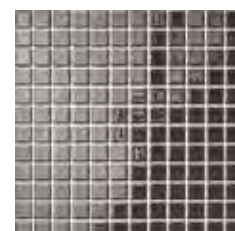

PALETTE graphite glossy mosaic
 30 x 30
 OP041-007-1



METALIC graphite
 29,7 x 59,8
 OP011-009-1



METALIC graphite
 29,7 x 29,7
 OP011-008-1

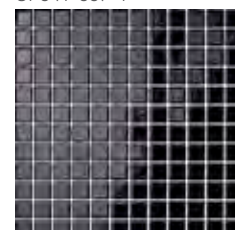

PALETTE black glossy mosaic
 30 x 30
 OP041-005-1



METALIC graphite silver
 29,7 x 59,8
 OP011-010-1

AMARANTE >

GRES
SZKLIWIONY
GLAZED
PORCELAIN
TILES



AMARANTE cream
29,7 x 59,8
OP009-005-1



AMARANTE cream structure
29,7 x 59,8
OP009-006-1



AMARANTE brown
29,7 x 59,8
OP009-001-1

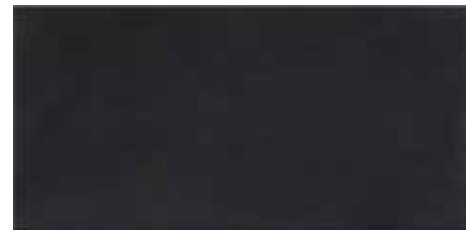

AMARANTE graphite
29,7 x 59,8
OP009-003-1



AMARANTE brown structure
29,7 x 59,8
OP009-002-1



AMARANTE graphite structure
29,7 x 59,8
OP009-004-1



AMARANTE brown inserto modern
29,7 x 59,8
OD009-007



AMARANTE graphite inserto modern
29,7 x 59,8
OD009-008

PENNE >



PENNE white
20 x 50
OP018-002-1

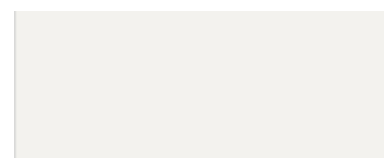

WHITE glossy
20 x 50
OP018-001-1

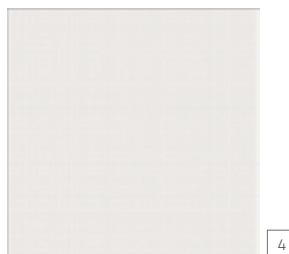

PENNE white
33,3 x 33,3
OP018-003-1

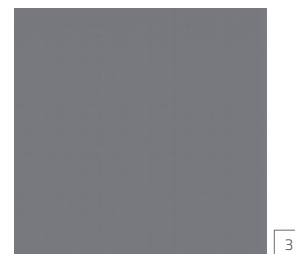

PENNE grey
33,3 x 33,3
OP018-004-1

ORISA >

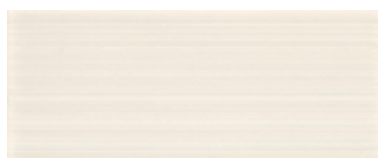

ORISA white
20 x 50
OP342-001-1



ORISA white
33,3 x 33,3
OP342-004-1



ORISA brown
20 x 50
OP342-002-1



ORISA graphite
33,3 x 33,3
OP342-005-1

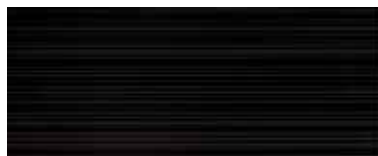

ORISA graphite
20 x 50
OP342-003-1



ORISA inserto modern
20 x 50
OD342-008

PALETTE >

GRES
SZKLIWIONY
GLAZED
PORCELAIN
TILES



PALETTE white mat mosaic
30 x 30
OP041-019-1

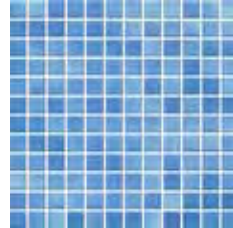

PALETTE blue mat mix mosaic
30 x 30
OP041-018-1

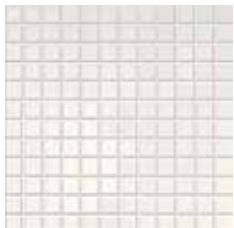

PALETTE white glossy mosaic
30 x 30
OP041-002-1

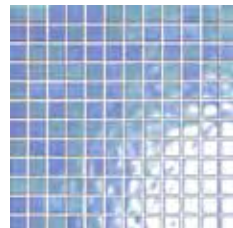

PALETTE blue mix glossy mosaic
30 x 30
OP041-015-1

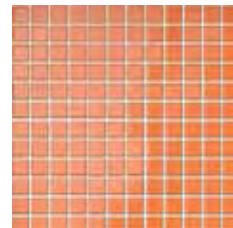

PALETTE orange glossy mosaic
30 x 30
OP041-009-1

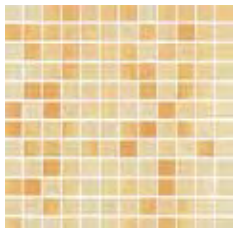

PALETTE beige mat mix mosaic
30 x 30
OP041-016-1

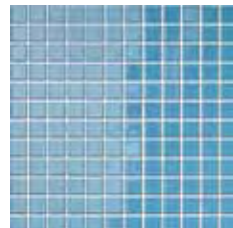

PALETTE blue glossy mosaic
30 x 30
OP041-008-1

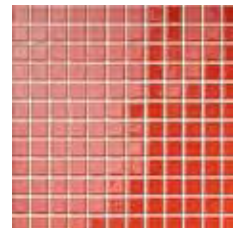

PALETTE red glossy mosaic
30 x 30
OP041-006-1

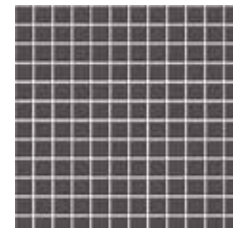

PALETTE grey mat mosaic
30 x 30
OP041-020-1

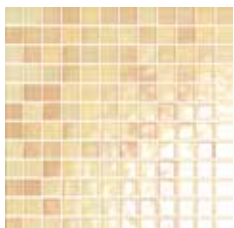

PALETTE beige mix glossy mosaic
30 x 30
OP041-013-1

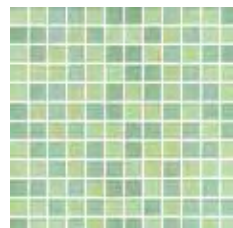

PALETTE green mat mix mosaic
30 x 30
OP041-017-1

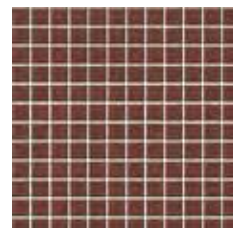

PALETTE brown mat mosaic
30 x 30
OP041-022-1

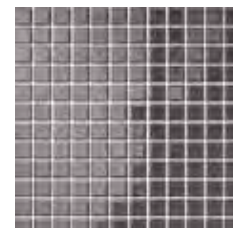

PALETTE grey glossy mosaic
30 x 30
OP041-010-1

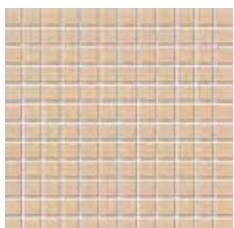

PALETTE beige mat mosaic
30 x 30
OP041-021-1



PALETTE green mix glossy mosaic
30 x 30
OP041-014-1

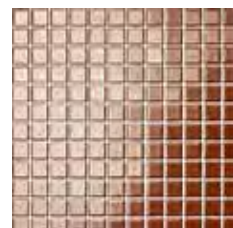

PALETTE brown-gold glossy mosaic
30 x 30
OP041-004-1

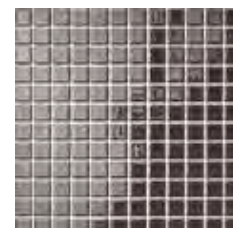

PALETTE graphite glossy mosaic
30 x 30
OP041-007-1

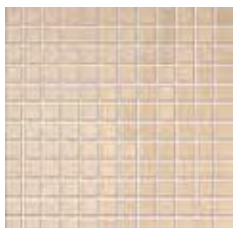

PALETTE beige glossy mosaic
30 x 30
OP041-001-1

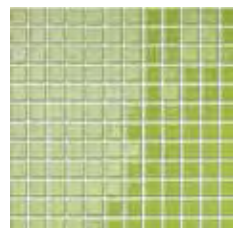

PALETTE green glossy mosaic
30 x 30
OP041-011-1

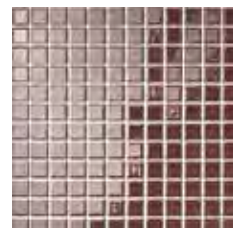

PALETTE brown glossy mosaic
30 x 30
OP041-003-1

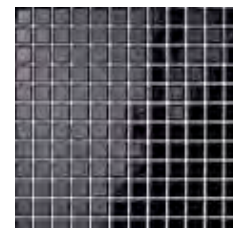

PALETTE black glossy mosaic
30 x 30
OP041-005-1



PRE
STI
GE

INWENCJA >



INWENCJA white
20 x 20
OP044-001-1

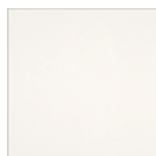

INWENCJA white glossy
20 x 20
OP044-007-1



INWENCJA graphite
20 x 20
OP044-002-1



INWENCJA red
20 x 20
OP044-003-1



INWENCJA white
mosaic
20 x 20
OD044-024



INWENCJA white
mosaic glossy
20 x 20
OD044-025

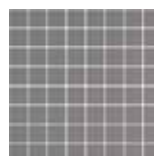

INWENCJA graphite
mosaic
20 x 20
OD044-033

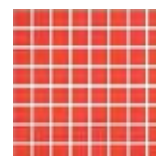

INWENCJA red
mosaic
20 x 20
OD044-034



INWENCJA grey
20 x 20
OP044-014-1

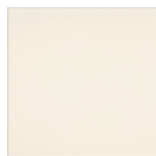

INWENCJA cream
20 x 20
OP044-008-1

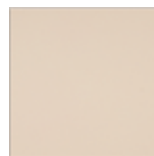

INWENCJA beige
20 x 20
OP044-009-1



INWENCJA mocca
20 x 20
OP044-010-1

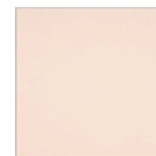

INWENCJA magnolia
20 x 20
OP044-011-1



INWENCJA grey
mosaic
20 x 20
OD044-032

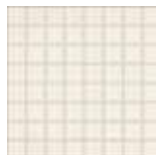

INWENCJA cream
mosaic
20 x 20
OD044-026

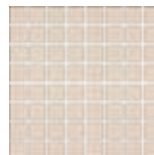

INWENCJA beige
mosaic
20 x 20
OD044-027



INWENCJA mocca
mosaic
20 x 20
OD044-028



INWENCJA
magnolia mosaic
20 x 20
OD044-029

INWENCJA >



INWENCJA yellow
20 x 20
OP044-004-1



INWENCJA sapphire
20 x 20
OP044-006-1



INWENCJA malachite
20 x 20
OP044-005-1



INWENCJA pistachio
20 x 20
OP044-012-1



INWENCJA blue
20 x 20
OP044-013-1

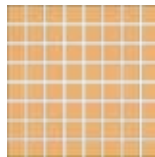

INWENCJA yellow
mosaic
20 x 20
OD044-035

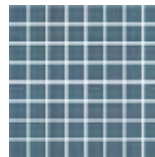

INWENCJA
sapphire mosaic
20 x 20
OD044-037

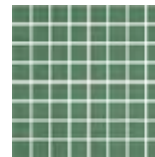

INWENCJA
malachite mosaic
20 x 20
OD044-036

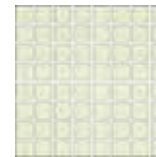

INWENCJA
pistachio mosaic
20 x 20
OD044-030



INWENCJA
blue mosaic
20 x 20
OD044-031



INWENCJA white
10 x 10
OP044-020-1



INWENCJA cream
10 x 10
OP044-022-1



INWENCJA beige
10 x 10
OP044-023-1



INWENCJA graphite
10 x 10
OP044-021-1

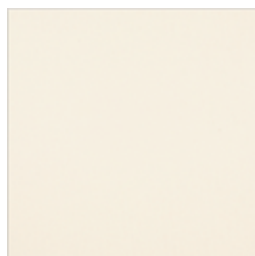

INWENCJA cream
33,3 x 33,3
OP044-016-1

3

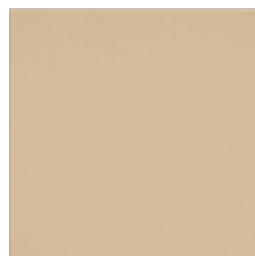

INWENCJA mocca
33,3 x 33,3
OP044-017-1

3



INWENCJA grey
33,3 x 33,3
OP044-019-1

3

PŁYTKI
CERAMICZNE
ŁAZIENKI
PUBLICZNE
CERAMIC
TILES
RESTROOMS

ANCONA >

GRES
SZKLIWIONY
GLAZED
PORCELAIN
TILES



ANCONA beige
29×59,3
W 218-025-1



ANCONA ochre
29×59,3
W 218-028-1



ANCONA beige
14,4×59,3
W 218-013-1



ANCONA ochre
14,4×59,3
W 218-016-1



ANCONA grey
29×59,3
W 218-027-1

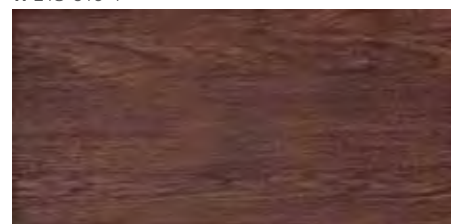

ANCONA brown
29×59,3
W 218-026-1



ANCONA grey
14,4×59,3
W 218-015-1



ANCONA brown
14,4×59,3
W 218-014-1

SYRIO >

GRES
SZKLIWIONY
**GLAZED
PORCELAIN
TILES**



SYRIO white
32,6×32,6
W 262-006-1



SYRIO white
29,7×59,8
W 262-002-1



SYRIO white inserto
29,7×59,8
WD 262-010



SYRIO beige
32,6×32,6
W 262-005-1



SYRIO beige
29,7×59,8
W 262-001-1



SYRIO beige inserto
29,7×59,8
WD 262-011



SYRIO brown
32,6×32,6
W 262-007-1



SYRIO brown
29,7×59,8
W 262-003-1



SYRIO brown inserto
29,7×59,8
WD 262-012

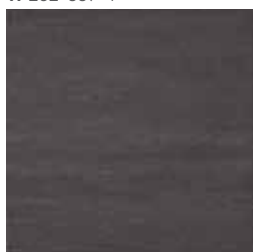

SYRIO black
32,6×32,6
W 262-008-1



SYRIO black
29,7×59,8
W 262-004-1



SYRIO black inserto
29,7×59,8
WD 262-013

**STAN
DARD**

PŁYTKI
CERAMICZNE
ŁAZIENKI
PUBLICZNE
CERAMIC
TILES
RESTROOMS

BIANCA >

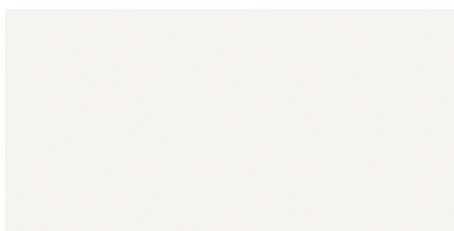

BIANCA matt
29,7 x 60
W 185-002-1

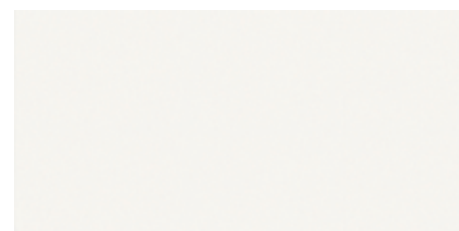

BIANCA
29,7 x 60
W 185-001-1

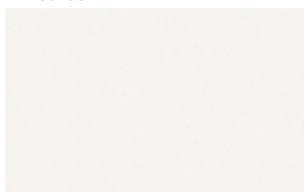

BIANCA matt
25 x 40
W 184-002-1

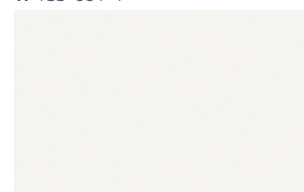

BIANCA
25 x 40
W 184-001-1

IKARIA >



IKARIA white
20x50
W 222-005-1



IKARIA grey
20x50
W 222-006-1



IKARIA circles
20x50
W 222-007-1



IKARIO white
33,3x33,3
W 222-001-1

4

ALBA >

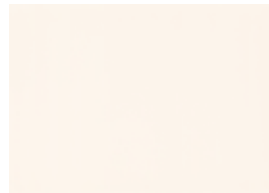

ALBA white
25 x 35
W 239-001-1



ALBA grey
25 x 35
W 239-002-1



ALBA red
25 x 35
W 239-004-1



ALBA inserto modern
25 x 35
WD 239-007

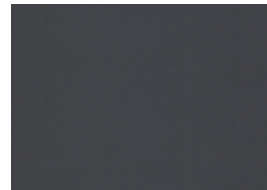

ALBA black
25 x 35
W 239-003-1

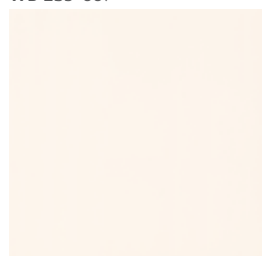

ALBO white
33,3 x 33,3
W 239-005-1

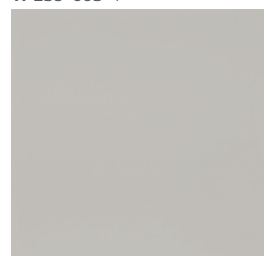

ALBO grey
33,3 x 33,3
W 239-006-1

4

3



PŁYTKI
CERAMICZNE
ŁAZIENKI
HOTELOWE
CERAMIC
TILES
HOTEL
BATHROOMS

N^o3

Łazienki
hotelowe
oraz łazienki
i kuchnie
w budynkach
mieszkalnych
Hotel
bathrooms
as well as
bathrooms
and kitchens
in residential
settings

PŁYTKI
CERAMICZNE
ŁAZIENKI
HOTELOWE
CERAMIC
TILES
HOTEL
BATHROOMS





Ceramika sanitarna: umywalka Caspia oval,
miska zawieszana Deco
Płytki: Black&White
Sanitary ceramics: Caspia oval washbasin,
Deco wall hung bowl
Ceramic tiles: Black&White

BASIC PALETTE >

NOWOŚĆ/NEW



BEIGE GLOSSY
 29,7 x 60
 OP631-035-1

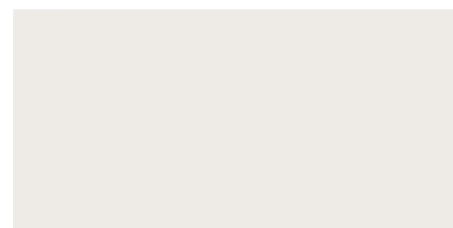

WHITE GLOSSY
 29,7 x 60
 OP631-032-1



BEIGE GLOSSY WAVE
 29,7 x 60
 OP631-034-1



WHITE GLOSSY WAVE
 29,7 x 60
 OP631-031-1



VIOLET SATIN
 29,7 x 60
 OP631-036-1



GRAPHITE SATIN
 29,7 x 60
 OP631-033-1

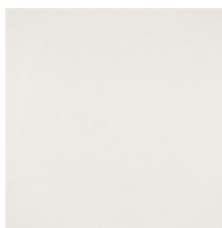

WHITE SEMI-GLOSSY
 29,7 x 29,7
 OP631-037-1



WHITE PATTERN B
 29,7 x 29,7
 OP631-039-1

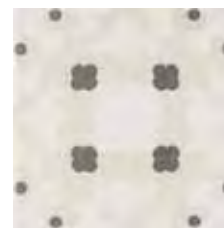

WHITE PATTERN C
 29,7 x 29,7
 OP631-040-1



BASIC PALETTE >

NOWOŚĆ/NEW



BEIGE SATIN
29,7 x 60
OP631-029-1

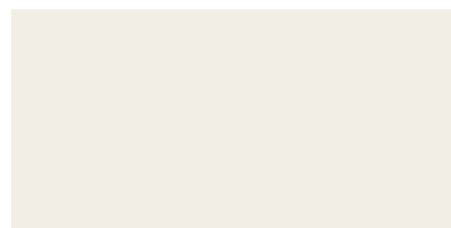

WHITE SATIN
29,7 x 60
OP631-047-1

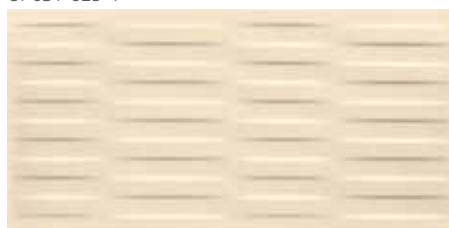

BEIGE SATIN BRAID
29,7 x 60
OP631-028-1

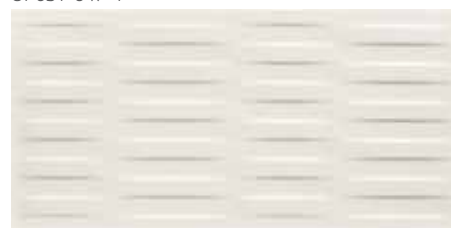

WHITE SATIN BRAID
29,7 x 60
OP631-026-1

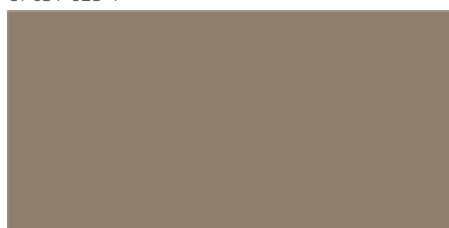

MOCCA SATIN
29,7 x 60
OP631-030-1

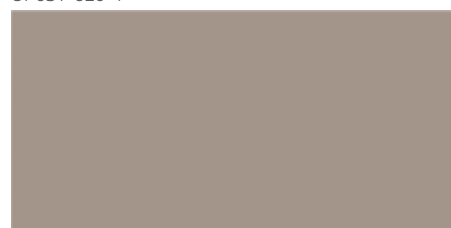

GREY SATIN
29,7 x 60
OP631-027-1



BEIGE SEMI-GLOSSY
29,7 x 29,7
OP631-041-1



BEIGE PATTERN B
29,7 x 29,7
OP631-043-1

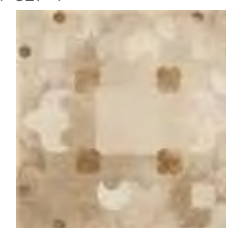

BEIGE PATTERN C
29,7 x 29,7
OP631-044-1



WHITE MAGIC >

NOWOŚĆ / NEW



WHITE glossy squares
25 x 75
OP682-001-1



WHITE glossy pillow
25 x 75
OP684-004-1

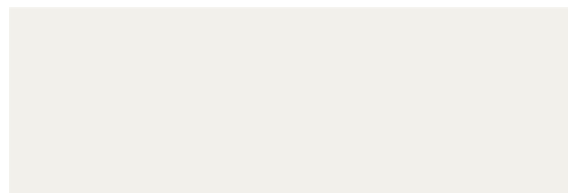

WHITE glossy
25 x 75
OP675-001-1



PLATINUM inserto flower
25 x 75
OD334-011

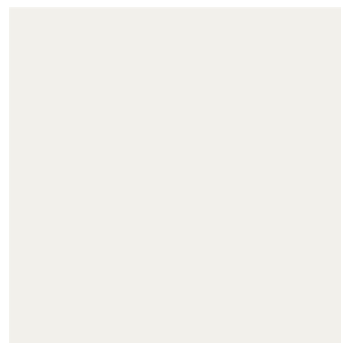

WHITE satin
45 X 45
OP682-002-1



4

VIVID COLOURS >

NOWOŚĆ/NEW

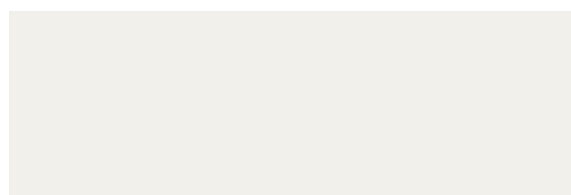

WHITE glossy
25 x 75
OP675-001-1



WHITE glossy pillow
25 x 75
OP684-004-1



MINT glossy
25 x 75
OP685-005-1



MINT glossy pillow
25 x 75
OP685-006-1

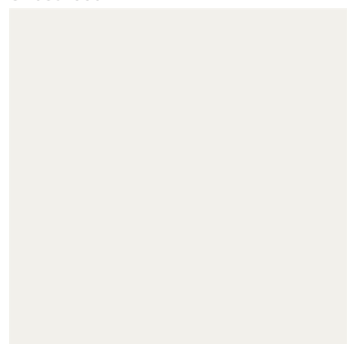

WHITE satin
45 X 45
OP682-002-1



4



BLUE glossy
25 x 75
OP685-001-1



BLUE glossy pillow
25 x 75
OP685-002-1



VIOLET glossy
25 x 75
OP685-007-1



VIOLET glossy pillow
25 x 75
OP685-008-1

PRE
STI
GE

PŁYTKI
CERAMICZNE
ŁAZIENKI
HOTELOWE
CERAMIC
TILES
HOTEL
BATHROOMS

STONE FLOWERS >

NOWOŚĆ/NEW



STONE beige
25 x 75
OP683-001-1



STONE FLOWERS inserto geo
25 x 75
OD683-007



STONE FLOWERS beige border
4 x 75
OD683-009

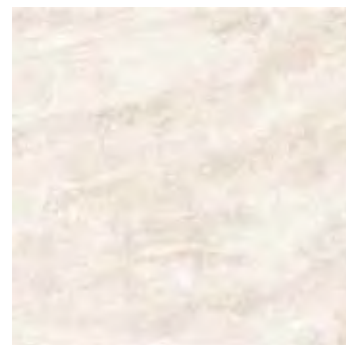

STONE beige
45 x 45
OP683-004-1



4

PRÊT-À-PORTER >

NOWOŚĆ / NEW

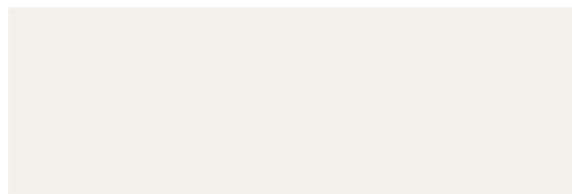

WHITE glossy
25 x 75
OP675-001-1



WHITE glossy pillow
25 x 75
OP684-004-1

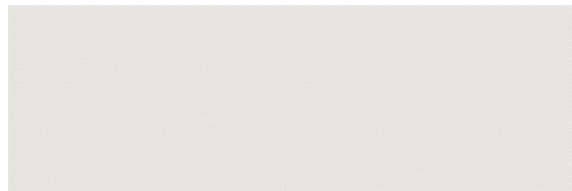

WHITE textile
25 x 75
OP684-005-1



WHITE inserto flower
25 x 75
OD334-012



BLACK & WHITE mosaic
25 x 75
OD334-010



BLACK glossy
25 x 75
OP684-001-1



BLACK glossy pillow
25 x 75
OP684-002-1



BLACK textile
25 x 75
OP684-003-1

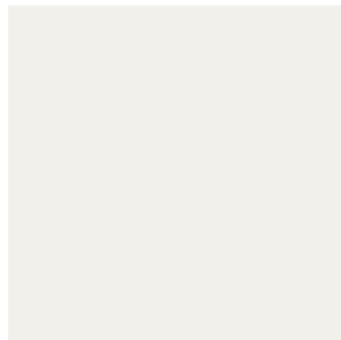

WHITE satin
45 x 45
OP682-002-1

PRE
STI
GE

GEOMETRIC GAME >

NOWOŚĆ / NEW



CLOUD grey glossy
25 x 75
OP680-002-1



CLOUD grey glossy squares
25 x 75
OP680-003-1



GEOMETRIC GAME inserto geo
25 x 75
OD697-001



CLOUD grey satin
45 x 45
OP680-005-1



4

ELEGANT STRIPES >

NOWOŚĆ/NEW



STRIPES white
25 x 75
OP681-005-1



STRIPES white structure
25 x 75
OP681-006-1



STRIPES blue
25 x 75
OP681-001-1



STRIPES blue structure
25 x 75
OP681-002-1



STRIPES violet
25 x 75
OP681-003-1



STRIPES violet structure
25 x 75
OP681-004-1



STRIPES white
45 x 45
OP681-007-1



PRE
STI
GE

**PŁYTKI
CERAMICZNE
ŁAZIENKI
HOTELOWE
CERAMIC
TILES
HOTEL
BATHROOMS**

LIVINGWOOD >

GRES
SZKLIWIONY
GLAZED
PORCELAIN
TILES



LIVINGWOOD maple
29 x 59,3
OP364-001-1



LIVINGWOOD maple
14,4 x 59,3
OP364-004-1



LIVINGWOOD pine
29 x 59,3
OP364-002-1



LIVINGWOOD pine
14,4 x 59,3
OP364-005-1



LIVINGWOOD chestnut
29 x 59,3
OP364-003-1



LIVINGWOOD chestnut
14,4 x 59,3
OP364-006-1

ALLWOOD >

GRES
SZKLIWIONY
GLAZED
PORCELAIN
TILES



ALLWOOD pine
29,7 x 59,8
OP361-005-1



ALLWOOD pine
14,8 x 59,8
OP361-001-1



ALLWOOD oak
29,7 x 59,8
OP361-006-1



ALLWOOD oak
14,8 x 59,8
OP361-002-1



ALLWOOD teak
29,7 x 59,8
OP361-007-1



ALLWOOD teak
14,8 x 59,8
OP361-003-1



ALLWOOD nut
29,7 x 59,8
OP361-008-1



ALLWOOD nut
14,8 x 59,8
OP361-004-1

NATURALE >

GRES
SZKLIWIONY
GLAZED
PORCELAIN
TILES



NATURALE cream
29,7 x 59,8
OP012-009-1



NATURALE orange
29,7 x 59,8
OP012-012-1



NATURALE orange mosaic
29,7 x 29,7
OD012-023



NATURALE cream
14,8 x 59,8
OP012-007-1



NATURALE orange
14,8 x 59,8
OP012-010-1



NATURALE beige
29,7 x 59,8
OP012-003-1



NATURALE brown
29,7 x 59,8
OP012-006-1



NATURALE brown mosaic
29,7 x 29,7
OD012-022



NATURALE beige
14,8 x 59,8
OP012-001-1



NATURALE brown
14,8 x 59,8
OP012-004-1



NATURALE silver border classic
14,8 x 59,8
OD012-020



NATURALE gold border classic
14,8 x 59,8
OD012-018



NATURALE cream
29,7 x 29,7
OP012-008-1



NATURALE beige
29,7 x 29,7
OP012-002-1



NATURALE orange
29,7 x 29,7
OP012-011-1



NATURALE brown
29,7 x 29,7
OP012-005-1

PRE
STI
GE

BLACK&WHITE >



BLACK&WHITE pattern A
 20 x 50
 OP399-003-1



BLACK&WHITE pattern C
 20 x 50
 OP399-005-1



BLACK&WHITE pattern E
 20 x 50
 OP399-009-1

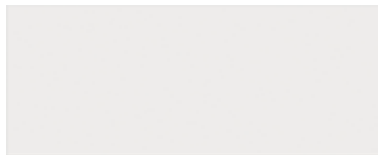

WHITE satin
 20 x 50
 OP399-001-1

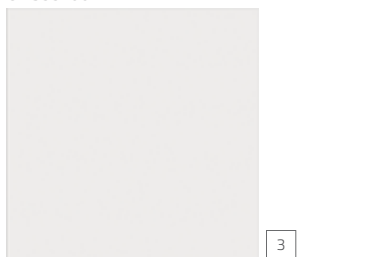

WHITE satin
 33,3 x 33,3
 OP399-007-1

3



BLACK&WHITE pattern B
 20 x 50
 OP399-004-1

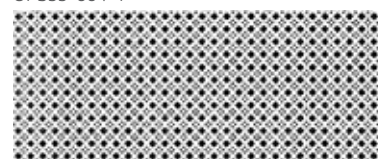

BLACK&WHITE pattern D
 20 x 50
 OP399-006-1

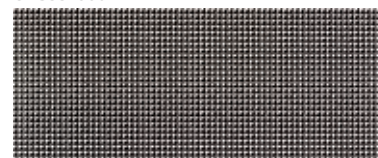

BLACK&WHITE pattern F
 20 x 50
 OP399-010-1



BLACK satin
 20 x 50
 OP399-002-1



BLACK satin
 33,3 x 33,3
 OP399-008-1

2

CAPRI >



CAPRI cream
20 x 50
OP015-007-1



CAPRI cream mosaic
20 x 50
OD015-025



CAPRI cream
29,7 x 29,7
OP015-003-1



CAPRI orange
20 x 50
OP015-008-1

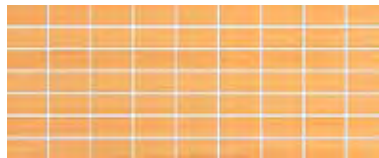

CAPRI orange mosaic
20 x 50
OD015-026



CAPRI orange
29,7 x 29,7
OP015-004-1



CAPRI violet
20 x 50
OP015-006-1



CAPRI violet mosaic
20 x 50
OD015-024



CAPRI violet
29,7 x 29,7
OP015-002-1

FUSION >



FUSION red
 20 x 50
 OP016-003-1

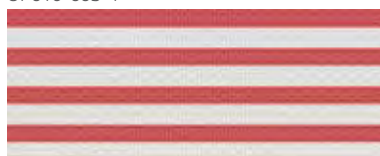

FUSION red mosaic
 20 x 50
 OD016-018



FUSION red inserto
 20 x 50
 OD016-011

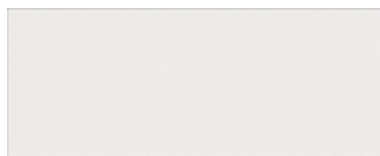

FUSION white
 20 x 50
 OP016-001-1



FUSION white inserto
 20 x 50
 OD016-009

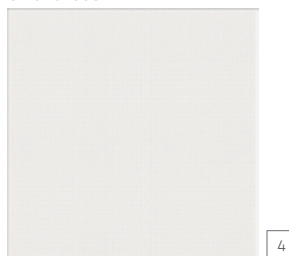

FUSION white
 33,3 x 33,3
 OP016-005-1



FUSION graphite
 20 x 50
 OP016-004-1

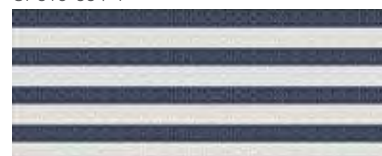

FUSION graphite mosaic
 20 x 50
 OD016-019



FUSION graphite inserto
 20 x 50
 OD016-012



FUSION brown
 20 x 50
 OP016-002-1

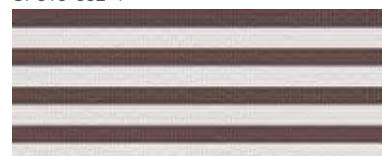

FUSION brown mosaic
 20 x 50
 OD016-017



FUSION brown inserto
 20 x 50
 OD016-010

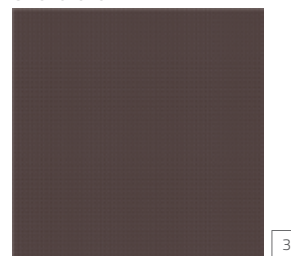

FUSION brown
 33,3 x 33,3
 OP016-006-1

ORGANZA >



ORGANZA white
20 x 50
OP017-007-1



ORGANZA white mosaic
20 x 50
OD017-022



ORGANZA white
29,7 x 29,7
OP017-002-1



3



ORGANZA cream
20 x 50
OP017-009-1



ORGANZA cream mosaic
20 x 50
OD017-024



ORGANZA cream
29,7 x 29,7
OP017-004-1



3



ORGANZA grey
20 x 50
OP017-011-1

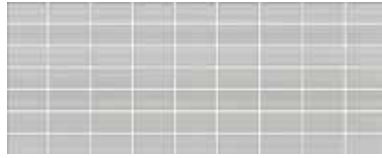

ORGANZA grey mosaic
20 x 50
OD017-027



ORGANZA grey
29,7 x 29,7
OP017-005-1



2



ORGANZA brown
20 x 50
OP017-008-1

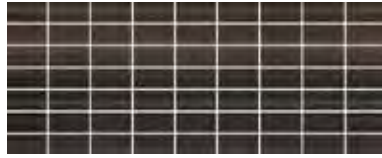

ORGANZA brown mosaic
20 x 50
OD017-023

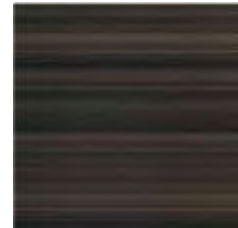

ORGANZA brown
29,7 x 29,7
OP017-003-1



2



ORGANZA mosaic mix B
20 x 50
OD017-026



ORGANZA mosaic mix A
20 x 50
OD017-025

SALONIKA >

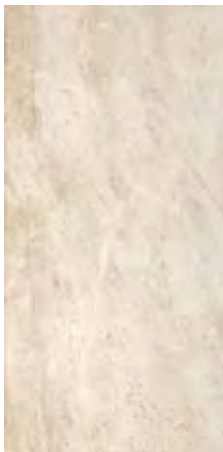

SALONIKA cream
29 x 59,3
OP006-003-1

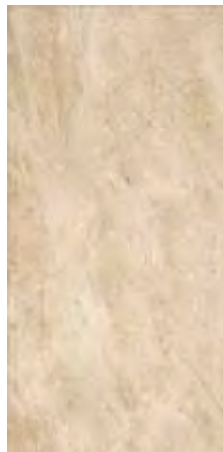

SALONIKA beige
29 x 59,3
OP006-002-1



SALONIKA cream inserto
29 x 59,3
OD006-004



SALONIKA beige
29 x 29
OP006-001-1



3

**PRE
STI
GE**

PŁYTKI
CERAMICZNE
ŁAZIENKI
HOTELOWE
CERAMIC
TILES
HOTEL
BATHROOMS

FIJI >



FIJI cream
 30 x 45
 OP023-003-1



FIJI brown
 30 x 45
 OP023-002-1

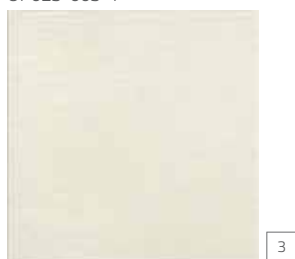

FIJI cream
 33,3 x 33,3
 OP023-006-1

3

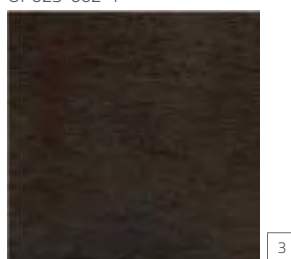

FIJI brown
 33,3 x 33,3
 OP023-005-1

3

ZEBRANO >



ZEBRANO cream
 30 x 45
 OP028-002-1



ZEBRANO cream mosaic
 30 x 45
 OD028-019

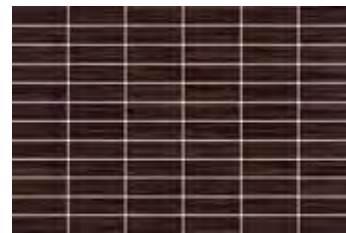

ZEBRANO brown mosaic
 30 x 45
 OD028-018



ZEBRANO brown
 30 x 45
 OP028-001-1

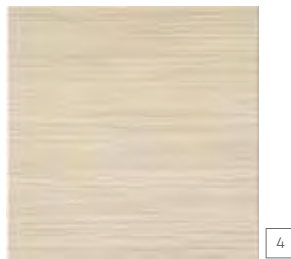

ZEBRA cream
 33,3 x 33,3
 OP028-004-1

4



ZEBRA brown
 33,3 x 33,3
 OP028-003-1

2

BARICELLO >

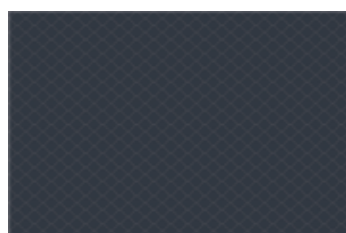

BARICELLO graphite
30 x 45
OP021-004-1



BARICELLO graphite inserto classic
30 x 45
OD021-014



BARICELLO graphite border classic
7 x 45
OD021-019

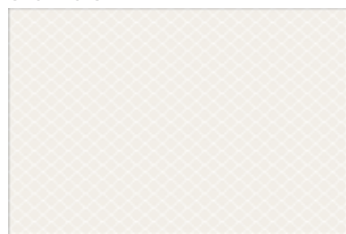

BARICELLO white
30 x 45
OP021-001-1

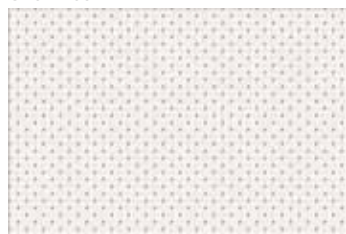

BARICELLO white inserto classic
30 x 45
OD021-009



BARICELLO white border classic
7 x 45
OD021-016

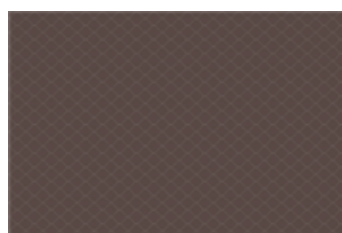

BARICELLO brown
30 x 45
OP021-002-1



BARICELLO brown inserto classic
30 x 45
OD021-010



BARICELLO brown border classic
7 x 45
OD021-017

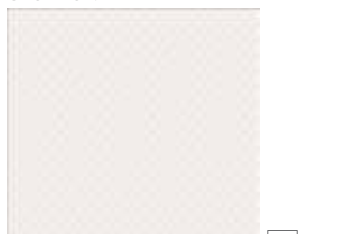

BARICELLO white
33,3 x 33,3
OP021-005-1

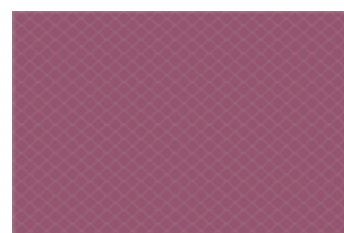

BARICELLO violet
30 x 45
OP021-003-1



BARICELLO violet inserto classic
30 x 45
OD021-012



BARICELLO violet border classic
7 x 45
OD021-018

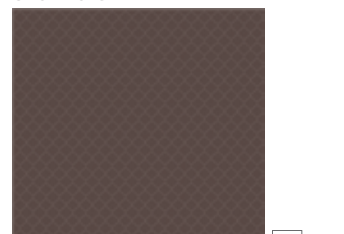

BARICELLO brown
33,3 x 33,3
OP021-006-1

**PRE
STI
GE**

**PŁYTKI
CERAMICZNE
ŁAZIENKI
HOTELOWE
CERAMIC
TILES
HOTEL
BATHROOMS**

MODENA >



MODENA blue
29,7x60
W 242-003-1

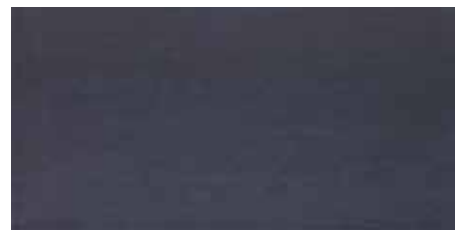

MODENA black
29,7x60
W 242-004-1



MODENA white
29,7x60
W 242-001-1



MODENA grey
29,7x60
W 242-002-1

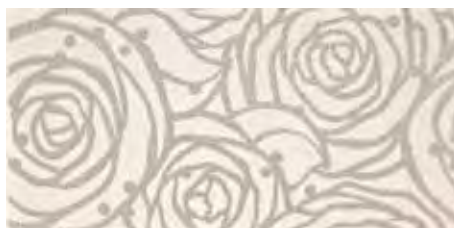

MODENA white inserto rose
29,7x60
WD 242-015



MODENA grey inserto rose
29,7x60
WD 242-016



MODENA white border rose
7,5x60
WD 242-017



MODENA grey border rose
7,5x60
WD 242-018



4

MODENO white
33,3 x33,3
W 242-013-1



4

MODENO grey
33,3 x33,3
W 242-014-1

STEEL >



R10

4

STEEL white
29,7x59,8
W 237-004-1



R10

3

STEEL black
29,7x59,8
W 237-006-1



STEEL mosaic mix
29,7x29,7
WD 237-014

STEEL >



STEEL white
45 x 45
W 237-001-1



STEEL black
45 x 45
W 237-003-1



SYNTHIA >



SYNTHIA violet
20x50
W 206-006-1



SYNTHIA orange
20x50
W 206-004-1



SYNTHIO violet
33,3x33,3
W 206-032-1

3

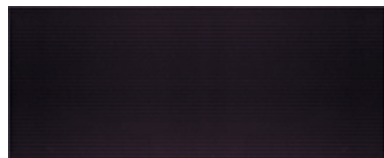

SYNTHIA black
20x50
W 206-003-1



SYNTHIA green
20x50
W 206-005-1



SYNTHIO orange
33,3x33,3
W 206-030-1

4

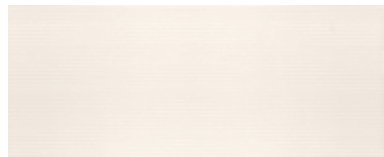

SYNTHIA white
20x50
W 206-001-1



SYNTHIA grey
20x50
W 206-002-1



SYNTHIO green
33,3x33,3
W 206-031-1

3



SYNTHIA violet inserto circles
20x50
WD 206-017



SYNTHIA orange inserto circles
20x50
WD 206-015



SYNTHIO grey
33,3x33,3
W 206-029-1

2



SYNTHIA black inserto circles
20x50
WD 206-014



SYNTHIA green inserto circles
20x50
WD 206-016

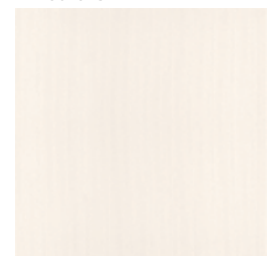

SYNTHIO white
33,3x33,3
W 206-038-1

4

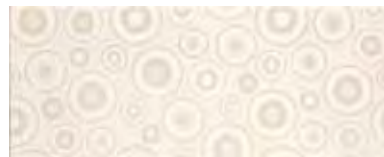

SYNTHIA white inserto circles
20x50
WD 206-012



SYNTHIA grey inserto circles
20x50
WD 206-013

STAN
ARD

**PŁYTKI
CERAMICZNE
ŁAZIENKI
HOTELOWE
CERAMIC
TILES
HOTEL
BATHROOMS**

ATOLA >



ATOLA white
30 x 45
W 225-002-1



ATOLA orange
30 x 45
W 225-004-1



ATOLA blue
30 x 45
W 225-001-1



ATOLA white inserto circles orange
30 x 45
WD 212-019



ATOLA orange inserto circles
30 x 45
WD 212-016



ATOLA blue inserto circles
30 x 45
WD 212-015



ATOLA white inserto circles blue
30 x 45
WD 212-018



ATOLA orange inserto beads A
30 x 45
WD 212-011



ATOLA blue inserto beads A
30 x 45
WD 212-009



ATOLA orange inserto beads B
30 x 45
WD 212-012



ATOLA blue inserto beads B
30 x 45
WD 212-010



ATOLI white
33,3 x 33,3
W 212-005-1

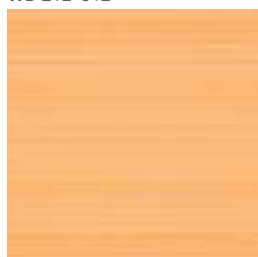

ATOLI orange
33,3 x 33,3
W 212-007-1

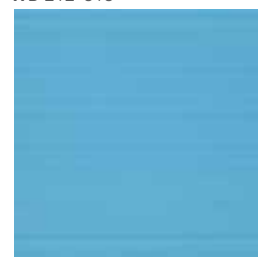

ATOLI blue
33,3 x 33,3
W 212-006-1

ARANCIA >

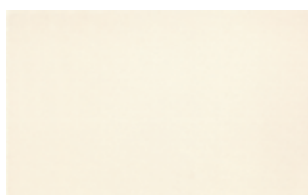

ARANCIA cream
25 x 40
W 299-001-1

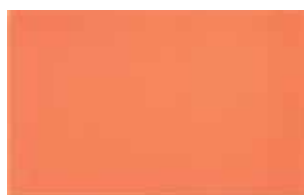

ARANCIA orange
25 x 40
W 299-002-1



ARANCIA cream inserto geometric
25 x 40
WD 299-007

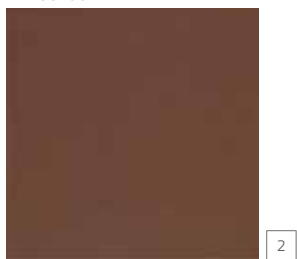

ARANCIA brown
33,3 x 33,3
W 299-005-1

DIANTUS >



DIANTUS orange
25 x 40
W 297-004-1



DIANTUS burgundy
25 x 40
W 297-002-1



DIANTUS yellow
25 x 40
W 297-003-1



DIANTUS orange inserto stripe
25 x 40
WD 297-009



DIANTUS burgundy inserto stripe
25 x 40
WD 297-008



DIANTUS yellow inserto stripe
25 x 40
WD 297-010



DIANTUS white
25 x 40
W 297-001-1

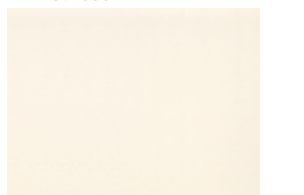

DIANTUS white
33,3 x 33,3
W 297-014-1

**STAN
DARD**

LAVANDE >

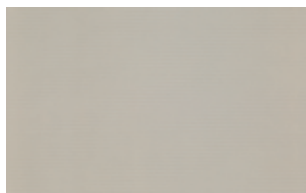

LAVANDE grey
25 x 40
W 296-004-1



LAVANDE brown
25 x 40
W 296-003-1

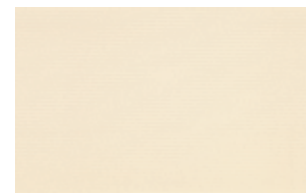

LAVANDE cream
25 x 40
W 296-002-1

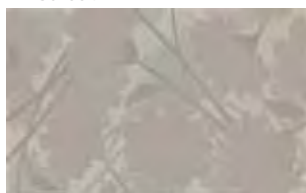

LAVANDE grey inserto flower
25 x 40
WD 296-008



LAVANDE brown inserto flower
25 x 40
WD 296-007

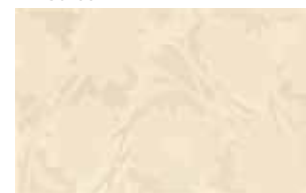

LAVANDE cream inserto flower
25 x 40
WD 296-006

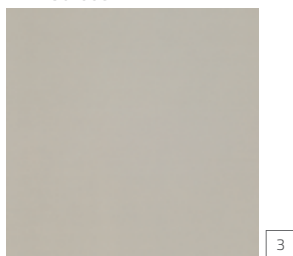

LAVANDE grey
33,3 x 33,3
W 296-013-1

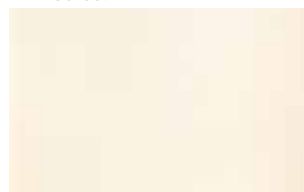

LAVANDE white
25 x 40
W 296-001-1

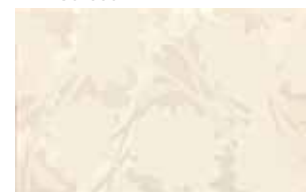

LAVANDE white inserto flower
25 x 40
WD 296-005

ARVENA >

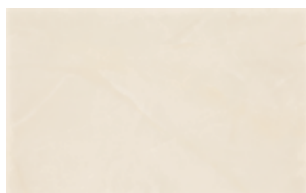

ARVENA white
25x40
W 220-005-1

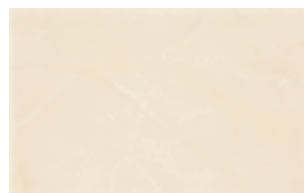

ARVENA beige
25x40
W 220-004-1



ARVENA white inserto
25x40
WD 220-013



ARVENA beige inserto
25x40
WD 220-012

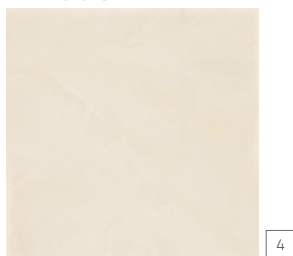

ARVENA white
33,3x33,3
W 220-007-1

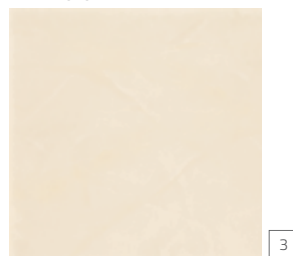

ARVENA beige
33,3x33,3
W 220-006-1

SELENE >

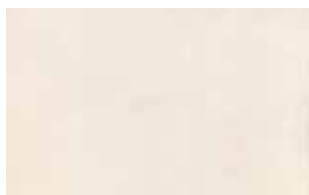

SELENE white
25x40
W 617-001-1



SELENE white inserto flower
25x40
Wd 617-004



SELENE white
33,3x33,3
W 617-010-1

3



SELENE rose
25x40
W 617-003-1



SELENE rose inserto flower
25x40
WD 617-006



SELENE rose
33,3x33,3
W 617-011-1

3



SELENE grey
25x40
W 617-002-1



SELENE grey inserto flower
25x40
WD 617-005

STAN
DARD

ARTIGA >



ARTIGA yellow
25x35
OP 032-008-1



ARTIGA green
25x35
OP 032-007-1



ARTIGA violet
25x35
OP 032-003-1



ARTIGA yellow mosaic
25x35
OD 032-028



ARTIGA green mosaic
25x35
OD 032-027



ARTIGA violet mosaic
25x35
OD 032-025



ARTIGA lemon
25x35
OP 032-002-1



ARTIGA light green
25x35
OP 032-006-1



ARTIGA lavender
25x35
OP 032-004-1



ARTIGA yellow
33,3x33,3
OP 032-012-1

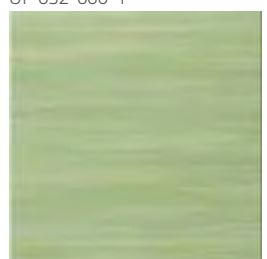

ARTIGA green
33,3x33,3
OP 032-011-1



ARTIGA violet
33,3x33,3
OP 032-009-1

FLORES >



FLORES cream
25x35
OP 036-002-1



FLORES brown
25x35
OP 036-001-1

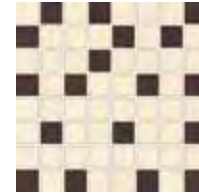

FLORES mosaic mix
25x25
OD 036-018



FLORES cream
33,3x33,3
OP 036-004-1

3



FLORES brown
33,3x33,3
OP 036-003-1

2

OPTICA >



OPTICA brown
25x35
W 240-002-1



OPTICA green
25x35
W 240-004-1



OPTICA red
25x35
W 240-003-1



OPTICA brown inserto modern
25x35
WD 240-015

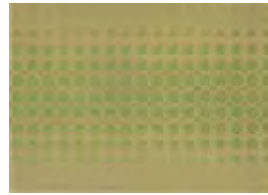

OPTICA green inserto modern
25x35
WD 240-017

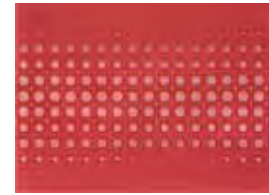

OPTICA red inserto modern
25x35
WD 240-016

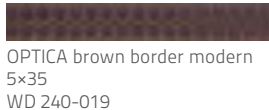

OPTICA brown border modern
5x35
WD 240-019



OPTICA green border modern
5x35
WD 240-021

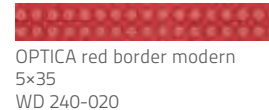

OPTICA red border modern
5x35
WD 240-020

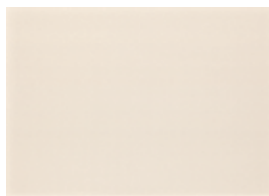

OPTICA white
25x35
W 240-001-1



OPTICA white inserto modern
25x35
WD 240-014

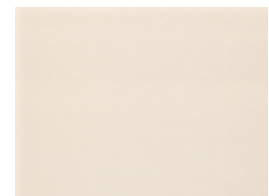

OPTICO white
33,3x33,3
W 240-005-1

4



OPTICA white border modern
5x35
WD 240-018

TRAWERTINO >



TRAWERTINO beige
25x35
W 052-001-1



TRAWERTINO brown
25x35
W 052-002-1



TRAWERTINO beige
inserto storie
25x35
WD 052-020



TRAWERTYN brown
33,3x33,3
W 052-005-1

4

STAN
DARD

**PŁYTKI
CERAMICZNE
ŁAZIENKI
HOTELOWE
CERAMIC
TILES
HOTEL
BATHROOMS**

BRISTO >

GRES
SZKLIWIONY
**GLAZED
PORCELAIN
TILES**



BRISTO grey
45 x 45
W311-001-1

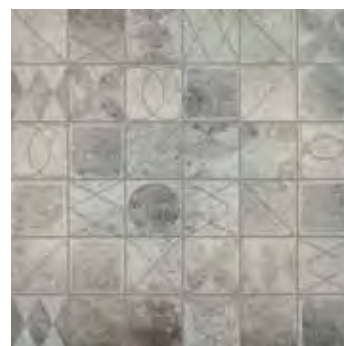

BRISTO grey mosaic
45 x 45
W311-002-1

BROSTO >

GRES
SZKLIWIONY
**GLAZED
PORCELAIN
TILES**

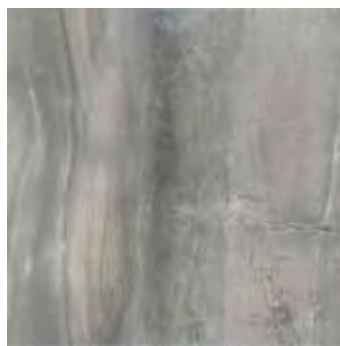

BROSTO graphite
45 x 45
W310-002-1

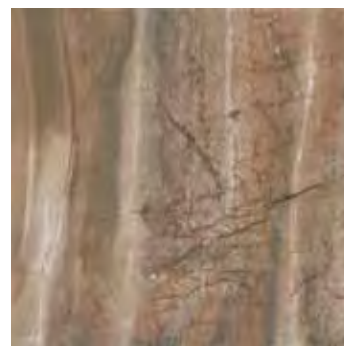

BROSTO brown
45 x 45
W310-001-1

CALSTO >

GRES
SZKLIWIONY
**GLAZED
PORCELAIN
TILES**



CALSTO beige
45 x 45
W309-001-1



CALSTO grey
45 x 45
W309-002-1

GUSTO >
GRES
SZKLIWIONY
**GLAZED
PORCELAIN
TILES**

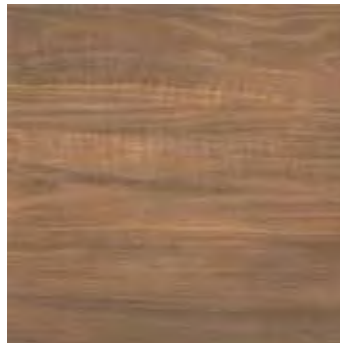

GUSTO brown
45 x 45
W312-001-1



3



GUSTO brown decor
45 x 45
W312-002-1



3

MISTO >
GRES
SZKLIWIONY
**GLAZED
PORCELAIN
TILES**



MISTO cream
45 x 45
W313-001-1



3



MISTO cream decor
45 x 45
W313-002-1



3

NUTTO >
GRES
SZKLIWIONY
**GLAZED
PORCELAIN
TILES**



NUTTO cream
45 x 45
W314-001-1



4



NUTTO cream decor
45 x 45
W314-002-1



3

**STAN
DARD**



PŁYTKI
CERAMICZNE
ELEWACJE
TARASY
CERAMIC
TILES
BUILDING FAÇADES
AND TERRACES

N^o4

Elewacje
Tarasy
Schody
Building
façades
Terraces
Stairs

PŁYTKI
CERAMICZNE
ELEWACJE
TARASY
CERAMIC
TILES
BUILDING FAÇADES
AND TERRACÉS





Płytki: Quartz beige
Ceramic tiles: Quartz beige

**PŁYTKI
CERAMICZNE
ELEWACJE
TARASY
CERAMIC
TILES
BUILDING FAÇADES
AND TERRACÉS**

QUARTZ >

GRES
SZKLIWIONY
**GLAZED
PORCELAIN
TILES**

**SMART
SILVER**

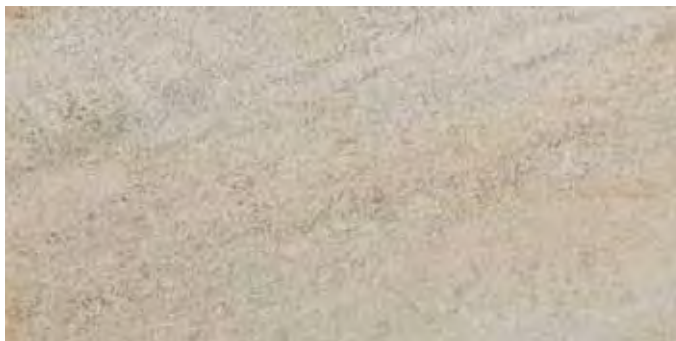

QUARTZ beige
44,6 x 89,5
MT006-001-1



R9

4

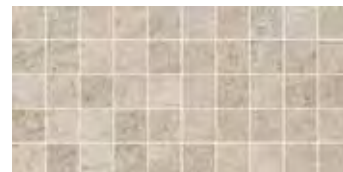

4

QUARTZ beige mosaic A
22,2 x 44,6
MD006-003

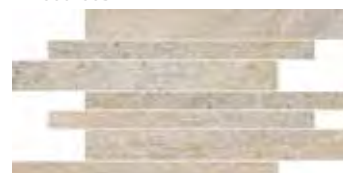

4

QUARTZ beige mosaic B
22,2 x 44,6
MD006-004

ARKOS >

GRES
SZKLIWIONY
**GLAZED
PORCELAIN
TILES**

**SMART
SILVER**



ARKOS cream lappato
44,6 x 89,5
MT005-001-1



R10

4



R10

4

ARKOS cream lappato
44,6 x 44,6
MT005-002-1



4

ARKOS cream mosaic
22,2 x 44,6
MD005-008



ARKOS brown lappato
44,6 x 89,5
MT005-003-1



R10

3



R10

3

ARKOS brown lappato
44,6 x 44,6
MT005-004-1

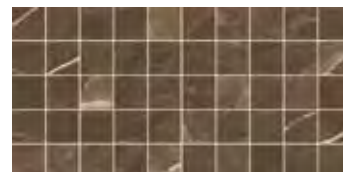

3

ARKOS brown mosaic
22,2 x 44,6
MD005-007



DAINO cream
44,6 x 89,5
MT001-001-1



DAINO beige
44,6 x 89,5
MT001-005-1



DAINO cream lappato
44,6 x 89,5
MT001-003-1



DAINO beige lappato
44,6 x 89,5
MT001-006-1



DAINO cream structure
44,6 x 89,5
MT001-010-1



DAINO beige structure
44,6 x 89,5
MT001-009-1



DAINO cream
44,6 x 44,6
MT001-002-1



DAINO beige
44,6 x 44,6
MT001-007-1

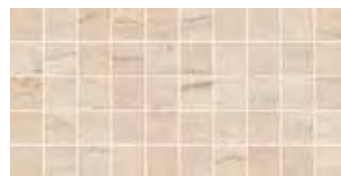

DAINO cream mosaic
22,2 X 44,6
MD001-017

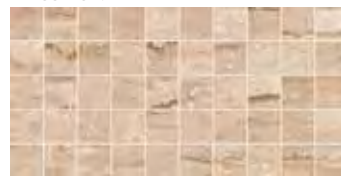

DAINO beige mosaic
22,2 X 44,6
MD001-018



DAINO cream lappato
44,6 x 44,6
MT001-004-1



DAINO beige lappato
44,6 x 44,6
MT001-008-1

**PŁYTKI
CERAMICZNE
ELEWACJE
TARASY
CERAMIC
TILES
BUILDING FAÇADES
AND TERRACES**

PLAYA >

GRES
SZKLIWIONY
**GLAZED
PORCELAIN
TILES**

SMART
SILVER



PLAYA cream lappato
44,6 x 89,5
MT003-001-1

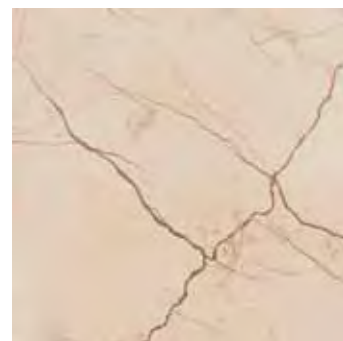

PLAYA cream lappato
44,6 x 44,6
MT003-002-2

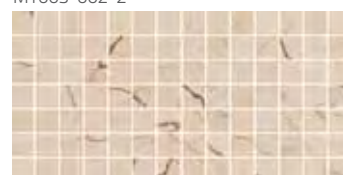

PLAYA cream mosaic
22,2 x 44,6
MD003-003



YAKARA >

GRES
SZKLIWIONY
**GLAZED
PORCELAIN
TILES**

SMART
SILVER

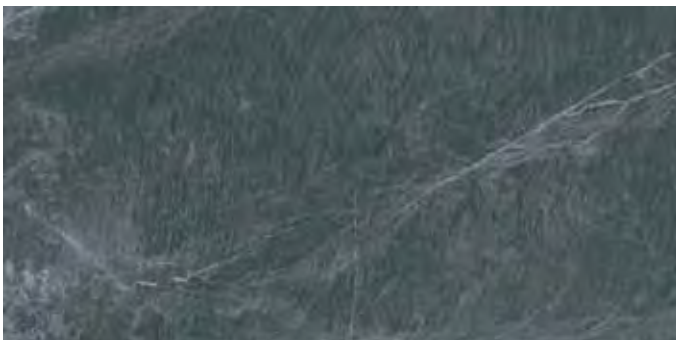

YAKARA graphite
44,6 x 89,5
MT002-009-1

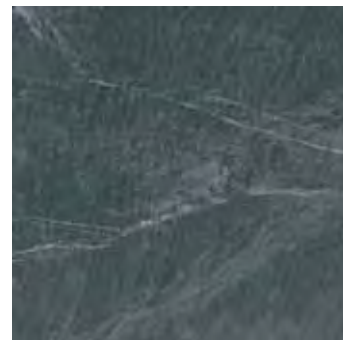

Yakara graphite 44,6 x 44,6
MT002-012-1



YAKARA graphite lappato
44,6 x 89,5
MT002-006-1



YAKARA graphite lappato
44,6 x 44,6
MT002-003-1



YAKARA graphite mosaic
22,2 x 44,6
MD002-016



YAKARA >

GRES
SZKLIWIONY
**GLAZED
PORCELAIN
TILES**

SMART
SILVER

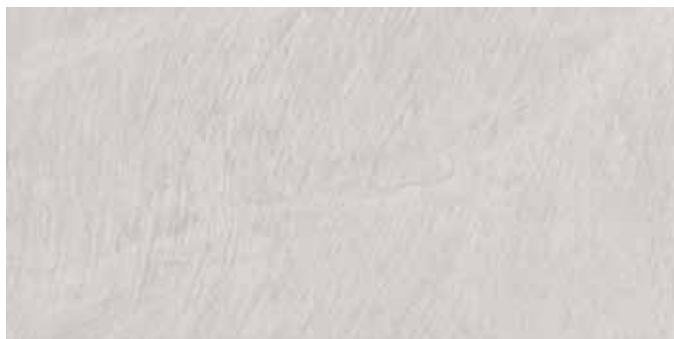

R10

5

YAKARA white
44,6 x 89,5
MT002-007-1



R10

5

YAKARA white
44,6 x 89,5
MT002-010-1

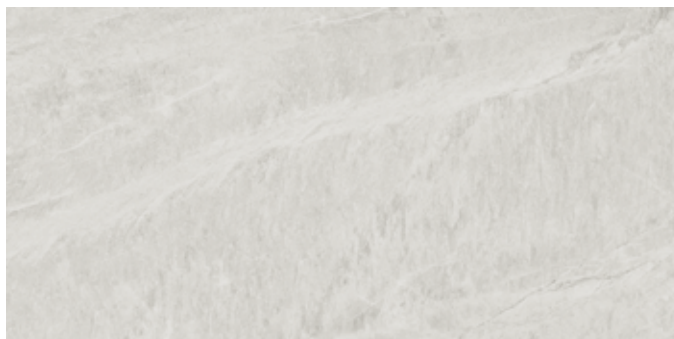

R9

4

YAKARA white lappato
44,6 x 89,5
MT002-004-1



R9

4

YAKARA white lappato
44,6 x 89,5
MT002-001-1

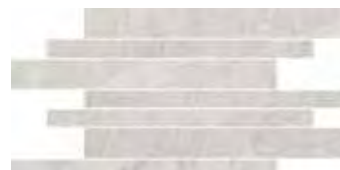

4

YAKARA white mosaic
22,2 x 44,6
MD002-014



R10

3

YAKARA grey 44,6 x 89,5
MT002-008-1

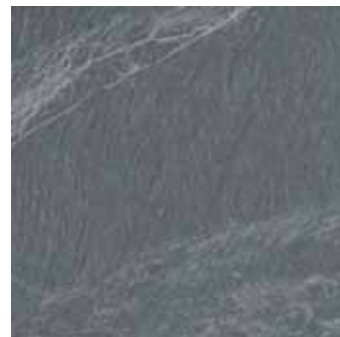

R10

3

YAKARA grey 44,6 x 44,6
MT002-011-1



R9

3

YAKARA grey lappato
44,6 x 89,5
MT002-005-1



R9

3

YAKARA grey lappato
44,6 x 44,6
MT002-002-1



3

YAKARA grey mosaic
22,2 x 44,6
MD002-015

**PRE
STIGE**

**PŁYTKI
CERAMICZNE
ELEWACJE
TARASY
CERAMIC
TILES
BUILDING FAÇADES
AND TERRACÉS**

**LEGNO >
MODERNO**

GRES
SZKLIWIONY
**GLAZED
PORCELAIN
TILES**

SMART
SILVER



LEGNO moderno white
14,7 x 89,5
MT007-001-1



R9

5



LEGNO moderno platinum
14,7 x 89,5
MT007-001-1



R9

3



LEGNO moderno venge
14,7 x 89,5
MT007-001-1



R9

3



LEGNO moderno gold
14,7 x 89,5
MT007-001-1



R9

3

**LEGNO >
RUSTICO**

GRES
SZKLIWIONY
**GLAZED
PORCELAIN
TILES**

SMART
SILVER



LEGNO rustico brown
14,7 x 89,5
MT004-003-1



R10

4



LEGNO rustico cream
14,7 x 89,5
MT004-001-1



R10

5



LEGNO rustico beige
14,7 x 89,5
MT004-002-1



R10

4



LEGNO rustico grey
14,7 x 89,5
MT004-004-1



R10

4

DECKWOOD >

GRES
SZKLIWIONY
GLAZED
PORCELAIN
TILES



DECKWOOD pine
14,8 x 59,8
OP362-001-1



DECKWOOD teak
14,8 x 59,8
OP362-003-1



DECKWOOD oak
14,8 x 59,8
OP362-002-1



DECKWOOD nut
14,8 x 59,8
OP362-004-1

NODO >

GRES
SZKLIWIONY
GLAZED
PORCELAIN
TILES

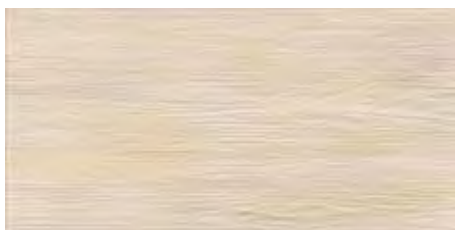

NODO cream
29,7 x 59,8
OP057-001-1



NODO grey rustic
29,7 x 59,8
OP057-005-1



NODO beige
29,7 x 59,8
OP057-002-1



NODO brown
29,7 x 59,8
OP057-003-1

ARTWOOD >

GRES
SZKLIWIONY
GLAZED
PORCELAIN
TILES



ARTWOOD pine mosaic
59,3 x 59,3
OP363-001-1



ARTWOOD nut mosaic
59,3 x 59,3
OP363-002-1



ARTWOOD pine board
59,3 x 59,3
OP363-003-1



ARTWOOD nut board
59,3 x 59,3
OP363-004-1

PRE
STI
GE

MISTY STONE >

GRES
 SZKLIWIONY
GLAZED
PORCELAIN
TILES



4

MISTY STONE beige
 45 x 45
 OP619-002-1



4

MISTY STONE beige border
 45 x 45
 OP619-002-1



4

MISTY STONE beige corner
 45 x 45
 OP619-003-1

FOREST >
TOUCH

GRES
 SZKLIWIONY
GLAZED
PORCELAIN
TILES



4

FOREST TOUCH cream
 45 x 45
 OP618-003-1

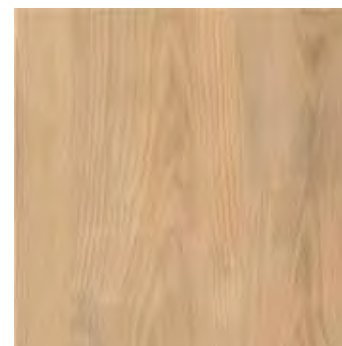

3

FOREST TOUCH beige
 45 x 45
 OP618-001-1

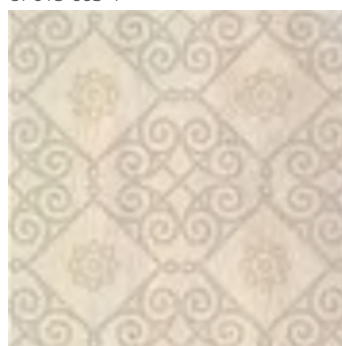

4

FOREST TOUCH cream carpet
 45 x 45
 OP618-004-1

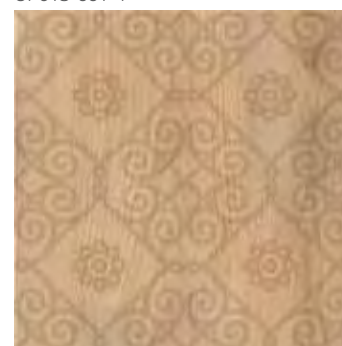

3

FOREST TOUCH beige carpet
 45 x 45
 OP618-002-1

SILENT STONE >

GRES
SZKLIWIONY
GLAZED
PORCELAIN
TILES



SILENT STONE light grey
45 x 45
OP621-003-1



SILENT STONE grey
45 x 45
OP621-001-1



SILENT STONE light grey carpet
45 x 45
OP621-004-1



SILENT STONE grey carpet
45 x 45
OP621-002-1

SCANDIC LIFE >

GRES
SZKLIWIONY
GLAZED
PORCELAIN
TILES



SCANDIC LIFE cream
45 x 45
OP620-002-1

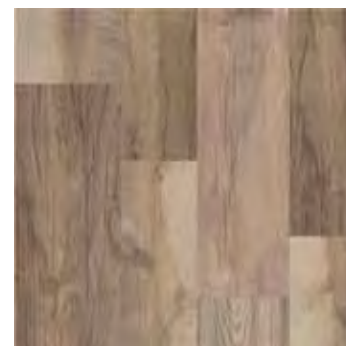

SCANDIC LIFE beige
45 x 45
OP620-001-1



SCANDIC LIFE light grey
45 x 45
OP620-004-1



SCANDIC LIFE grey
45 x 45
OP620-003-1

PRE
STI
GE

**PŁYTKI
CERAMICZNE**
ELEWACJE
TARASY
**CERAMIC
TILES**
BUILDING FAÇADES
AND TERRACÉS

MOJAVE >

GRES
SZKLIWIONY
**GLAZED
PORCELAIN
TILES**

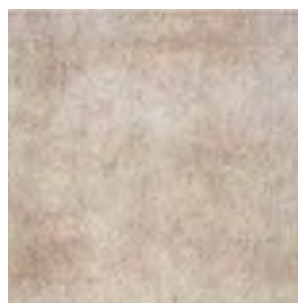

MOJAVE cream
39,6 x 39,6
OP356-001-1

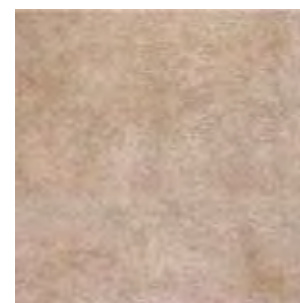

MOJAVE beige
39,6 x 39,6
OP356-002-1



MOJAVE brown
39,6 x 39,6
OP356-003-1

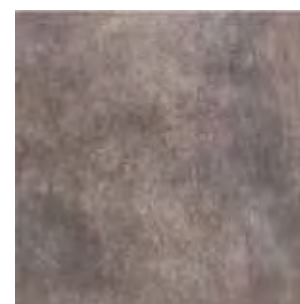

MOJAVE grey
39,6 x 39,6
OP356-004-1



**FOSSILE >
SLATE**

GRES
SZKLIWIONY
**GLAZED
PORCELAIN
TILES**

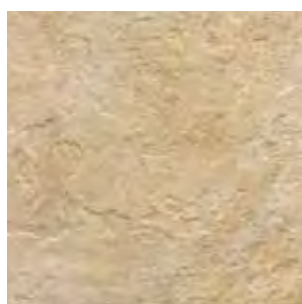

FOSSILE SLATE cream
39,6 x 39,6
OP061-004-1



FOSSILE SLATE beige
39,6 x 39,6
OP061-001-1

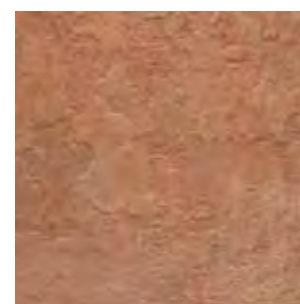

FOSSILE SLATE carmine
39,6 x 39,6
OP061-003-1

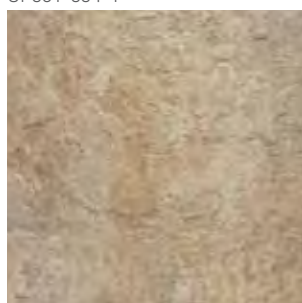

FOSSILE SLATE olive
39,6 x 39,6
OP061-005-1

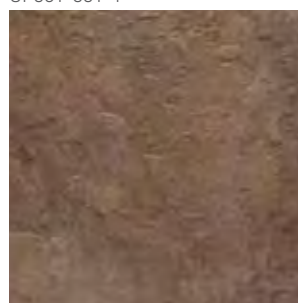

FOSSILE SLATE brown
39,6 x 39,6
OP061-002-1



FOSSILE SLATE mosaic mix
39,6 x 39,6
OD061-007



FOSSILE SLATE mosaic multi
9,8 x 39,6
OD061-006



MILTON >

GRES
SZKLIWIONY
GLAZED
PORCELAIN
TILES



MILTON beige
29,7 x 29,7
OP069-001-1



MILTON yellow
29,7 x 29,7
OP069-013-1



MILTON orange
29,7 x 29,7
OP069-009-1



MILTON brown
29,7 x 29,7
OP069-003-1



MILTON beige steptread
29,7 x 29,7
OP069-002-1

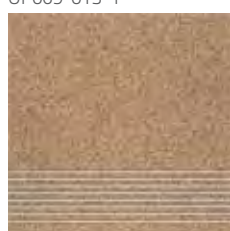

MILTON yellow steptread
29,7 x 29,7
OP069-014-1

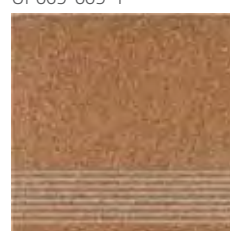

MILTON orange steptread
29,7 x 29,7
OP069-010-1



MILTON brown steptread
29,7 x 29,7
OP069-004-1



MILTON olive
29,7 x 29,7
OP069-007-1



MILTON graphite
29,7 x 29,7
OP069-005-1



MILTON grey
29,7 x 29,7
OP069-011-1



MILTON olive steptread
29,7 x 29,7
OP069-008-1



MILTON graphite steptread
29,7 x 29,7
OP069-006-1



MILTON grey steptread
29,7 x 29,7
OP069-012-1



**STAN
DARD**

SOLAR >
KLINKIER

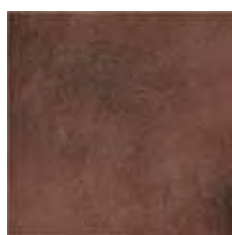

R10

3

SOLAR brown 3d
30 x 30
OP128-007-1



R10

3

SOLAR brown steptread 3d
30 x 30
OP128-010-1



R10

3

SOLAR brown steptread corner 3d
30 x 30
OP128-011-1



3

SOLAR brown under stair 3d
14,8 x 30
OP128-009-1



3

SOLAR brown border
14,8 x 30
OD128-022-1



3

SOLAR brown corner
14,8 x 14,8
OD128-025-1



solar brown elevation 3d
6,5 x 24,5
OP128-008-1



SOLAR brown skirting right 3d
8,1 x 30
OD128-002-1



SOLAR brown skirting left 3d
8,1 x 30
OD128-001-1



SOLAR brown skirting 3d
8 x 30
OD128-028-1



R10

3

SOLAR brown kapinos stright 3d
30 x 33
OD128-033-1



R10

3

SOLAR brown kapinos corner 3d
33 x 33
OD128-029-1



SOLAR brown sill A
14,8 x 30
OD128-030-1



SOLAR brown sill B
13,5 x 24,5
OD128-031-1



SOLAR brown sill C
10 x 20
OD128-032-1



SOLAR graphite 3d
30 x 30
OP128-012-1



SOLAR graphite steptread 3d
30 x 30
OP128-015-1



SOLAR graphite steptread corner 3d
30 x 30
OP128-016-1



SOLAR graphite under stair 3d
14,8 x 30
OP128-014-1



SOLAR graphite border
14,8 x 30
OD128-023-1

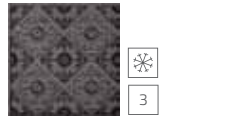

SOLAR graphite corner
14,8 x 14,8
OD128-026-1



SOLAR graphite elevation 3d
6,5 x 24,5
OP128-013-1



SOLAR graphite skirting right 3d
8,1 x 30
OD128-004-1



SOLAR graphite skirting left 3d
8,1 x 30
OD128-003-1



SOLAR graphite kapinos stright 3d
30 x 33
OD128-039-1



SOLAR graphite skirting 3d
8 x 30
OD128-034-1

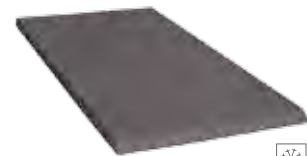

SOLAR graphite sill A
14,8 x 30
OD128-036-1



SOLAR graphite sill B
13,5 x 24,5
OD128-037-1



SOLAR graphite sill C
10 x 20
OD128-038-1



SOLAR graphite kapinos corner 3d
33 x 33
OD128-035-1



SOLAR orange 3d
30 x 30
OP128-017-1

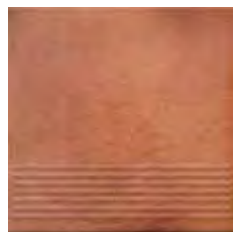

SOLAR orange steptread 3d
30 x 30
OP128-020-1

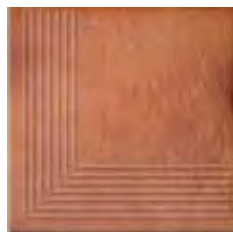

SOLAR orange steptread corner 3d
30 x 30
OP128-021-1



SOLAR orange under stair 3d
14,8 x 30
OP128-019-1



SOLAR orange border
14,8 x 30
OD128-024-1



SOLAR orange corner
14,8 x 14,8
OD128-027-1



SOLAR orange elevation 3d
6,5 x 24,5
OP128-018-1



SOLAR orange skirting right 3d
8,1 x 30
OD128-006-1



SOLAR orange skirting left 3d
8,1 x 30
OD128-005-1



SOLAR orange kapinos stright 3d
30 x 33
OD128-045-1



SOLAR orange sill A
14,8 x 30
OD128-042-1



SOLAR orange sill B
13,5 x 24,5
OD128-043-1



SOLAR orange sill C
10 x 20
OD128-044-1



SOLAR orange kapinos corner 3d
33 x 33
OD128-041-1

**PŁYTKI
CERAMICZNE
ELEWACJE
TARASY
CERAMIC
TILES
BUILDING FAÇADES
AND TERRACÉS**

**SIMPLE >
KLINKIER**

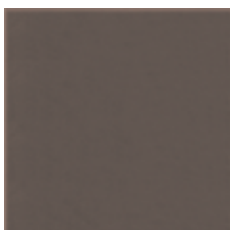

SIMPLE brown
30 x 30
OP078-001-1



SIMPLE brown 3d
30 x 30
OP078-002-1

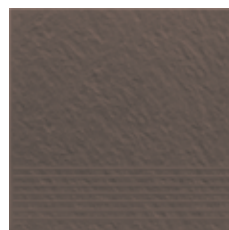

SIMPLE brown steptread 3d
30 x 30
OP078-008-1

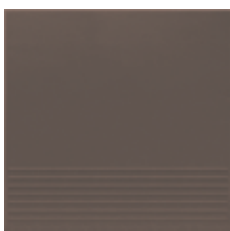

SIMPLE brown steptread
30 x 30
OP078-007-1



SIMPLE brown steptread corner
30 x 30
OP078-009-1

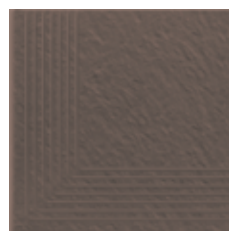

SIMPLE brown steptread corner 3d
30 x 30
OP078-010-1



SIMPLE brown skirting right
8 x 30
OD078-061-1



SIMPLE brown skirting left
8 x 30
OD078-059-1



SIMPLE brown skirting right 3d
8 x 30
OD078-062-1



SIMPLE brown skirting left 3d
8 x 30
OD078-060-1



SIMPLE brown elevation
6,5 x 24,5
OP078-003-1



SIMPLE brown kapinos stright
30 x 33
OD078-039-1



SIMPLE brown kapinos corner
33 x 33
OD078-034-1



SIMPLE brown skirting
8 x 30
OD078-032-1



SIMPLE brown kapinos stright 3d
30 x 33
OD078-040-1



SIMPLE brown kapinos corner 3d
33 x 33
OD078-035-1



SIMPLE brown elevation 3d
6,5 x 24,5
OP078-004-1



SIMPLE brown skirting 3d
8 x 30
OD078-033-1



SIMPLE brown sill A
14,8 x 30
OD078-036-1



SIMPLE brown sill B
13,5 x 24,5
OD078-037-1



SIMPLE brown under stair
14,8 x 30
OP078-005-1



SIMPLE brown sill C
10 x 20
OD078-038-1



SIMPLE brown under stair 3d
14,8 x 30
OP078-006-1





SIMPLE red
30 x 30
OP078-011-1



SIMPLE red 3d
30 x 30
OP078-012-1



SIMPLE red steptread 3d
30 x 30
OP078-018-1



SIMPLE red steptread
30 x 30
OP078-017-1



SIMPLE red steptread corner
30 x 30
OP078-020-1



SIMPLE red steptread corner 3d
30 x 30
OP078-021-1



SIMPLE red skirting right
8 x 30
OD078-065-1



SIMPLE red skirting left
8 x 30
OD078-063-1



SIMPLE red skirting right 3d
8 x 30
OD078-066-1



SIMPLE red skirting left 3d
8 x 30
OD078-064-1



SIMPLE red kapinos stright
30 x 33
OD078-048-1



SIMPLE red kapinos corner
33 x 33
OD078-043-1



SIMPLE red kapinos stright 3d
30 x 33
OD078-049-1



SIMPLE red kapinos corner 3d
33 x 33
OD078-044-1

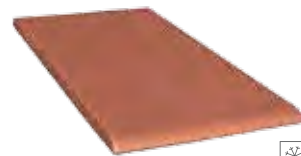

SIMPLE red sill A
14,8 x 30
OD078-045-1



SIMPLE red sill B
13,5 x 24,5
OD078-046-1



SIMPLE red sill C
10 x 20
OD078-047-1



SIMPLE red elevation
6,5 x 24,5
OP078-013-1



SIMPLE red skirting
8 x 30
OD078-041-1



SIMPLE red elevation 3d
6,5 x 24,5
OP078-014-1



SIMPLE red skirting 3d
8 x 30
OD078-042-1



SIMPLE red under stair
14,8 x 30
OP078-015-1



SIMPLE red under stair 3d
14,8 x 30
OP078-016-1

**PŁYTKI
CERAMICZNE
ELEWACJE
TARASY
CERAMIC
TILES
BUILDING FAÇADES
AND TERRACES**

**SHADOW >
KLINKIER**

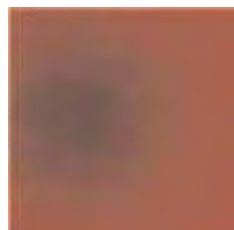

SHADOW red
30 x 30
OP077-011-1



SHADOW red 3d
30 x 30
OP077-012-1

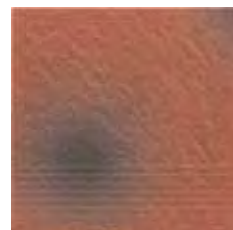

SHADOW red steptread 3d
30 x 30
OP077-018-1

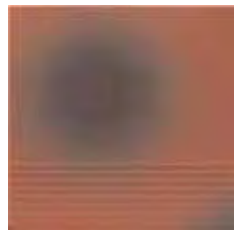

SHADOW red steptread
30 x 30
OP077-017-1

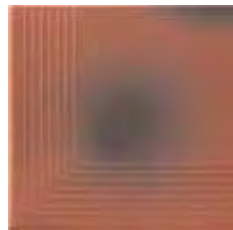

SHADOW red steptread corner
30 x 30
OP077-019-1



SHADOW red steptread corner 3d
30 x 30
OP077-020-1



SHADOW red skirting right
8,1 x 30
OD077-045-1



SHADOW red skirting left
8,1 x 30
OD077-043-1



SHADOW red skirting right 3d
8,1 x 30
OD077-046-1



SHADOW red skirting left 3d
8,1 x 30
OD077-044-1



SHADOW red elevation
6,5 x 24,5
OP077-013-1



SHADOW red kapinos straight
30 x 33
OD077-037-1



SHADOW red kapinos corner
33 x 33
OD077-032-1



SHADOW red skirting
8,1 x 30
OD077-030-1



SHADOW red kapinos straight 3d
30 x 33
OD077-038-1



SHADOW red kapinos corner 3d
33 x 33
OD077-033-1

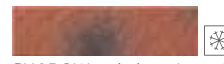

SHADOW red elevation 3d
6,5 x 24,5
OP077-014-1



SHADOW red sill A
14,8 x 30
OD077-034-1

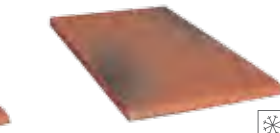

SHADOW red sill B
13,5 x 24,5
OD077-035-1



SHADOW red skirting 3d
8,1 x 30
OD077-031-1

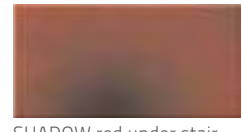

SHADOW red under stair
14,8 x 30
OP077-015-1



SHADOW red sill C
10 x 20
OD077-036-1



SHADOW red under stair 3d
14,8 x 30
OP077-016-1



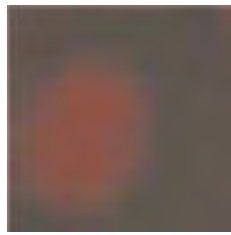

SHADOW brown
30 x 30
OP077-001-1

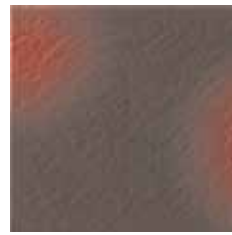

SHADOW brown 3d
30 x 30
OP077-002-1



SHADOW brown steptread 3d
30 x 30
OP077-008-1

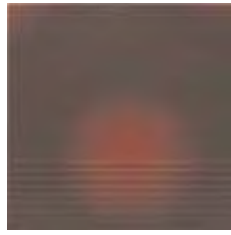

SHADOW brown steptread
30 x 30
OP077-007-1



SHADOW brown steptread corner
30 x 30
OP077-009-1

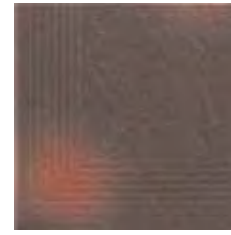

SHADOW brown steptread corner 3d
30 x 30
OP077-010-1



SHADOW brown skirting right
8,1 x 30
OD077-041-1



SHADOW brown skirting left
8,1 x 30
OD077-039-1



SHADOW brown skirting right 3d
8,1 x 30
OD077-042-1



SHADOW brown skirting left 3d
8,1 x 30
OD077-040-1



SHADOW brown elevation
6,5 x 24,5
OP077-003-1

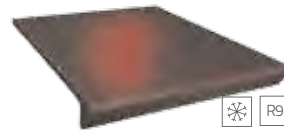

SHADOW brown kapinos straight
30 x 33
OD077-028-1

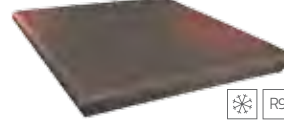

SHADOW brown kapinos corner
33 x 33
OD077-023-1



SHADOW brown skirting
8,1 x 30
OD077-021-1



SHADOW brown kapinos straight 3d
30 x 33
OD077-029-1



SHADOW brown kapinos corner 3d
33 x 33
OD077-024-1



SHADOW brown elevation 3d
6,5 x 24,5
OP077-004-1

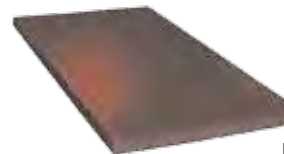

SHADOW brown sill A
14,8 x 30
OD077-025-1



SHADOW brown sill B
13,5 x 24,5
OD077-026-1



SHADOW brown skirting 3d
8,1 x 30
OD077-022-1

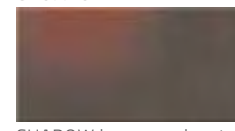

SHADOW brown under stair
14,8 x 30
OP077-005-1



SHADOW brown sill C
10 x 20
OD077-027-1



SHADOW brown under stair 3d
14,8 x 30
OP077-006-1

STANDARD

CERAMIKA
SANITARNA
SANITARY
CERAMICS



INNOWACYJNA POWŁOKA FLUOROPOLIMEROWA
INNOVATIVE FLUOROPOLYMER COATING
PERFECT CLEAN

Standardowa powierzchnia ceramiki tylko z pozoru jest idealnie gładka. Pod mikroskopem widoczna jest porowata powierzchnia z mnóstwem zagłębień. Substancje mineralne zawarte w wodzie osadzają się w zagłębieniach powierzchni tworząc trudny do usunięcia osad. Aplikowana w procesie produkcji powłoka **PERFECT CLEAN** niweluje porowatość powierzchni, nie dając szansy osadom. Zmniejsza również energię powierzchniową, przez co odpycha wodę, która w formie drobnych kropelek spływa swobodnie po powierzchni nie pozostawiając osadu.

Standard surfaces of ceramic tiles may seem perfectly smooth. When viewed under a microscope, however, the surface of tiles proves to be porous. Mineral substances present in water build up on the surface of tiles, leaving deposits that are hard to remove. **PERFECT CLEAN**, a coating applied to tiles in the manufacturing process, eliminates surface porosity and prevents the buildup of deposits. By reducing surface energy, it repels water, causing it to roll down the surface of tiles in small drops without leaving residue.



Ceramika typowa
Typical ceramics



Ceramika Opoczno
Opoczno ceramics

**PERFECT
CLEAN**

GŁADKA POWIERZCHNIA
bez porowatości, w których
pozostaje osad

ODPYCHANIE WODY
drobne krople wody „staczają się”
z powierzchni

SMOOTH SURFACE
no pores and no residue

WATER REPELLENCE
small drops of water roll down
the surface of tiles

POWŁOKA
COATING
CLEAN PRO

Na powierzchniach pokrytych powłoką Clean Pro krople wody łączą się ze sobą i w większych skupiskach szybko spływają wraz ze wszelkimi zanieczyszczeniami, nie pozostawiając zacieków, co ogranicza tworzenie się osadów z mydła i kamienia. Powierzchnie te pozostają na długo czyste, ich pielęgnacja jest wyjątkowo szybka i prosta, nie wymaga uporczywego szorowania ani użycia silnych środków chemicznych, a efekt czystości utrzymuje się przez wiele dni.



Powierzchnia bez powłoki
A surface without the coating



Powierzchnia
z powłoką Clean Pro
A surface with Clean Pro coating

CleanPro 

On a surface with the Clean Pro coating, droplets of water combine and quickly run off the surface, taking any dirt with them and leaving behind no smudges. This limits the buildup of soap and limescale deposits. Such surfaces stay clean for a long time and caring for them is exceptionally quick and easy, without requiring scrubbing or the use of strong cleaning substances. The crystal-clean effect lasts many days.

PURE SILVER PROTECT

Najnowszym rozwiązaniem wprowadzonym do naszej szerokiej oferty wyposażenia łazienek jest innowacyjna technologia antybakteryjna Pure Silver Protect®.

W produkty serii Pure wkomponowaliśmy aktywny składnik Silverit. Badania potwierdzają, że zawarte w nim jony srebra ograniczają namnażanie się bakterii o 99,8%. * Technologia wykorzystywana jest we wszystkich wyrobach linii Cersanit Pure Silver Protect®: ceramice sanitarnej (umywalkach, miskach podwieszanych, wc kompaktach, bidetach) i jej akcesoriach uzupełniających (deskach, przyciskach do spłukiwania), wannach akrylowych oraz meblach (słupkach, szafkach lustrzanych i podumywalkowych).

Silverit eliminuje szkodliwe mikroorganizmy skuteczniej niż tradycyjne, chemiczne środki czystości. Zapobiega rozwojowi nie tylko bakterii, ale też grzybów. Z upływem czasu nie traci swych właściwości. Nie ulega zużyciu. Technologia Pure Silver Protect® ma długoletni okres działania, co potwierdzamy, udzielając 25-letniej gwarancji na ochronę antybakteryjną.

Wszystkie te właściwości sprawiają, że produkty z linii Cersanit Pure Silver Protect® stanowią optymalne rozwiązanie do obiektów o podwyższonych wymaganiach w zakresie higieny. Doskonale sprawdzą się w łazienkach szpitalnych, szkolnych, na basenach, w obiektach sportowych i innych pomieszczeniach publicznych, w których najwyższym priorytetem jest utrzymanie czystości.

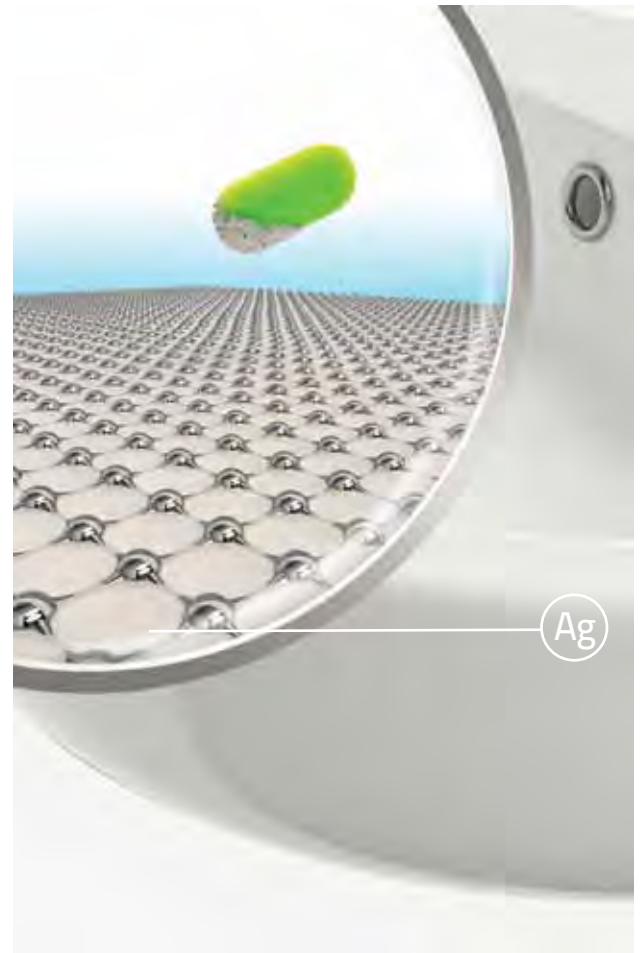

Pure Silver Protect®, an innovative anti-bacterial technology, is the latest solution introduced in Rovese's comprehensive range of bathroom fixtures. Products from the Pure line include the active component Silverit. Studies confirm that silver ions included in the component reduce the growth of bacteria by 99.8%.*

This technology is used in all products from the Cersanit Pure Silver Protect® line: sanitary ceramics (washbasins, wall-hung bowls, WC compacts, bidets) and complementary accessories (toilet seats, flush buttons), acrylic bathtubs, and furniture (tall, mirror, and washbasin cabinets).

Silverit eliminates harmful microorganisms more effectively than traditional chemical cleaning agents. It prevents the growth of both bacteria and fungi. It does not lose its properties over time or wear off. Pure Silver Protect® is a long-lasting technology and comes with a 25-year warranty for anti-bacterial protection.

All these properties make products from the Cersanit Pure Silver Protect® line an optimum choice for facilities with high hygiene requirements. They are excellently suited for hospital and school bathrooms, swimming pools, sports facilities, and other public-access spaces where cleanness is a top priority.

zwykła
powierzchnia
ceramiczna
ordinary
ceramic
surface

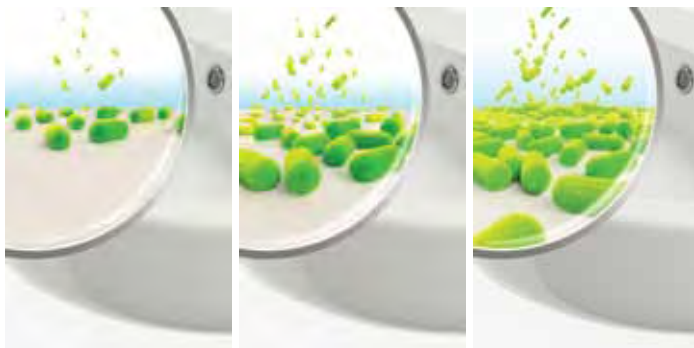

1 DZIEŃ
1 DAY

1 TYDZIEŃ
1 WEEK

2 TYGODNIE
2 WEEKS

powierzchnia
ceramiczna
PURE SILVER
PROTECT
PURE SILVER
PROTECT
ceramic
surface

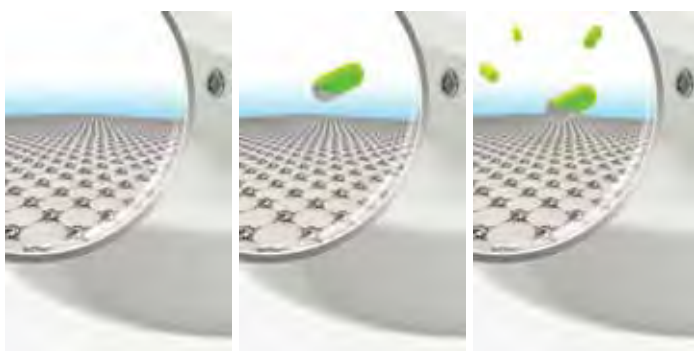

1 DZIEŃ
1 DAY

1 TYDZIEŃ
1 WEEK

2 TYGODNIE
2 WEEKS

* Badanie wykonane przez NanoHorizons Inc. na zlecenie Advanced Nano Technologies dla Rovese S.A. na obecność bakterii Escherichia coli i Staphylococcus aureus, 17.05.2012.

* Tests for the presence of the bacteria Escherichia coli and Staphylococcus aureus, conducted by NanoHorizons Inc. and commissioned by Advanced Nano Technologies for Rovese S.A., 17 May 2012.

CLEAN ON

W tradycyjnych miskach, pod obrzeżem muszli znajdują się trudno dostępne przestrzenie, w których gromadzą się szkodliwe dla zdrowia brud i zarazki.

Woda obmywająca miskę nie zawsze dociera do tych miejsc, przez co zgromadzone tam bakterie mogą się namnażać, a utrzymanie toalety w czystości staje się wyzwaniem.

Czyszczenie tych powierzchni jest skomplikowane i często mało skuteczne ze względu na kołnierz, który utrudnia dostęp do nich, nawet gdy używa się specjalnie wyprofilowanej szczotki i silnych detergentów.



Traditional toilet bowls have hard-to-reach areas under the rim where dangerous to health bacteria can accumulate.

The water flushing through the bowl does not always reach such spots, and so bacteria can multiply there.

This is why keeping the toilet clean becomes a challenge.

Cleaning those surfaces is complicated and frequently ineffective due to the overhanging rim. It hampers access to them, even when one uses a specially profiled brush and strong detergents.

NO RIM

BRAK KOŁNIERZA

cleanON[®]

Z miski toaletowej został usunięty wewnętrzny kołnierz, a tym samym trudno dostępne zakamarki.

The internal overhanging rim was removed from the toilet bowl, thereby eliminating the hard-to-reach surfaces.

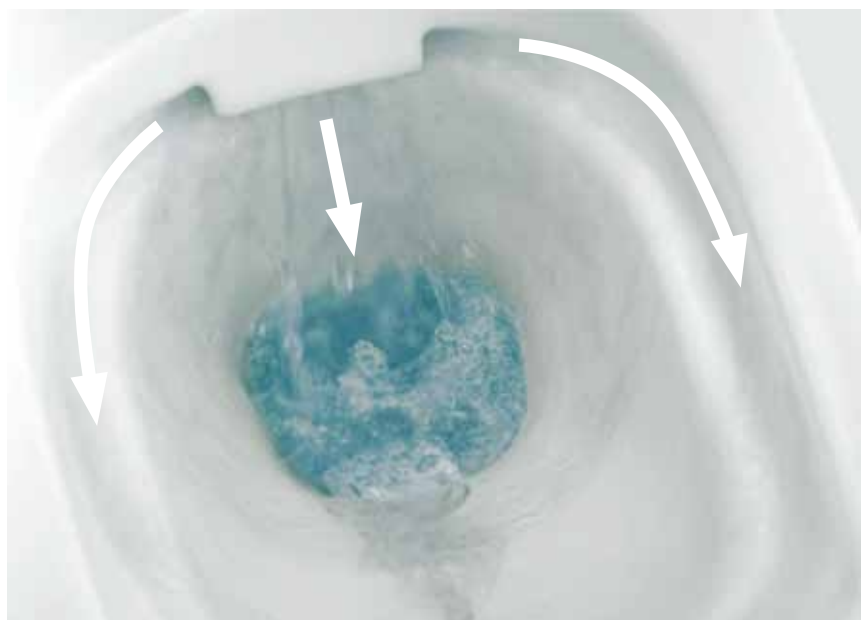

INNOWACYJNA TECHNOLOGIA SPŁUKIWANIA WODY
INNOVATIVE WATER FLUSHING TECHNOLOGY

Teraz woda idealnie obmywa wszystkie wewnętrzne powierzchnie muszli, pozostawiając ją czystą i świeżą.

Now flushing water thoroughly washes all the internal surfaces of the bowl effectively, leaving it clean and fresh.

CERAMIKA
SANITARNA
CECHY
PRODUKTÓW
SANITARY
CERAMICS
PRODUCT
FEATURES

UMYWALKI
KOMPAKTY
DESKI
WASH BASINS
WC COMPACTS
TOILET SEATS

10
YEAR
WARRANTY

10 LAT GWARANCJI NA CERAMIKĘ
10-YEAR WARRANTY FOR CERAMICS

Wysoka jakość ceramiki Rovese daje komfort użytkowania przez wiele lat.
Rovese's top quality ceramics means comfort of use for many years.



ODPORNOŚĆ NA OBCIĄŻENIA
WEIGHT CAPACITY

Produkty ceramiczne Rovese są odporne na nawet bardzo duże obciążenia. Miski zawieszane i bidety do 400 kg, a umywalki do 150 kg.
Rovese's ceramic products are characterized by high weight capacity (up to 400 kg for wall-hung bowls and up to 150 kg for wash-basins).

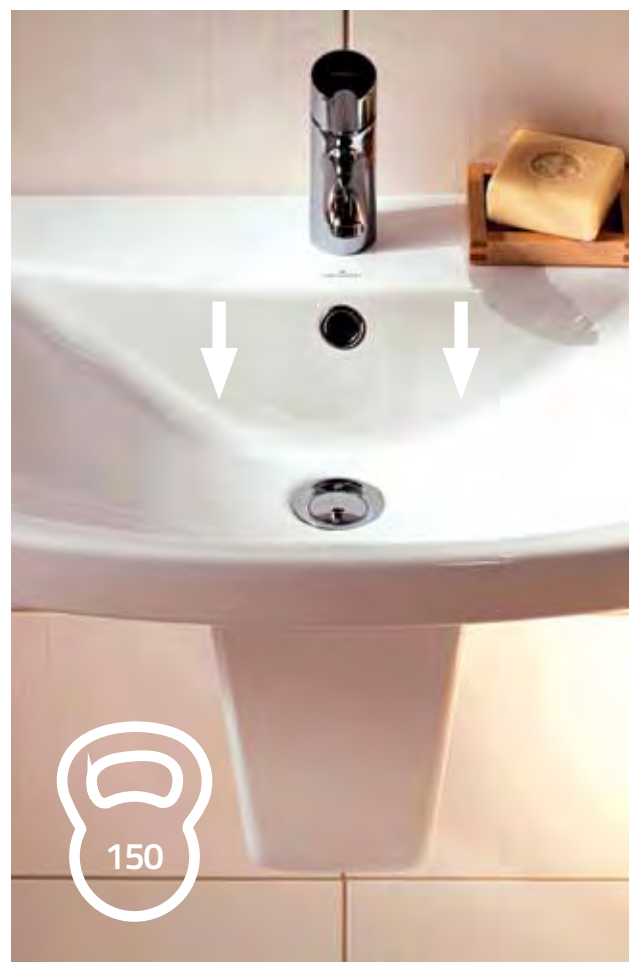

CERAMIKA W 100% SZKLIWIONA
POWIERZCHNIA UŻYTKOWA
CERAMICS: 100% GLAZED SURFACE

Gładkie, w pełni szkliwione powierzchnie naszej ceramiki pozwalają w prosty sposób dbać o czystość i higienę w łazienkach.

With their smooth and fully glazed surfaces, our ceramic products are designed to ensure easy cleaning and help maintain hygiene in bathrooms.



DOSTĘPNE W WIELU WARIANTACH
AVAILABLE IN MULTIPLE FORMATS

Większość modeli naszych umywalek dostępna jest w wielu rozmiarach a niektóre serie oferowane są również w wersji lewa/prawa. Tak szeroki wybór pozwala na dobranie umywalki do wnętrza dowolnej wielkości i w każdym stylu.

Most washbasins are available in multiple sizes and some series also feature left- and right-hand options. Such a wide selection of products makes it possible to choose washbasins for interiors of any size or style.

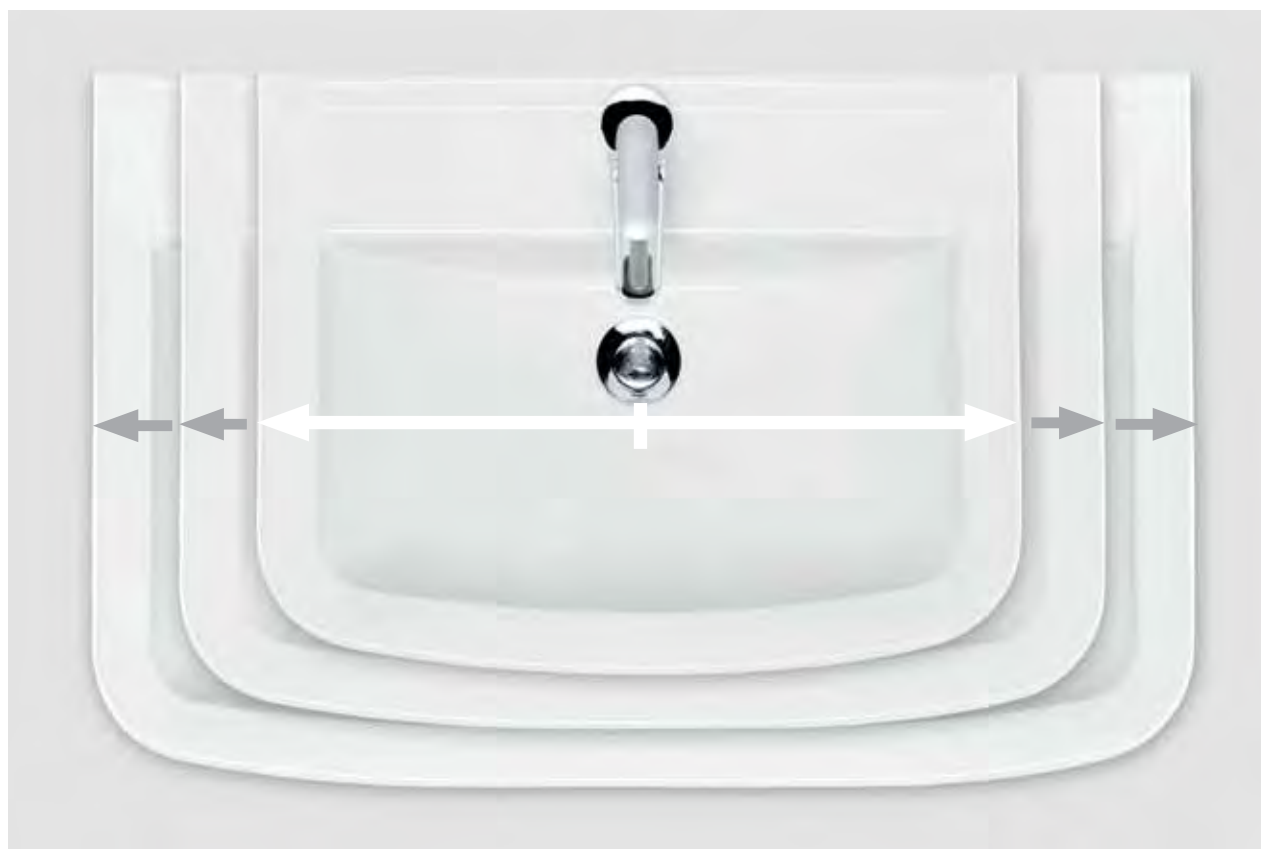

**CERAMIKA
SANITARNA**
CECHY
PRODUKTÓW
SANITARY
CERAMICS
PRODUCT
FEATURES

UMYWALKI
KOMPAKTY
DESKI
**WASH BASINS
WC COMPACTS
TOILET SEATS**

2
YEAR
WARRANTY

2 LATA GWARANCJI NA DESKĘ
2-YEAR WARRANTY FOR TOILET SEATS

Wysoka jakość desek sedesowych naszej produkcji daje komfort użytkowania przez wiele lat...

Rovese's top quality toilet seats provide comfort of use for many years...



OSZCZĘDNE SPŁUKIWANIE
WATER-CONSERVING FLUSH SYSTEM

Zastosowany w naszych kompaktach system spłukiwania 3/6 oraz 2/4 to bardzo ekonomiczne rozwiązanie, pozwalające na oszczędność wody. W systemie 2/4 zastosowanym w serii Nano oszczędność wody jest na poziomie nawet do 30% w stosunku do tradycyjnych systemów spłukiwania. Rovese's dual flush toilet systems (3/6 liters and 2/4 liters) are water efficient flush solutions. Nano products with the 2/4 dual flush system are up to 30% more water efficient than traditional flush systems.

DUROPLAST NAJWYŻSZEJ JAKOŚCI
TOP-QUALITY DUROPLAST

Dzięki zastosowaniu tworzywa jakim jest duroplast, nasze deski są trwałe i nie ulegają przebarwieniom. Made of Duroplast material, our toilet bowls are durable and do not become discolored.



2/4

3/6

ŁATWE WYPINANIE DESKI
EASY-DETACH TOILET SEATS

to funkcjonalne rozwiązanie znacznie ułatwia utrzymanie toalety w czystości.

A functional solution for easy cleaning of toilets.

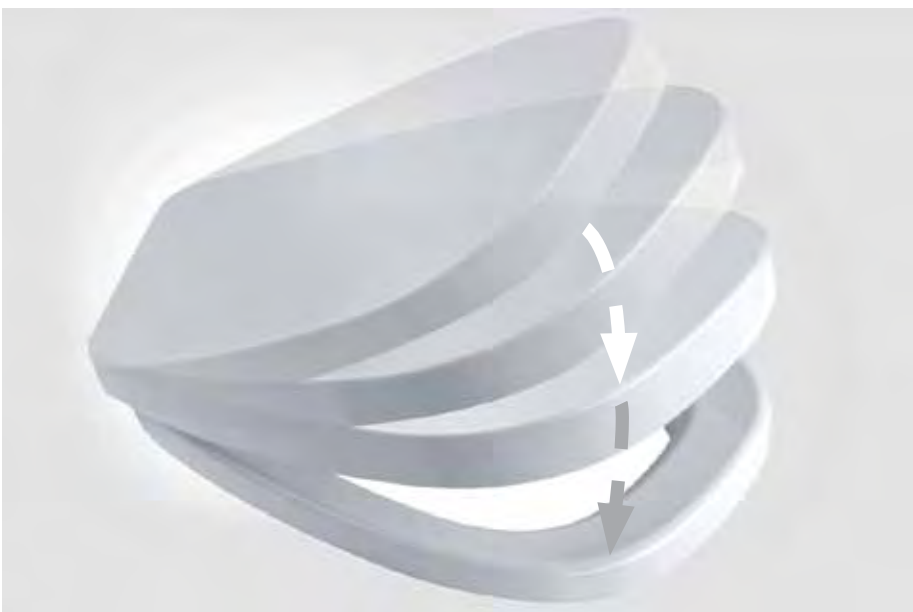

DESKA WOLNOOPADAJĄCA
SOFT-CLOSE TOILET SEATS

Do większości kompaktów i misek zawieszanych oferujemy deski z systemem wolnego opadania, co pozwala na samoistne i ciche zamykanie.

Soft-close toilet seats, available for most closed coupled toilets and wall-hung bowls, come down gently and quietly.

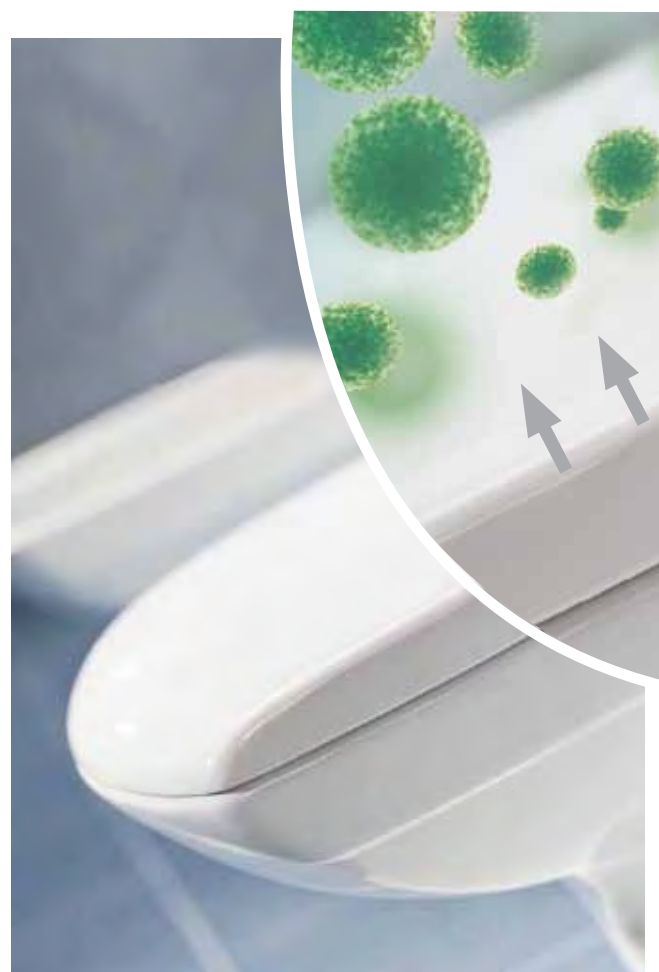

POWŁOKA ANTYBAKTERYJNA
ANTI-BACTERIAL COATING

Dzięki powłoce antybakteryjnej desek sedesowych korzystanie z toalety jest higieniczne i komfortowe. Toilet seats with an anti-bacterial coating designed for comfort and hygiene.

ZESTAWIENIE CERAMIKI COMPARISON OF CERAMIC PRODUCTS

PRE
STI
GE

	WC KOMPAKT WC COMPACT	MISKA ZAWIESZANA WALL HUNG BOWL	BIDET STOJĄCY STAND BIDET	BIDET ZAWIESZANY WALL HUNG BIDET
Carina CLEAN ON	▪	▪		
Easy	▪	▪		
Como	▪	▪		
Colour	▪	▪		
Malmo		▪		▪
Kioto		▪		▪
Bilbao		▪		▪
Pure	▪	▪	▪	▪
Olimpia	▪	▪	▪	▪
Carina	▪	▪		▪
Ontario				
Amao				
Zuro				
Inteo				
Caspia				
Calla				
Gamma				

ZESTAWIENIE CERAMIKI COMPARISON OF CERAMIC PRODUCTS

STANDARD	WC KOMPAKT WC COMPACT	MISKA ZAWIESZANA WALL HUNG BOWL	BIDET STOJĄCY STAND BIDET	BIDET ZAWIESZANY WALL HUNG BIDET
Parva CLEAN ON	▪	▪		
Arteco	▪	▪		
Arteca	▪	▪		
Iryda	▪	▪	▪	▪
Nano	▪	▪		
Facile	▪	▪		
President	▪	▪		
Carla				
Cersania				
Roma				
Omega				
Libra				
Eko				
Sigma				
Teta				
Delfi		▪		▪
Zenit	▪			
Merida	▪			



CERAMIKA
SANITARNA
UMYWALKI
SANITARY
CERAMICS
WASHBASINS

Nº 1





**CERAMIKA
SANITARNA**
UMYWALKI
SANITARY
CERAMICS
WASHBASINS



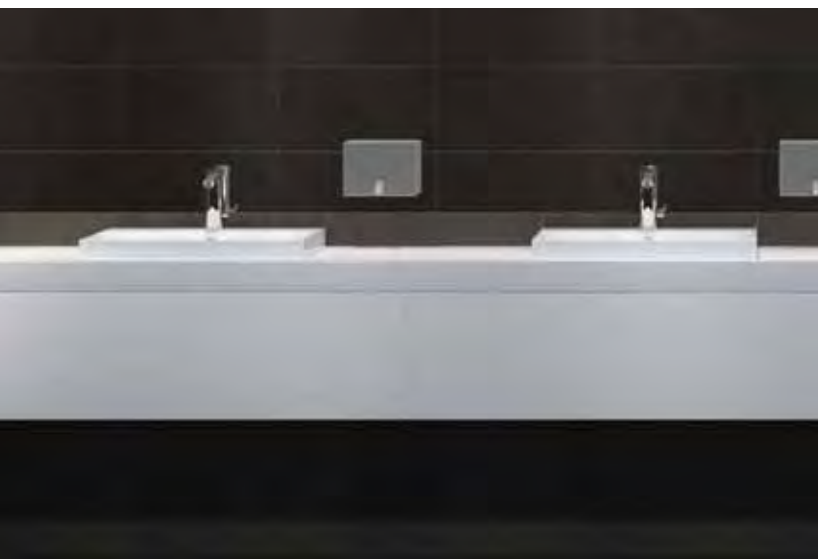

Umywalki konglomeratowe Amao
Pisuary: Taurus
Płytki: Damasco anthracite
Amao conglomerate washbasins
Taurus urinals
Ceramic tiles: Damasco anthracite

CleanPro

niewidzialna powłoka,
ograniczająca osadzanie się ka-
mienia i brudu/ invisible coating,
limiting deposition of both scale
and dirt

EASY >

Umywalka
EASY 50
**EASY 50
washbasin**
50x43cm
Z otworem na
armaturę,
montaż do
ściany
With hole for
mixer, assembly
on walls.

NOWOŚĆ/NEW

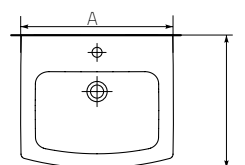

		A (cm)	B (cm)	C (cm)
umywalka EASY 50 EASY 50 washbasin	K102-012	50	43	13,5
umywalka EASY 55 EASY 55 washbasin	K102-013	55,5	44,5	14
umywalka EASY 60 EASY 60 washbasin	K102-014	60,5	45,5	14,5
umywalka EASY 70 EASY 70 washbasin	K102-015	70,5	45,5	15

COMO

Umywalka
COMO 60
**COMO 60
washbasin**
60x40cm
Z otworem na
armaturę,
montaż do
ściany
With hole for
mixer, assembly
on walls.

NOWOŚĆ/NEW

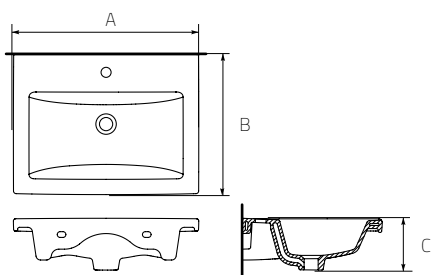

Umywalka
COMO 40
**COMO 40
washbasin**
40x22cm
Z otworem na
armaturę,
montaż na
blacie
With hole for
mixer, assembly
on countertop

NOWOŚĆ/NEW

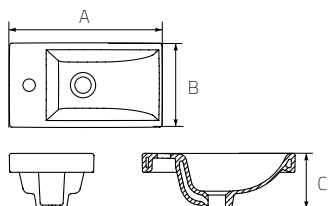

		A (cm)	B (cm)	C (cm)
umywalka COMO 40 COMO 40 washbasin	K32-001- BOX	40	22	14,5
umywalka COMO 50 COMO 50 washbasin	K32-002- BOX	50	40	15,5
umywalka COMO 60 COMO 60 washbasin	K32-003- BOX	60	45	16,5
umywalka COMO 80 COMO 80 washbasin	K32-004- BOX	80	45	16,5

COLOUR

Umywalka
COLOUR 50
**COLOUR 50
washbasin**
50,5x40,5cm
Z otworem na
armaturę,
montaż do
ściany
With hole for
mixer, assembly
on walls.

NOWOŚĆ/NEW

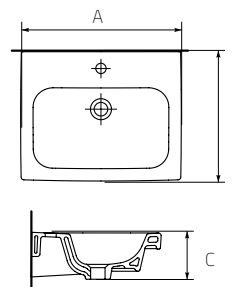

		A (cm)	B (cm)	C (cm)
umywalka COLOUR 50 COLOUR 50 washbasin	K103-005	50,5	40,5	14,5
umywalka COLOUR 55 COLOUR 55 washbasin	K103-006	55,5	45,5	14,5
umywalka COLOUR 60 COLOUR 60 washbasin	K103-007	60,5	45	15

MALMO >

Umywalka
MALMO 60
**MALMO 60
washbasin**
60x49cm
Z otworem
na armaturę,
montaż
do ściany
lub na blacie.
With hole for
mixer, assembly
on walls or
on a countertop.

**PERFECT
CLEAN**

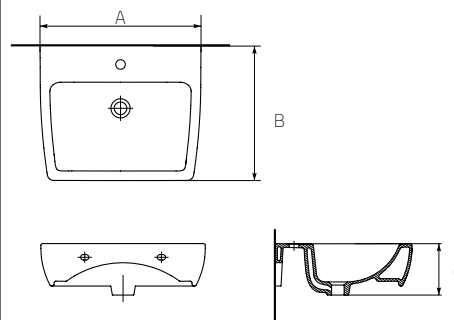

		A (cm)	B (cm)	C (cm)
umywalka MALMO 60	OK-01-001	60	49	18,5
MALMO 60 washbasin				

KIOTO >

Umywalka
KIOTO 70
**KIOTO 70
washbasin**
70,5x54cm
Z otworem
na armaturę,
montaż z półpo-
stumentem lub
na blacie.
With hole for
mixer, assembly
with a semi-pe-
destal or on a
countertop.

**PERFECT
CLEAN**

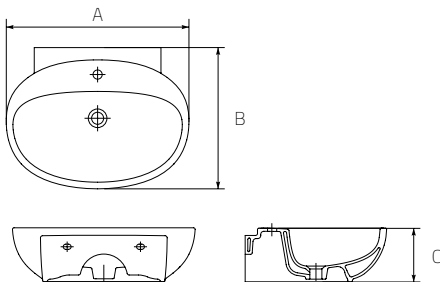

półpostument
KIOTO
**KIOTO
semi-pedestal**
25x36cm



		A (cm)	B (cm)	C (cm)
umywalka KIOTO 70 KIOTO 70 washbasin	OK-02-001	70,5	54	21
umywalka KIOTO 80 KIOTO 80 washbasin	OK-02-002	81	55	21
półpostument KIOTO KIOTO semi-pedestal	OK-02-004	25	36	29,5

BILBAO >

Umywalka
BILBAO 90
**BILBAO 90
washbasin**
91x45,5cm
Z otworem
na armaturę,
montaż do
ściany
lub na blacie.
With hole for
mixer, assembly
on walls or
on a countertop.

**PERFECT
CLEAN**

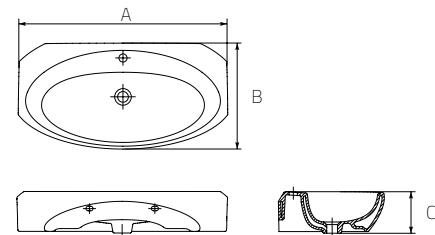

		A (cm)	B (cm)	C (cm)
umywalka BILBAO 70 BILBAO 70 washbasin	OK-03-003	71	45	18
umywalka BILBAO 90 BILBAO 90 washbasin	OK-03-004	91	45,5	18

**CERAMIKA
SANITARNA
UMYWALKI
SANITARY
CERAMICS
WASHBASINS**

PURE >

Umywalka
PURE 60
**PURE 60
washbasin**
60x46 cm
Z otworem
na armaturę,
montaż
z postumentem,
lub półpostu-
mentem.
With hole for
mixer, assembly
with a pedestal
or semi-pede-
stal.

PURE SILVER
PROJECT

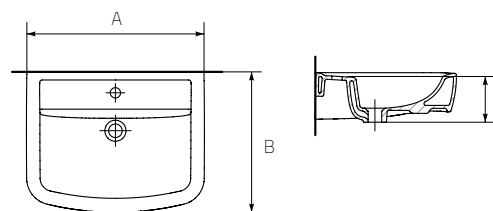

półpostument
PURE
**PURE
semi-pedestal**
20x29,5 cm



postument
PURE
**PURE
pedestal**
16x16 cm



		A (cm)	B (cm)	C (cm)
umywalka PURE 50 PURE 50 washbasin	K101-009 -BOX	50	40	14
umywalka PURE 55 PURE 55 washbasin	K101-010 -BOX	55	42,5	14,5
umywalka PURE 60 PURE 60 washbasin	K101-011 -BOX	60	46	15
umywalka PURE 70 PURE 70 washbasin	K101-007 -BOX	70	47	15
umywalka PURE 80 PURE 80 washbasin	K101-008 -BOX	80	46,5	15
postument PURE PURE pedestal	K101-004 -BOX	16	16	69
półpostument PURE PURE semi-pedestal	K101-003 -BOX	20	29,5	33

OLIMPIA >

Umywalka
OLIMPIA 80
**OLIMPIA 80
washbasin**
81×48,5 cm
Z otworem na
armaturę.
Montaż do
ściany.
With hole for
mixer, assembly
on walls.

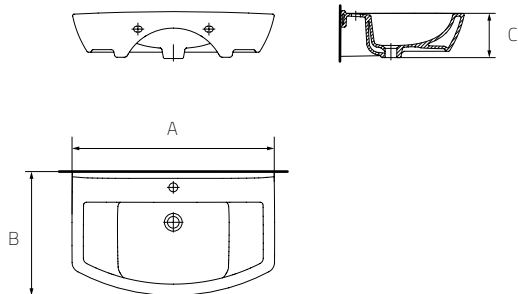

		A (cm)	B (cm)	C (cm)
umywalka OLIMPIA 80 OLIMPIA 80 washbasin	K10-005	81	48,5	16,5

OLIMPIA >

Umywalka
OLIMPIA 60
**OLIMPIA 60
washbasin**
60,5×46,5 cm
Z otworem
na armaturę,
montaż z
postumentem
lub półpostu-
mentem.
With hole for
mixer, assembly
with a pedestal
or semi-pede-
stal .

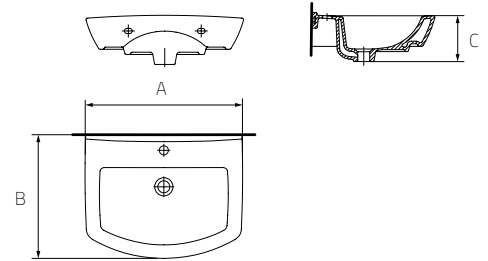

półpostument
OLIMPIA
**OLIMPIA
semi-pedestal**
20x29,5 cm



postument
OLIMPIA
**OLIMPIA
pedestal**
16x16 cm



		A (cm)	B (cm)	C (cm)
umywalka OLIMPIA 50 OLIMPIA 50 washbasin	K10-001	50,5	41	17
umywalka OLIMPIA 55 OLIMPIA 55 washbasin	K10-002	56	44	17,5
umywalka OLIMPIA 60 OLIMPIA 60 washbasin	K10-003	60,5	46,5	17
umywalka OLIMPIA 70 OLIMPIA 70 washbasin	K10-004	70,5	48	17
postument OLIMPIA OLIMPIA pedestal	K10-007	16	16	69
półpostument OLIMPIA OLIMPIA semi-pedestal	K10-006	20	29,5	33

CARINA >

Umywalka
CARINA 60
**CARINA 60
washbasin**
60x41,5 cm
Z otworem na
armaturę, monta-
ż z półpostu-
mentem.
With hole for
mixer, assembly
with a semi-pe-
destal.

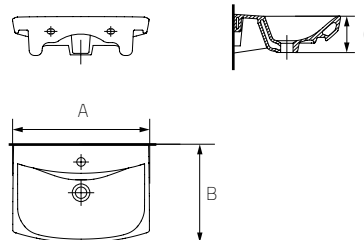

półpostument
CARINA
**CARINA
semi-pedestal**
22x28 cm



		A (cm)	B (cm)	C (cm)
umywalka CARINA 50 CARINA 50 washbasin	K31-004	50	39	15
umywalka CARINA 55 CARINA 55 washbasin	K31-005	55	40	15
umywalka CARINA 60 CARINA 60 washbasin	K31-006	60	41,5	16
umywalka CARINA 70 CARINA 70 washbasin	K31-007	70	43,5	17
półpostument CARINA CARINA semi-pedestal	K31-003	22	28	31,5

CASPIA >

Umywalka
blatowa
CASPIA
SQUARE 60
**CASPIA
SQUARE 60
countertop
washbasin**
59,5x42 cm
Z otworem na
armaturę, mon-
taż na blacie.
With hole for
mixer, assembly
on a countertop.

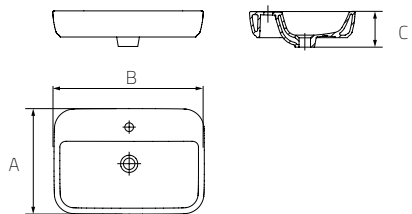

		A (cm)	B (cm)	C (cm)
umywalka CASPIA SQUARE 60	K11-0095	59,5	42	14,5
CASPIA SQUARE 60 washbasin				

CASPIA >

Umywalka
blatowa
CASPIA OVAL 60
**CASPIA OVAL 60
countertop
washbasin**
60x42 cm
Z otworem
na armaturę,
montaż na
blacie.
With hole for
mixer, assembly
on a countertop.

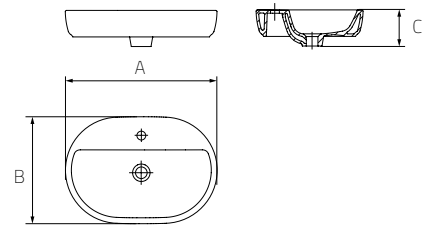

Umywalka
blatowa
CASPIA RING 44
**CASPIA RING 44
countertop
washbasin**
44x44 cm
Z otworem
na armaturę,
montaż na
blacie.
With hole for
mixer, assembly
on a counter-
top..

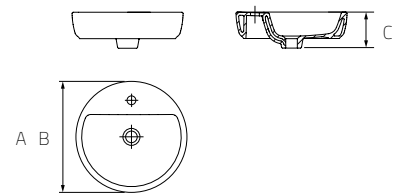

		A (cm)	B (cm)	C (cm)
umywalka CASPIA RING 44	K11-0094	44	44	14,5
CASPIA RING 44 washbasin				
umywalka CASPIA OVAL 60	K11-0099	60	42	15
CASPIA OVAL 60 washbasin				

ONTARIO >

Umywalka
blatowa
ONTARIO 50
**ONTARIO 50
countertop
washbasin**
50×39,5 cm
Z otworem na
armaturę, mon-
taż na blacie.
With hole for
mixer, assembly
on a countertop.

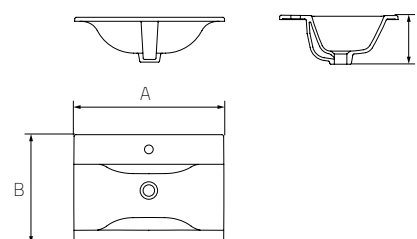

		A (cm)	B (cm)	C (cm)
umywalka ONTARIO 50 ONTARIO 50 washbasin	K669-001	50	39,5	16,5
umywalka ONTARIO 60 ONTARIO 60 washbasin	K669-002	60	45	18

ZURO >

Umywalka konglomeratowa ZURO 60
ZURO 60 conglomerate washbasin
 60x45 cm
 Z otworem na armaturę, montaż na blacie.
 With hole for mixer, assembly on a countertop.

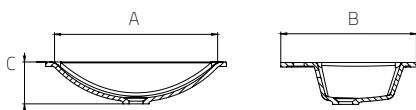

		A (cm)	B (cm)	C (cm)
umywalka ZURO 60 ZURO 60 washbasin	K11-0114	60	45	14
umywalka ZURO 80 ZURO 80 washbasin	K11-0115	80	45	14

AMAO >

Umywalka konglomeratowa AMAO 80
AMAO 80 conglomerate washbasin
 80x45 cm
 Z otworem na armaturę, montaż na blacie.
 With hole for mixer, assembly on a countertop.

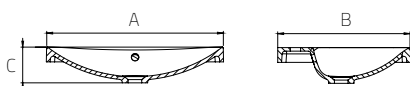

		A (cm)	B (cm)	C (cm)
umywalka AMAO 60 AMAO 60 washbasin	K11-0112	60	45	12
umywalka AMAO 80 AMAO 80 washbasin	K11-0113	80	45	14

CALLA >

Umywalka blatowa CALLA 54
CALLA 54 countertop washbasin
 53,5x41 cm
 Z otworem na armaturę, montaż na blacie.
 With hole for mixer, assembly on a countertop.

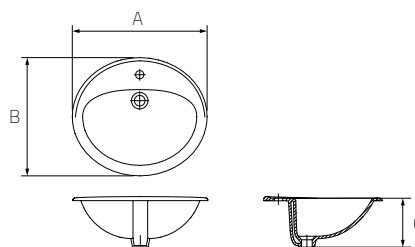

		A (cm)	B (cm)	C (cm)
umywalka CALLA 54 CALLA 54 washbasin	K11-0096	53,5	41	17,5

GAMMA >

umywalka blatowa GAMMA 63
GAMMA 63 countertop washbasin
 63x48 cm
 Z otworem na armaturę, montaż na blacie.
 With hole for mixer, assembly on a countertop.

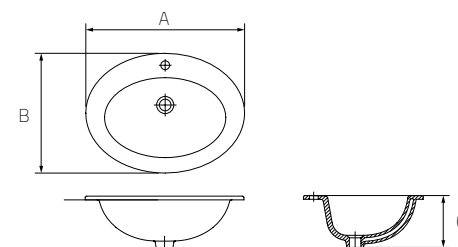

		A (cm)	B (cm)	C (cm)
umywalka GAMMA 63 GAMMA 63 washbasin	K11-0012	63	48	20

ARTECO >

Umywalka
ARTECO 50
ARTECO 50
washbasin
50x43,5cm
Z otworem na
armaturę, mon-
taż do ściany.
With hole for
mixer, assembly
on walls.

NOWOŚĆ/NEW

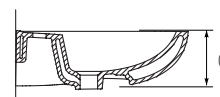
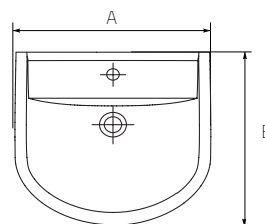

ARTECO >

Umywalka ARTECO 40
ARTECO 40 washbasin
40x29cm
Z otworem na armaturę, montaż do ściany.
With hole for mixer, assembly on walls.

NOWOŚĆ/NEW

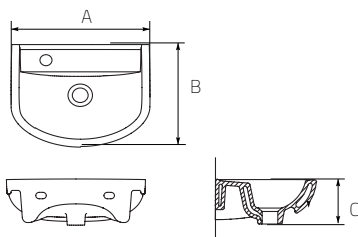

		A (cm)	B (cm)	C (cm)
umywalka ARTECO 40 prawa ARTECO 40 washbasin right	K667-005	40	29	12,5
umywalka ARTECO 40 lewa ARTECO 40 washbasin left	K667-006	40	29	12,5
umywalka ARTECO 50 ARTECO 50 washbasin	K667-007	50	43,5	14,5
umywalka ARTECO 55 ARTECO 55 washbasin	K667-008	55	44	15
umywalka ARTECO 60 ARTECO 60 washbasin	K667-009	60	44	15,5

FACILE >

Umywalka FACILE 60
FACILE 60 washbasin
60x41 cm
Z otworem na armaturę, montaż z półpostumentem lub do ściany.
With hole for mixer, assembly on walls or with a semi-pedestal.

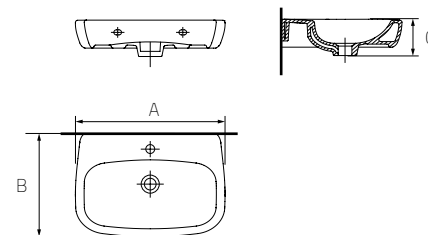

półpostument FACILE
FACILE semi-pedestal
18x29,5 cm



		A (cm)	B (cm)	C (cm)
umywalka FACILE 40 prawa FACILE 40 washbasin right	K30-001-R	40	36	12,5
umywalka FACILE 40 lewa FACILE 40 washbasin left	K30-001-L	40	36	12,5
umywalka FACILE 50 FACILE 50 washbasin	K30-002	50	39,5	13,5
umywalka FACILE 55 FACILE 55 washbasin	K30-003	55,4	39,7	14
umywalka FACILE 60 FACILE 60 washbasin	K30-004	60	41	14,5
półpostument FACILE FACILE semi-pedestal	K30-011	18	29,5	28

STANDARD

**CERAMIKA
SANITARNA**
UMYWALKI
SANITARY
CERAMICS
WASHBASINS

IRYDA
 Umywalka IRYDA 70
IRYDA 70 washbasin
 70,5x48,5 cm
 Z otworem na armaturę, montaż do ściany.
 With hole for mixer, assembly on walls.

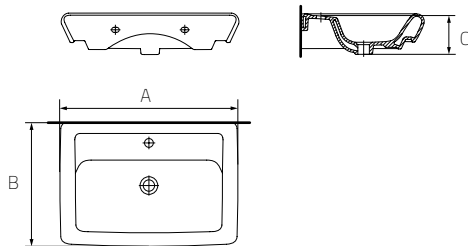

		A (cm)	B (cm)	C (cm)
umywalka IRYDA 70 IRYDA 70 washbasin	K02-018	70,5	48,5	16,5
umywalka IRYDA 80 IRYDA 80 washbasin	K02-019	80,5	48	17

IRYDA
 Umywalka IRYDA 60
IRYDA 60 washbasin
 60,5x47,5 cm
 Z otworem na armaturę, montaż z postumentem lub półpostumentem.
 With hole for mixer, assembly with a pedestal or semi-pedestal.

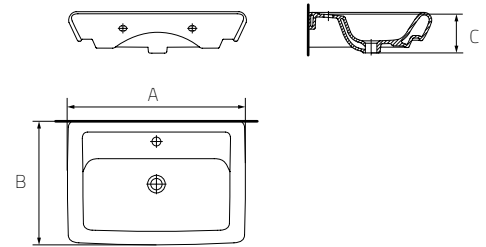

półpostument IRYDA
IRYDA semi-pedestal
 19,5x32 cm



postument IRYDA
IRYDA pedestal
 16x17,5 cm



		A (cm)	B (cm)	C (cm)
umywalka IRYDA 50 IRYDA 50 washbasin	K02-002	50,5	47,5	16
umywalka IRYDA 55 IRYDA 55 washbasin	K02-004	55,5	47,5	16,5
umywalka IRYDA 60 IRYDA 60 washbasin	K02-006	60,5	47,5	16,5
postument IRYDA IRYDA pedestal	K02-007	16	17,5	69
półpostument IRYDA IRYDA semi-pedestal	K02-008	19,5	32	29

**CERAMIKA
SANITARNA
UMYWALKI
SANITARY
CERAMICS
WASHBASINS**

PRESIDENT >

Umywalka
PRESIDENT 50
washbasin
50x43,5 cm
Z otworem
na armaturę,
montaż
z postumentem
lub półpostu-
mentem.
With hole for
mixer, assembly
with a pedestal
or semi-pede-
stal.

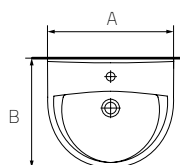
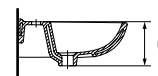
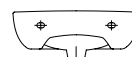

półpostument
PRESIDENT
**PRESIDENT
semi-pedestal**
27x27,5 cm



postument
PRESIDENT
**PRESIDENT
pedestal**
17x17 cm



		A (cm)	B (cm)	C (cm)
umywalka PRESIDENT 45 z otworem na armaturę PRESIDENT 45 washbasin with hole for mixer	K08-002	44,5	35	16
umywalka PRESIDENT 45 bez otworu na armaturę PRESIDENT 45 washbasin without hole for mixer	K08-001	44,5	35	16
umywalka PRESIDENT 50 z otworem na armaturę PRESIDENT 50 washbasin with hole for mixer	K08-004	50	43,5	17,5
umywalka PRESIDENT 50 bez otworu na armaturę PRESIDENT 50 washbasin with hole for mixer	K08-003	50	43,5	17,5
umywalka PRESIDENT 55 z otworem na armaturę PRESIDENT 55 washbasin with hole for mixer	K08-007	55	45,5	19
umywalka PRESIDENT 55 bez otworu na armaturę PRESIDENT 55 washbasin without hole for mixer	K08-005	55	45,5	19
umywalka PRESIDENT 60 z otworem na armaturę PRESIDENT 60 washbasin with hole for mixer	K08-010	60,5	48,5	19
umywalka PRESIDENT 60 bez otworu na armaturę PRESIDENT 60 washbasin without hole for mixer	K08-009	60,5	48,5	19
postument PRESIDENT PRESIDENT pedestal	K08-011	17	17	64
półpostument PRESIDENT PRESIDENT semi-pedestal	K08-012	27	27,5	33

NANO >

Umywalka asymetryczna NANO 50 prawa/lewa
NANO 50 washbasin asymmetric right/left
 49,5x34,5 cm
 Z otworem na armaturę, montaż do ściany.
 With hole for mixer, assembly on walls.

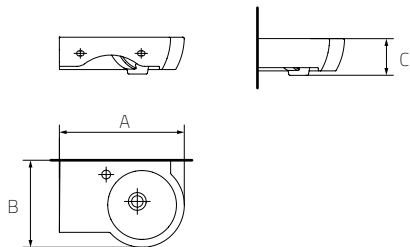

Umywalka NANO 50 prawa/lewa
NANO 50 washbasin right/left
 52x38 cm
 Z otworem na armaturę, montaż do ściany.
 With hole for mixer, assembly on walls.

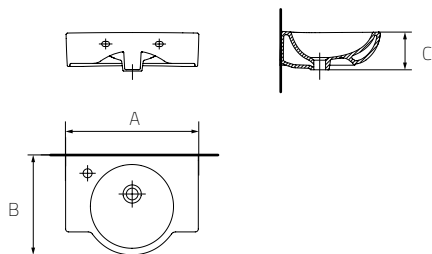

		A (cm)	B (cm)	C (cm)
umywalka asymetryczna NANO 50 prawa NANO 50 washbasin asymmetric right	K19-005	49,5	34,5	14,5
umywalka asymetryczna NANO 50 lewa NANO 50 washbasin asymmetric left	K19-006	49,5	34,5	14,5
umywalka NANO 50 prawa NANO 50 washbasin right	K19-003	52	38	15
umywalka NANO 50 lewa NANO 50 washbasin left	K19-004	52	38	15

NANO >

Umywalka NANO 40 prawa/lewa
NANO 40 washbasin right/left
 40X38,5 cm
 Z otworem na armaturę, montaż z syfonem ozdobnym lub na blacie.
 With hole for mixer. Assembly with a decorative siphon or on a countertop.

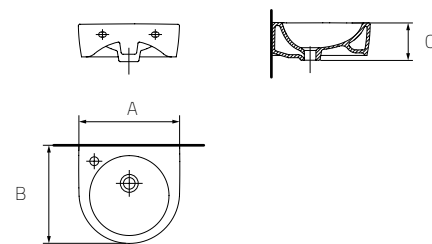

Umywalka NANO 55 prawa/lewa
NANO 55 washbasin right/left
 55x42 cm
 Z otworem na armaturę, montaż do ściany.
 With hole for mixer, assembly on walls.

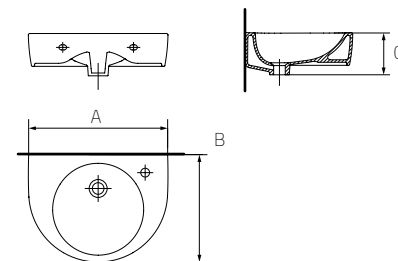

		A (cm)	B (cm)	C (cm)
umywalka NANO 40 prawa NANO 40 washbasin right	K19-001	40	38,5	15
umywalka NANO 40 lewa NANO 40 washbasin left	K19-002	40	38,5	15
umywalka NANO 55 PRAWA NANO 55 washbasin right	K19-007	55	42	17
umywalka NANO 55 lewa NANO 55 washbasin left	K19-008	55	42	17

SIGMA >

Umywalka narożna
SIGMA 30
**SIGMA 30
corner
washbasin**
36×36 cm
Z otworem na
armaturę.
With hole for
mixer.

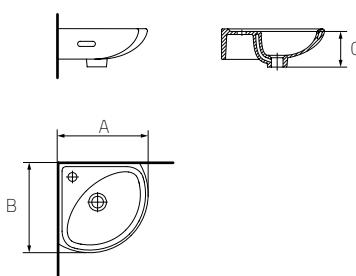

		A (cm)	B (cm)	C (cm)
umywalka SIGMA 30 SIGMA 30 washbasin	K11-0013	36	36	15

TETA >

Umywalka narożna
TETA 40
**TETA 40
corner
washbasin**
43×43 cm
Z otworem na
armaturę.
With hole for
mixer.

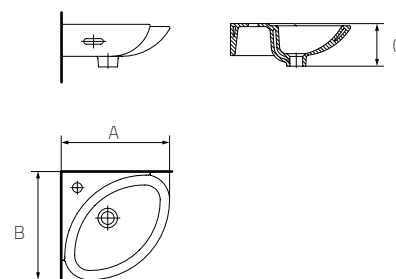

		A (cm)	B (cm)	C (cm)
umywalka TETA 40 TETA 40 washbasin	K11-0016	43	43	16

EKO

Umywalka
EKO 35
EKO 35
washbasin
35x30,5cm
Z otworem na
armaturę.
With hole for
mixer.

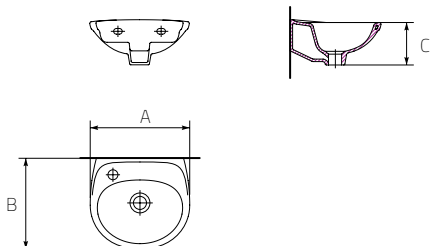

		A (cm)	B (cm)	C (cm)
umywalka EKO 35 prawa EKO 35 washbasin right	K07-002-P	35	30,5	15
umywalka EKO 35 lewa EKO 35 washbasin left	K07-002-L	35	30,5	15

PARVA

Umywalka
PARVA 40
prawa/lewa
PARVA 40
washbasin
right/left
40x32 cm
Z otworem
na armaturę,
montaż z
postumentem
lub półpostu-
mentem.
With hole for
mixer, assembly
with a pedestal
or semi-pede-
stal.

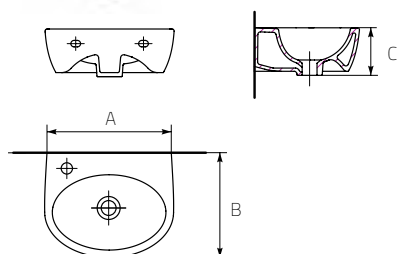

		A (cm)	B (cm)	C (cm)
umywalka PARVA 40 prawa PARVA 40 washbasin right	K27-009-P	40	32	14,5
umywalka PARVA 40 lewa PARVA 40 washbasin left	K27-009-L	40	32	14,5

PARVA

Umywalka
PARVA 50
PARVA 50
washbasin
50x40 cm
Z otworem
na armaturę,
montaż z
postumentem
lub półpostu-
mentem.
With hole for
mixer, assembly
with a pedestal
or semi-pede-
stal.

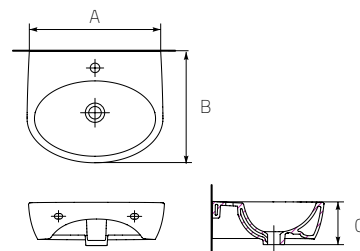

półpostument
PARVA
PARVA
semi-pedestal
30,5x19 cm



postument
PARVA
PARVA
pedestal
18x18 cm



		A (cm)	B (cm)	C (cm)
umywalka PARVA 50 PARVA 50 washbasin	K27-030	50	40	15,5
umywalka PARVA 55 PARVA 55 washbasin	K27-029	55	42,5	16
umywalka PARVA 60 PARVA 60 washbasin	K27-031	60	45	16,5
postument PARVA PARVA pedestal	K27-026	18	18	71,5
półpostument PARVA PARVA semi-pedestal	K27-008	19	32,5	30,5

STAN
DARD

**CERAMIKA
SANITARNA**
UMYWALKI
SANITARY
CERAMICS
WASHBASINS

CERSANIA >

Umywalka
CERSANIA
NEW 60
**CERSANIA
NEW 60
washbasin**
60,5×41,5 cm
Z otworem na
armaturę, mon-
taż do ściany.
With hole for
mixer, assembly
on walls.

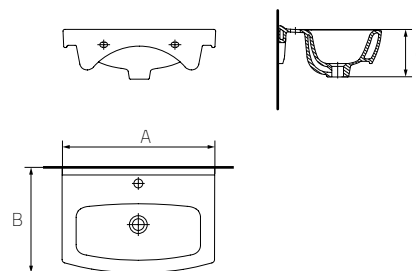

		A (cm)	B (cm)	C (cm)
umywalka CERSANIA NEW 40 CERSANIA NEW 40 washbasin	K11-0050	40	33	15
umywalka CERSANIA NEW 50 CERSANIA NEW 50 washbasin	K11-0044	51	38,5	16,5
umywalka CERSANIA NEW 55 CERSANIA NEW 55 washbasin	K11-0045	55,5	39	17,5
umywalka CERSANIA NEW 60 CERSANIA NEW 60 washbasin	K11-0046	60,5	41,5	18,5

CARLA >

Umywalka
CARLA 60
**CARLA 60
washbasin**
61×45,5 cm
Z otworem na
armaturę, mon-
taż do ściany.
With hole for
mixer, assembly
on walls.

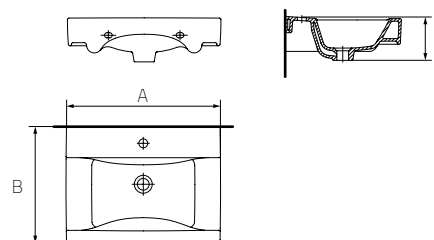

		A (cm)	B (cm)	C (cm)
umywalka CARLA 60 CARLA 60 washbasin	K11-0052	61	45,5	17
umywalka CARLA 90 CARLA 90 washbasin	K11-0039	91,7	49	19,5

ROMA >

Umywalka
ROMA 80
ROMA 80
washbasin
81,3×48,5 cm
Z otworem na
armaturę, mon-
taż do ściany.
With hole for
mixer, assembly
on walls.

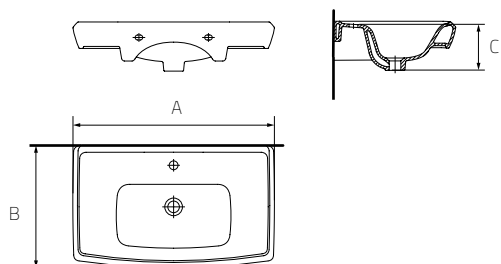

		A (cm)	B (cm)	C (cm)
umywalka ROMA 80	K11-0004	81,3	48,5	18

OMEGA >

Umywalka
OMEGA 65
OMEGA 65
washbasin
65,5×44,5 cm
Z otworem na
armaturę, mon-
taż do ściany.
With hole for
mixer, assembly
on walls.

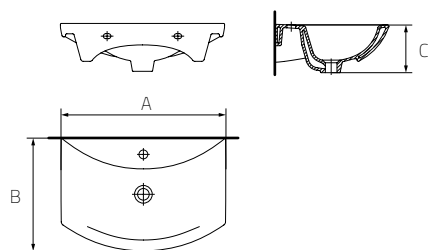

		A (cm)	B (cm)	C (cm)
umywalka OMEGA 65	K11-0003	65,5	44,5	18,5
umywalka OMEGA 80	K11-0011	81,8	46,5	19

LIBRA >

Umywalka
LIBRA 60
LIBRA 60
washbasin
60,5×46 cm
Z otworem na
armaturę, mon-
taż do ściany.
With hole for
mixer, assembly
on walls.

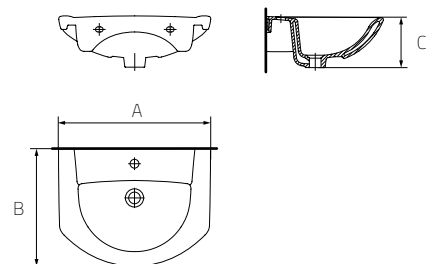

Umywalka
LIBRA 80
LIBRA 80
washbasin
81,5×46,5 cm
Z otworem na
armaturę, mon-
taż do ściany.
With hole for
mixer, assembly
on walls.

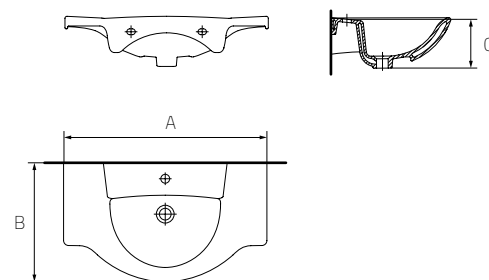

		A (cm)	B (cm)	C (cm)
umywalka LIBRA 60	K04-008	60,5	46	19,5
umywalka LIBRA 80	K04-012	81,5	46,5	19,5



CERAMIKA
SANITARNA
MISKI ZAWIESZANE
SANITARY
CERAMICS
WALL HUNG
BOWLS

N^o2

**CERAMIKA
SANITARNA**
MISKI
ZAWIESZANE
SANITARY
CERAMICS
WALL HUNG
BOWLS



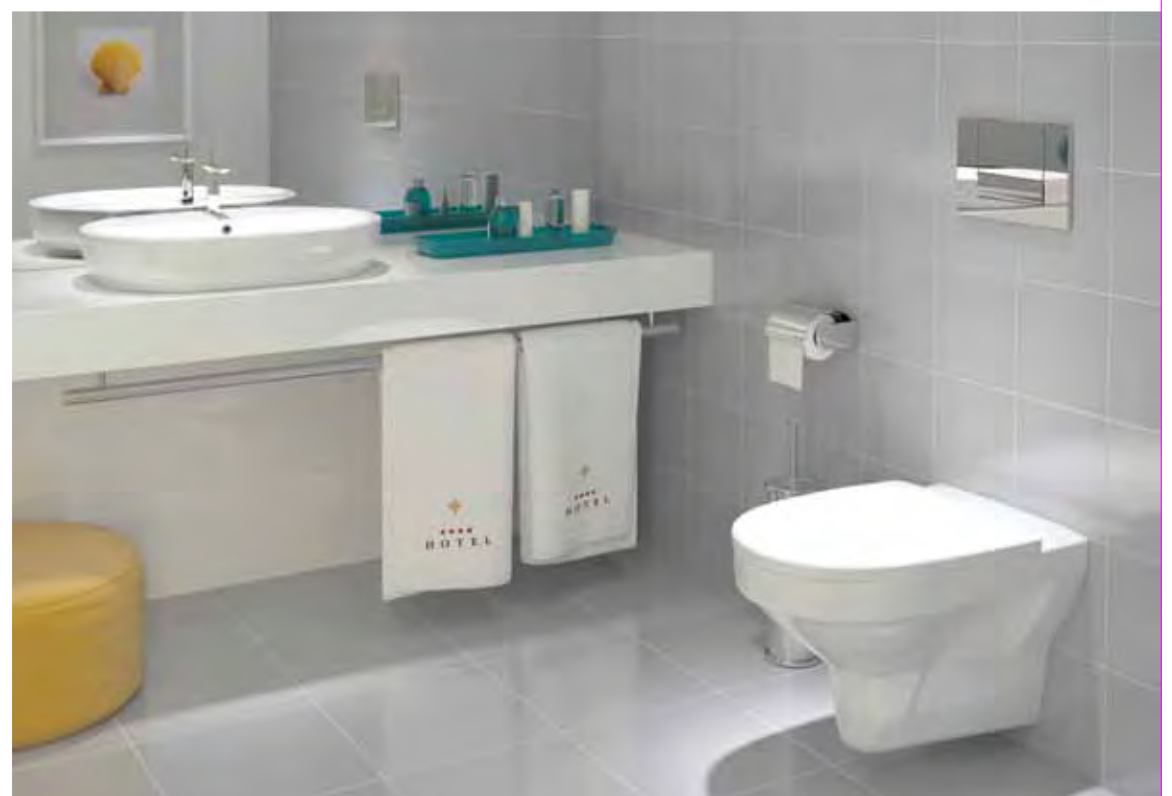

Ceramika sanitarna: umywalka Caspia oval, miska zawieszana Olimpia
Płytki: Inwencja white, grey
Sanitary ceramics: Caspia oval washbasin, Olimpia wall hung bowl
Ceramic tiles: Inwencja white, grey

INNOVATION !

IN CERSANIT'S OFFER

CARINA >

Miska zawieszana CARINA
CLEAN ON
CARINA CLEAN ON wall-hung bowl

35x52,5 cm
Bez obrzeża
No rim

NOWOŚĆ / NEW

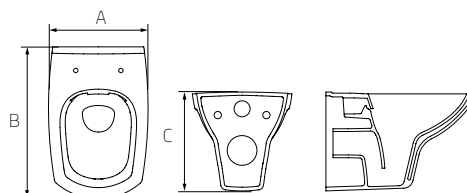

		A (cm)	B (cm)	C (cm)
miska zawieszana CARINA CLEAN ON CARINA CLEAN ON wall-hung bowl	K31-029	35	52,5	35,5
deska CARINA duroplastowa, CARINA duroplast toilet seat	K98-0068	-	-	-
deska CARINA duroplastowa, wolno opadająca, łatwo wypij- najaca się CARINA duroplast slow-close, easy off toilet seat	K98-0069	-	-	-

CARINA >
Miska
zawieszana
CARINA
CARINA
wall hung bowl
35x53 cm

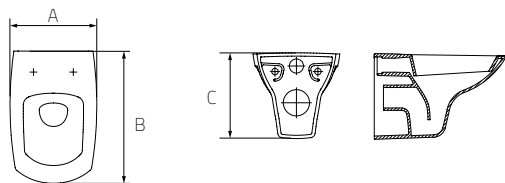

		A (cm)	B (cm)	C (cm)
miska zawieszana CARINA CARINA wall hung bowl	K31-002	35	53	35
deska duroplastowa, antybakteryjna CARINA CARINA duroplast antibac- terial toilet seat	K98-0068	-	-	-
deska wolno opadająca, duroplastowa, antybakteryjna CARINA CARINA duroplast anti- bacterial slow-close toilet seat	K98-0069	-	-	-

CleanPro

niewidzialna powłoka,
ograniczająca osadzanie się ka-
mienia i brudu / **invisible coating,**
limiting deposition of both scale
and dirt

EASY >
Miska
zawieszana
EASY
EASY
wall-hung bowl
36x52cm

NOWOŚĆ / NEW



deska duropla-
stowa EASY
EASY
duroplast toilet
seat

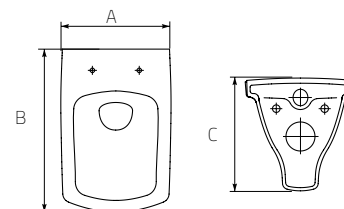

		A (cm)	B (cm)	C (cm)
miska zawieszana EASY EASY wall-hung bowl	K102-003	35,5	51,5	37
deska duroplastowa wolno opadająca, łatwo wypinająca się EASY EASY duroplast slow-clo- se, easy off toilet seat	K98-0089	-	-	-
deska duroplastowa EASY EASY duroplast toilet seat	K98-0090	-	-	-

**PRE
STIGE**

**CERAMIKA
SANITARNA**
MISKI
ZAWIESZANE
SANITARY
CERAMICS
WALL HUNG
BOWLS

BILBAO >

Miska
zawieszana
BILBAO
BILBAO
wall hung bowl
40x57 cm

PERFECT
CLEAN

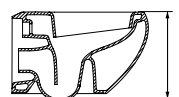
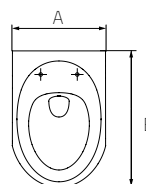

		A (cm)	B (cm)	C (cm)
miska zawieszana BILBAO BILBAO wall hung bowl	OK-03-002	40	57	37
deska BILBAO antybakteryjna wolnoopadająca łatwo wypina- jąca się BILBAO duroplast antibacterial slow-close and easy-off toilet seat	OK98-0003	-	-	-

KIOTO >
Miska
zawieszana
KIOTO
**KIOTO
wall hung bowl**
39 x 57,5 cm

**PERFECT
CLEAN**

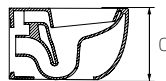
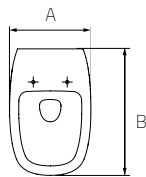

		A (cm)	B (cm)	C (cm)
miska zawieszana KIOTO KIOTO wall hung bowl	OK-02-006	39	57,5	35
deska Kioto antybakteryjna wolnoopadająca KIOTO duroplast antibacterial slow-close and easy-off toilet seat	OK-98-0002	-	-	-

MALMO >
Miska
zawieszana
MALMO
**MALMO wall
hung bowl**
36,5x58 cm

**PERFECT
CLEAN**

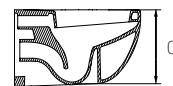
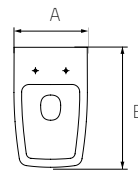

Miska zawieszana MALMO
**MALMO
wall hung bowl**
kasztan
chestnut

Miska zawieszana MALMO
**MALMO
wall hung bowl**
wenge
wenge

		A (cm)	B (cm)	C (cm)
miska zawieszana MALMO MALMO wall hung bowl	OK-01-005	36,5	58	36
deska MALMO duroplastowa antybakteryjna wolnoopadająca MALMO duroplast antibacterial slow- close toilet seat	OK-98-0001	-	-	-

**PRE
STIGE**

**CERAMIKA
SANITARNA**
MISKI
ZAWIESZANE
SANITARY
CERAMICS
WALL HUNG
BOWLS

PURE >

Miska
zawieszana
PURE
PURE
wall hung bowl
35,5x54,5 cm

PURE SILVER
PROTECT

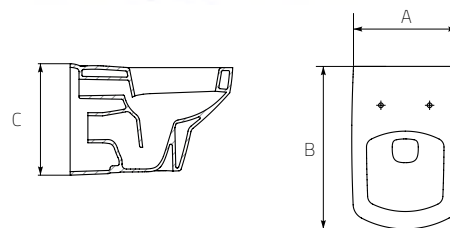

		A (cm)	B (cm)	C (cm)
miska zawieszana PURE PURE wall hung bowl	K101-001 -BOX	35,5	54,5	39
deska duroplastowa, antybakteryjna, łatwo wypinająca się PURE PURE duroplast antibac- terial easy-off toilet seat	K98-0082	-	-	-
deska duroplastowa, antybakteryjna, wolno opadająca, łatwo wypi- nająca się PURE PURE duroplast anti- bacterial slow-close and easy-off toilet seat	K98-0083	-	-	-

OLIMPIA >

Miska
zawieszana
OLIMPIA
**OLIMPIA
wall hung bowl**
37x54 cm

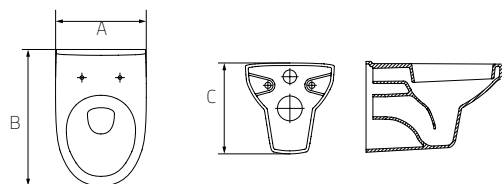

		A (cm)	B (cm)	C (cm)
miska zawieszana OLIMPIA OLIMPIA wall hung bowl	K10-008	37	54	38
deska duroplastowa, antybakteryjna OLIMPIA OLIMPIA duroplast antibacterial toilet seat	K98-0010	-	-	-
deska wolno opadająca, duroplastowa, antybakteryjna OLIMPIA OLIMPIA duroplast antibacterial slow-close toilet seat	K98-0011	-	-	-

COLOUR >

Miska
zawieszana
COLOUR
**COLOUR
wall-hung bowl**
36x52 cm

NOWOŚĆ/NEW



deska duroplastowa COLOUR
biała
**COLOUR
duroplast toilet
seat white**

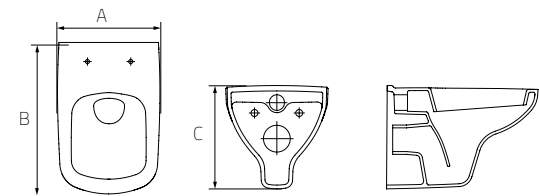

		A (cm)	B (cm)	C (cm)
miska zawieszana COLOUR COLOUR wall-hung bowl	K103-003	36	52	37
deska COLOUR duroplastowa, COLOUR duroplast toilet seat	K98-0091	-	-	-
deska COLOUR duroplastowa, wolno opadająca, łatwo wypinająca się biała COLOUR duroplast slow-close, easy off toilet seat white	K98-0092	-	-	-
deska COLOUR duroplastowa, wolno opadająca, łatwo wypinająca się szara COLOUR duroplast slow-close, easy off toilet seat grey	K98-0093	-	-	-

PRE
STIGE

INNOVATION !

IN CERSANIT'S OFFER

PARVA >

Miska
zawieszana
PARVA CLEAN
ON
**PARVA CLEAN
ON wall-hung
bowl**
34,5 x51cm
Bez obrzeża
No rim

NOWOŚĆ/NEW

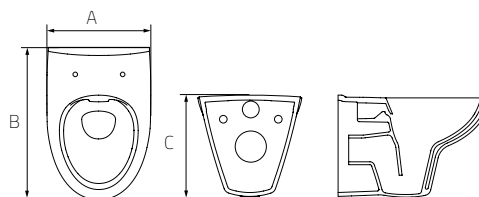

		A (cm)	B (cm)	C (cm)
miska zawieszana PARVA PARVA wall-hung bowl	K27-040	34,5	51	36,5
deska duroplastowa PARVA PARVA duroplast toilet seat	K98-0052	-	-	-
deska duroplastowa, wolno- opadająca, łatwo wypinająca się PARVA PARVA duroplast slow-close, easy off toilet seat	K98-0053	-	-	-

ARTECO >

Miska
zawieszana
ARTECO
ARTECO
wall-hung bowl
36×51,5 cm

NOWOŚĆ/NEW



deska duroplastowa ARTECO
ARTECO
duroplast toilet seat

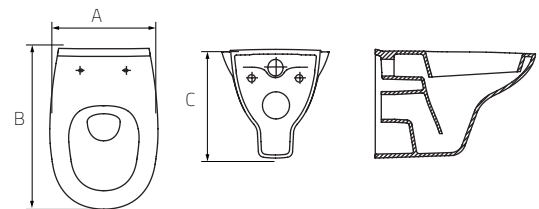

		A (cm)	B (cm)	C (cm)
miska zawieszana ARTECO ARTECO wall-hung bowl	K667-010	36	51,5	37
deska ARTECO duroplastowa, ARTECO duroplast toilet seat	K667-002	-	-	-
deska ARTECO duroplastowa, wolno opadająca, łatwo wypinająca się ARTECO duroplast slow-close, easy off toilet seat	K667-001	-	-	-
deska ARTECO polipropylenowa, antybakteryjna ARTECO polypropylene antibacterial toilet seat	K667-011	-	-	-

**CERAMIKA
SANITARNA**
MISKI
ZAWIESZANE
SANITARY
CERAMICS
WALL HUNG
BOWLS

PARVA >

Miska
zawieszana
PARVA
PARVA
wall hung bowl
35x52,5cm

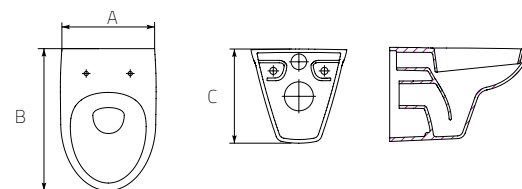

		A (cm)	B (cm)	C (cm)
miska zawieszana z deską duroplastową PARVA PARVA wall hung bowl with duroplast toilet seat	K27-007	35	52,5	35
miska zawieszana z deską duroplastową wolnoopadającą PARVA PARVA wall hung bowl with duroplast slow-close toilet seat	K27-025	35	52,5	35

IRYDA

Miska
zawieszana
IRYDA
**IRYDA wall
hung bowl**
36x54cm

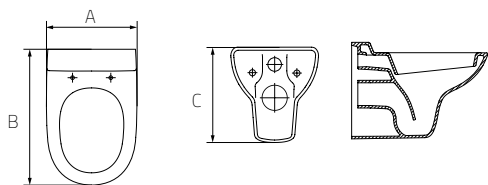

		A (cm)	B (cm)	C (cm)
miska zawieszana IRYDA IRYDA wall hung bowl	K02-015	36	54	39,5
deska duroplastowa, anty- bakteryjna IRYDA IRYDA duroplast antibacterial toilet seat	K98-0012	-	-	-

DELFI

Miska
zawieszana
DELFI
**DELFI
wall hung bowl**
36x52 cm

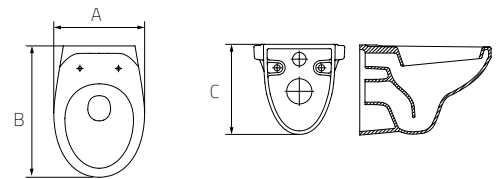

		A (cm)	B (cm)	C (cm)
miska zawieszana DELFI DELFI wall hung bowl	K11-0021	36	52	37,5
deska DELFI duroplastowa antybakteryjna DELFI duroplast antibacterial toilet seat	K98-0001	-	-	-
deska DELFI polipropylenowa antybakteryjna DELFI polypropylene antibac- terial toilet seat	K98-0039	-	-	-
deska polipropylenowa, wolno opadająca, antybakteryjna DELFI polypropylene antibac- terial slow-close toilet seat	K98-0073	-	-	-

**CERAMIKA
SANITARNA**
MISKI
ZAWIESZANE
SANITARY
CERAMICS
WALL HUNG
BOWLS

NANO >

Miska
zawieszana
NANO
**NANO
wall hung bowl**
36,5x48cm

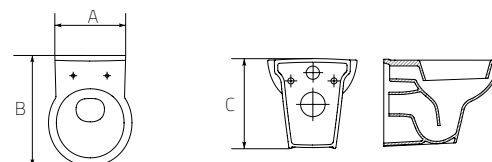

		A (cm)	B (cm)	C (cm)
miska zawieszana NANO NANO wall hung bowl	K19-009	36,5	480	36.5
deska duroplastowa, antybakteryjna, wolno opadająca, łatwo wypinająca się NANO NANO duroplast antibacterial slow-close and easy-off toilet seat	K98-0049	-	-	-
deska duroplastowa, antybakteryjna, łatwo wypinająca się NANO NANO duroplast antibacterial and easy-off toilet	K98-0048	-	-	-

PRESIDENT >

Miska
zawieszana
PRESIDENT
PRESIDENT
wall hung bowl
35,5x52,5 cm

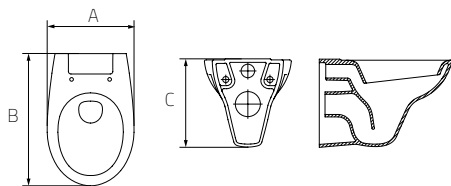

		A (cm)	B (cm)	C (cm)
miska zawieszana PRESIDENT PRESIDENT wall hung bowl	K08-027	35,5	52,5	36,5
deska PRESIDENT duroplastowa antybakteryjna PRESIDENT duroplast antibacterial toilet seat	K98-0021	-	-	-
deska PRESIDENT polipropylenowa, antybakteryjna PRESIDENT polypropylene antibacterial toilet seat	K98-0022	-	-	-

FACILE >

Miska
zawieszana
FACILE
FACILE
wall hung bowl
31,5x52,5cm

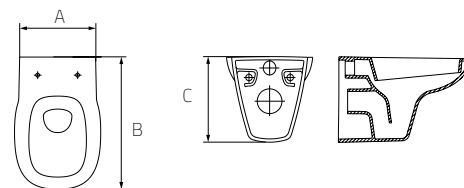

		A (cm)	B (cm)	C (cm)
miska zawieszana FACILE FACILE wall hung bowl	K30-010	31,5	52,5	36,5
deska duroplastowa, antybakteryjna FACILE FACILE duroplast antibacterial toilet seat	K98-0066	-	-	-
deska wolno opadająca, duroplastowa, antybakteryjna FACILE FACILE duroplast antibacterial slow-close toilet seat	K98-0067	-	-	-



CERAMIKA
SANITARNA
WC KOMPAKTY
SANITARY
CERAMICS
WC COMPACTS

N^o3

**CERAMIKA
SANITARNA**
WC KOMPAKTY
SANITARY
CERAMICS
WC COMPACTS





Ceramika sanitarna: seria Olimpia
Sanitary ceramics: Olimpia



INNOVATION !

IN CERSANIT'S OFFER

CARINA >

WC kompakt
CARINA CLEAN
ON

**CARINA CLEAN
ON**

WC compact

35x63cm

Bez obrzeża,
doprowadzenie
wody z boku
(010), doprowa-
dzenie wody z
dołu (011).

No rim, side
water inlet (010)
bottom water
inlet (011)

NOWOŚĆ / NEW

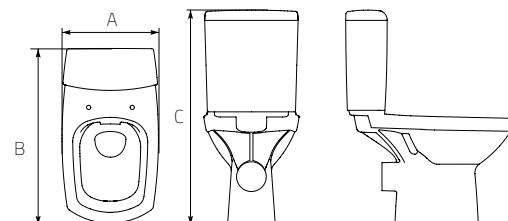

		A (cm)	B (cm)	C (cm)
WC kompakt CARINA CLEAN ON CARINA CLEAN ON WC compact	K31-030 (011) K31-031 (010)	35	63	81
deska CARINA duroplastowa, CARINA duroplast toilet seat	K98-0068	-	-	-
deska CARINA duroplastowa, wolno opadająca, łatwo wypi- nająca się CARINA duroplast slow-close, easy off toilet seat	K98-0069	-	-	-

CARINA >

WC kompakt
CARINA
CARINA
WC compact
35,5x63 cm
Doprowadzenie
wody z boku
(010) lub z dołu
(011).
Funkcja 3/6 l.
Universal bowl
3/6 function
Side water inlet
(010) or bottom
water inlet
(011).

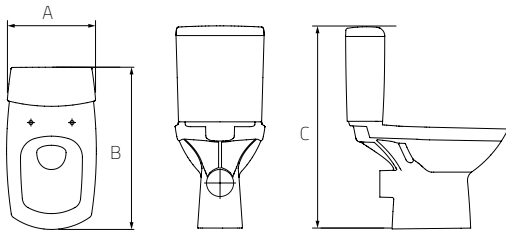

		A (cm)	B (cm)	C (cm)
WC Kompakt CARINA 011 z deską duroplastową, antybakteryjną CARINA 011 WC compact set with duroplast antibacterial toilet seat	K31-011	34,5	63	81
WC Kompakt CARINA 011 z deską duroplastową, wolno opadającą CARINA 011 WC compact set duroplast slow-close toilet seat	K31-012	34,5	63	81
WC Kompakt CARINA 010 z deską duroplastową, antybakteryjną CARINA 010 WC compact set duroplast antibacterial toilet seat	K31-013	34,5	63	81
WC Kompakt CARINA 010 z deską duroplastową, wolno opadającą CARINA 010 WC compact set duroplast slow-close toilet seat	K31-014	34,5	63	81

CleanPro

niewidzialna powłoka,
ograniczająca osadzanie się ka-
mienia i brudu/ **invisible coating,**
limiting deposition of both scale
and dirt

EASY >

WC kompakt
EASY
EASY
WC compact
36x63 cm
Odpyw uniwer-
salny, dopro-
wadzenie wody
z boku (010),
doprowadzenie
wody z dołu
(011).
Universal
outflow, side
water inlet (010)
bottom water
inlet (011)



NOWOŚĆ / NEW

deska duropla-
stowa EASY
EASY
duroplast toilet
seat

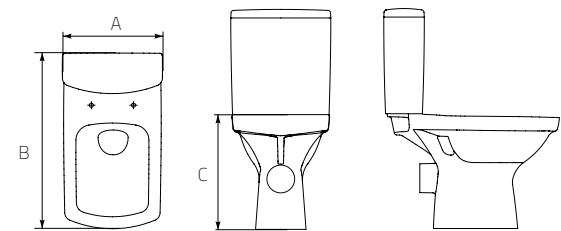

		A (cm)	B (cm)	C (cm)
WC kompakt EASY EASY WC compact	K102-009 (010) K102-010 (011)	36	63	40
deska duroplastowa wolno- opadająca, łatwo wypinająca się EASY EASY duroplast slow-close, easy off toilet seat	K98-0089	-	-	-
deska duroplastowa EASY EASY duroplast toilet seat	K98-0090	-	-	-

**PRE
STIGE**

PURE >

WC kompakt
PURE
PURE
WC compact
36,5x63,5 cm
Odpyw uniwersalny.
Funkcja 3/6 l.
Doprowadzenie wody z dołu (011).
universal out-flow
3/6 function
Side bottom water inlet (011).

PURE ANTIBACTERIAL PROTECT

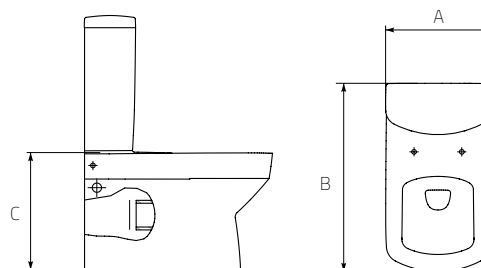

		A (cm)	B (cm)	C (cm)
miska kompaktowa PURE PURE compact bowl	K101-002 -BOX	36,5	63,5	42
zbiornik PURE PURE 3/6 water tank PURE	K101-012 -BOX	36,5	15,5	45,5
deska duroplastowa, antybakteryjna, łatwo wypinająca się PURE PURE duroplast antibacterial and easy-off toilet seat	K98-0082	-	-	-
deska duroplastowa, antybakteryjna, wolno opadająca, łatwo wypinająca się PURE PURE duroplast antibacterial slow-close and easy-off toilet seat	K98-0083	-	-	-

OLIMPIA >

WC kompakt
OLIMPIA
**OLIMPIA
WC compact**
36,5x64,5 cm
Odptyw uniwersalny.
Funkcja 3/6 l.
Doprowadzenie wody z boku (010) lub z dołu (011).
Universal outflow
3/6 function
Side water inlet (010) or bottom water inlet (011).

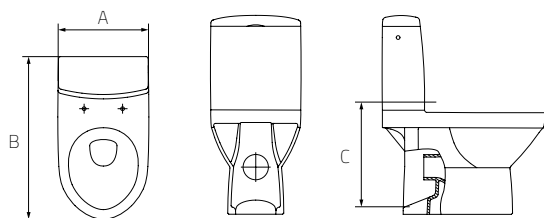

		A (cm)	B (cm)	C (cm)
miska kompaktowa OLIMPIA OLIMPIA compact bowl	K10-011	36,5	64,5	41
zbiornik OLIMPIA 010 OLIMPIA 010 water tank	K101-012	36,5	-	38
zbiornik OLIMPIA 011 OLIMPIA 011 water tank	K101-013	36,5	-	38
deska duroplastowa, antybakteryjna OLIMPIA OLIMPIA duroplast antibacterial toilet seat	K98-0010	-	-	-
deska wolno opadająca, duroplastowa, antybakteryjna OLIMPIA OLIMPIA duroplast antibacterial slow-close toilet seat	K98-0011	-	-	-

COLOUR >

WC kompakt
COLOUR
**COLOUR
WC compact**
36x64,5 cm
Odptyw uniwersalny, doprowadzenie wody z boku (010), doprowadzenie wody z dołu (011).
Universal outflow, side water inlet (010) bottom water inlet (011)



NOWOŚĆ/NEW

deska duroplastowa COLOUR
szara
**COLOUR
duroplast toilet seat grey**

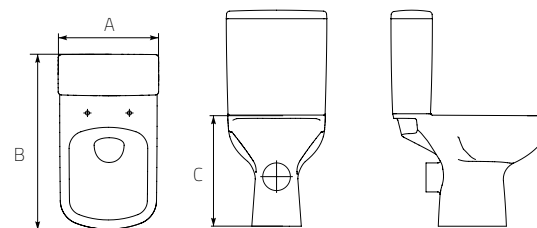

		A (cm)	B (cm)	C (cm)
WC kompakt COLOUR COLOUR WC compact	K103-012 (011) K103-013 (010)	36	64,5	40,5
deska COLOUR duroplastowa, COLOUR duroplast toilet seat	K98-0091	-	-	-
deska COLOUR duroplastowa, wolno opadająca, łatwo wypinająca się biała COLOUR duroplast slow-close, easy off toilet seat white	K98-0092	-	-	-
deska COLOUR duroplastowa, wolno opadająca, łatwo wypinająca się szara COLOUR duroplast slow-close, easy off toilet seat grey	K98-0093	-	-	-

**PRE
STIGE**

INNOVATION !

IN CERSANIT'S OFFER

PARVA >

WC kompakt
PARVA CLEAN
ON

PARVA CLEAN ON WC compact

36x61 cm
Bez obrzeża,
doprowadzenie
wody z boku
(010), doprowa-
dzenie wody z
dołu (011).

No rim, side
water inlet (010)
bottom water
inlet (011)

NOWOŚĆ/NEW

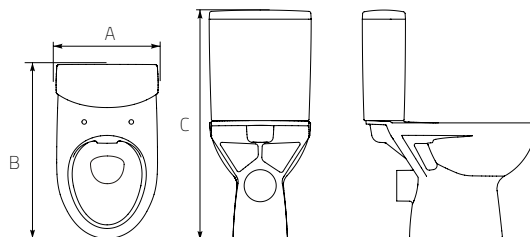

		A (cm)	B (cm)	C (cm)
WC kompakt PARVA CLEAN ON PARVA CLEAN ON WC compact	K27-038 (011) K27-039 (010)	36	61	77,5
deska duroplastowa PARVA PARVA duroplast toilet seat	K98-0052	-	-	-
deska duroplastowa, wolno- opadająca, łatwo wypinająca się PARVA PARVA duroplast slow-close, easy off toilet seat	K98-0053	-	-	-

ARTECA >

WC kompakt
ARTECA
ARTECA
WC compact
35,5×63,5 cm
Odpływ uniwersalny, doprowadzenie wody z boku (010), doprowadzenie wody z dołu (011).
Universal outflow, side water inlet (010) bottom water inlet (011)

NOWOŚĆ/NEW



deska duroplastowa ARTECO
ARTECO
duroplast toilet seat

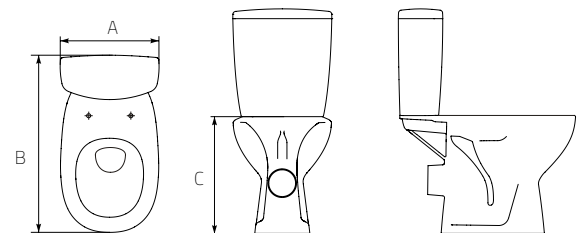

ARTECO >

WC kompakt
ARTECO
ARTECO
WC compact
35,5×63,5 cm
Odpływ uniwersalny, doprowadzenie wody z boku (010), doprowadzenie wody z dołu (011).
Universal outflow, side water inlet (010) bottom water inlet (011)

NOWOŚĆ/NEW



		A (cm)	B (cm)	C (cm)
WC kompakt ARTECO ARTECO WC compact	K667-003 (010)	35,5	63,5	74
	K667-004 (011)			
WC kompakt ARTECA ARTECA WC compact	K668-001 (010)	35,5	63,5	74
	K668-002 (011)			
deska ARTECA/ARTECO duroplastowa, ARTECA/ARTECO duroplast toilet seat	K667-002	-	-	-
deska ARTECA/ARTECO duroplastowa, wolno opadająca, łatwo wypinająca się ARTECA/ARTECO duroplast slow-close, easy off toilet seat	K667-001	-	-	-
deska ARTECA/ARTECO polipropylenowa, antybakteryjna ARTECA/ARTECO polypropylene antibacterial toilet seat	K667-011	-	-	-

**CERAMIKA
SANITARNA
WC KOMPAKTY
SANITARY
CERAMICS
WC COMPACTS**

PARVA >

WC kompakt
PARVA
PARVA WC compact
Odpływ pionowy
36x58,5 cm
Odpływ poziomy
36x61,5 cm
Doprowadzenie
wody z boku.
Funkcja 3/6 l.
Vertical outflow
36x58,5 cm
horizontal
outflow
36x61,5 cm
Side water inlet
3/6 function.

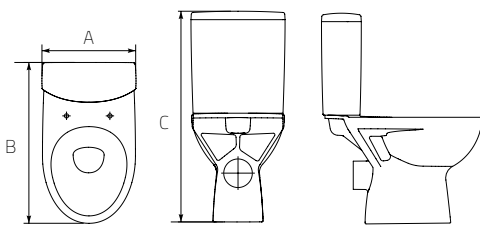

		A (cm)	B (cm)	C (cm)
WC kompakt PARVA 010 z deską duroplastową PARVA 010 WC compact with duroplast toilet seat	K27-001	36	61,5	78
WC kompakt PARVA 010 z deską duroplastową wolnoopadającą PARVA 010 WC compact with duroplast slow-close toilet seat	K27-002	36	61,5	78
WC kompakt PARVA 020 z deską duroplastową PARVA 020 WC compact with duroplast toilet seat	K27-003	36	59,5	78,5
WC kompakt PARVA 020 z deską duroplastową wolnoopadającą PARVA 020 WC compact with duroplast slow-close toilet seat	K27-004	36	59,5	78,5

IRYDA >

WC kompakt
IRYDA
IRYDA WC compact
38,5x63,5 cm
Odpływ poziomy.
Doprowadzenie
wody z boku.
Funkcja 3/6 l.
Horizontal
outflow
Side water inlet
3/6 function.

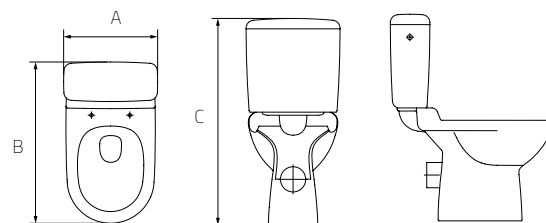

		A (cm)	B (cm)	C (cm)
WC kompakt IRYDA IRYDA WC compact	K02-021	38,5	63,5	82
deska duroplastowa, antybakteryjna IRYDA IRYDA duroplast antibacterial toilet seat	K98-0012	-	-	-
deska wolno opadająca, duroplastowa, antybakteryjna IRYDA IRYDA duroplast antibacterial slow-close toilet seat	K98-0070	-	-	-

NANO >
 WC kompakt
 NANO
NANO WC compact
 37×57 cm
 Miska uniwersalna.
 Doprowadzenie wody z dołu.
 Funkcja 2/4 l.
 Universal bowl
 bottom water inlet
 2/4 function.

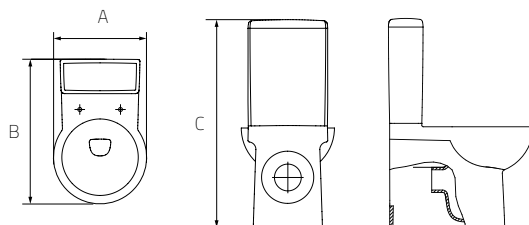

		A (cm)	B (cm)	C (cm)
WC kompakt NANO z deską duroplastową, antybakteryjną NANO WC compact with duroplast antibacterial toilet seat	K19-012	37	57	82,5
WC kompakt NANO z deską duroplastową, antybakteryjną, wolno opadającą NANO WC compact with duroplast antibacterial slow-close toilet seat	K19-013	37	57	82,5

FACILE >
 WC kompakt
 FACILE
FACILE WC compact
 35,5×62,5 cm
 Miska uniwersalna.
 Doprowadzenie wody z boku (010) lub z dołu (011).
 Funkcja 3/6 l.
 Universal bowl
 Side water inlet (010) or bottom water inlet (011)
 3/6 function.

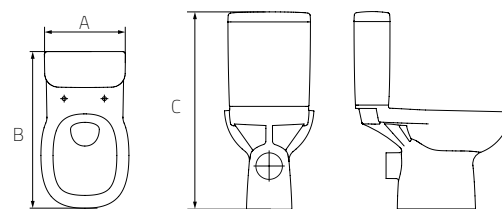

		A (cm)	B (cm)	C (cm)
WC kompakt FACILE 010 z deską duroplastową, antybakteryjną FACILE WC compact 010 with duroplast antibacterial toilet seat	K30-017	35,5	62,5	79,5
WC kompakt FACILE 011 z deską duroplastową, antybakteryjną FACILE WC compact 011 with duroplast antibacterial toilet seat	K30-009	35,5	62,5	79,5
WC kompakt FACILE 010 z deską duroplastową, wolno opadającą FACILE WC compact 010 with duroplast slow-close toilet seat	K30-008	34,5	62,5	79,5
WC kompakt FACILE 011 z deską duroplastową, wolno opadającą FACILE WC compact 011 with duroplast slow-close toilet seat	K30-016	34,5	62,5	79,5
WC kompakt FACILE 010 FACILE WC compact 010	K30-018	35,5	62,5	79,5

STANDARD

ZENIT >

WC kompakt
ZENIT
ZENIT
WC compact
35,5×65,5 cm
Miska pozioma.
Doprowadzenie
wody z boku.
Funkcja 3/6 l.
Horizontal bowl
Side water inlet
3/6 function.

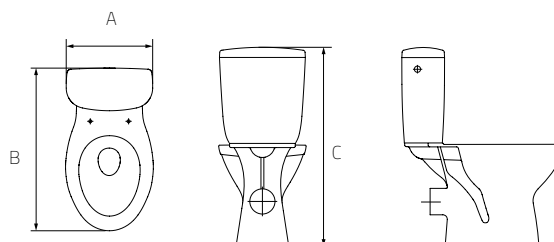

		A (cm)	B (cm)	C (cm)
WC kompakt ZENIT ZENIT WC compact	K100-210	35,5	65,5	79
WC kompakt ZENIT ZENIT WC compact	K100-211	35,5	65,5	79
deska duroplastowa antybakteryjna ZENIT ZENIT duroplast antibacterial toilet seat	K98-0031	-	-	-
deska polipropylenowa antybakteryjna ZENIT ZENIT polypropylene antibacterial toilet seat	K98-0035	-	-	-

MERIDA >

WC kompakt
MERIDA
MERIDA
WC compact
37×62,5 cm
Miska pozioma.
Doprowadzenie
wody z boku.
Funkcja 3/6 l.
Horizontal bowl
Side water inlet
3/6 function.

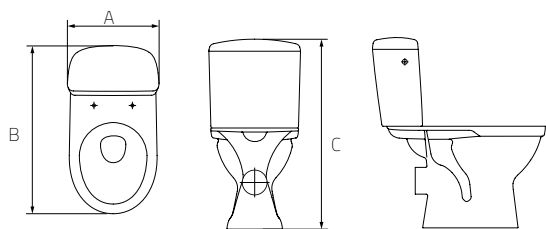

		A (cm)	B (cm)	C (cm)
WC Kompakt MERIDA 010 z deską polipropylenową, antybakteryjną MERIDA 010 WC compact with polypropylene antibacterial toilet seat	K03-014	37	62,5	75,5
WC Kompakt MERIDA 010 z deską duroplastową, antybakteryjną, wolno opadającą MERIDA 010 WC compact with duroplast antibacterial toilet seat	K03-018	37	62,5	75,5
duroplastowa, antybakteryjna MERIDA MERIDA duroplast antibacterial toilet seat	K98-0031	-	-	-
polipropylenowa, antybakteryjna MERIDA MERIDA polypropylene antibacterial toilet seat	K98-0035	-	-	-

PRESIDENT >

WC kompakt
PRESIDENT
PRESIDENT
WC compact
37,5×64,5 cm
Funkcja 3/6 l.
Doprowadzenie
wody z boku.
3/6 function
Side water inlet.

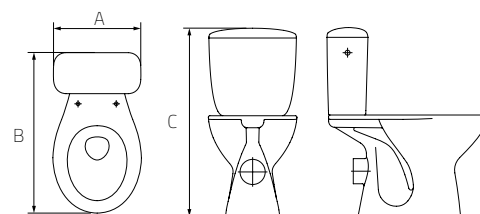

		A (cm)	B (cm)	C (cm)
WC kompakt PRESIDENT odpływ poziomy PRESIDENT WC compact horizontal outflow	K08-028 K08-038	37,5	64,5	75
WC kompakt PRESIDENT odpływ pionowy PRESIDENT WC compact vertical outflow	K08-029 K08-039	37,5	64,5	75
deska PRESIDENT polipropylenowa antybakteryjna PRESIDENT polypropylene antibacterial toilet seat	K98-0021	-	-	-
deska PRESIDENT duroplastowa antybakteryjna wolno opadająca, łatwo wypinająca się PRESIDENT duroplast antibacterial and easy-off slow-close toilet seat	K98-0074	-	-	-

STANDARD



**CERAMIKA
SANITARNA**
BIDETY
PISUARY
STELAŻE PODTYNKOWE
AKCESORIA
SANITARY
CERAMICS
BIDETS
URINALS
CONCEALED
CISTERN FRAMES
ACCESORIES

N^o4

**CERAMIKA
SANITARNA**
BIDETY
SANITARY
CERAMICS
BIDETS

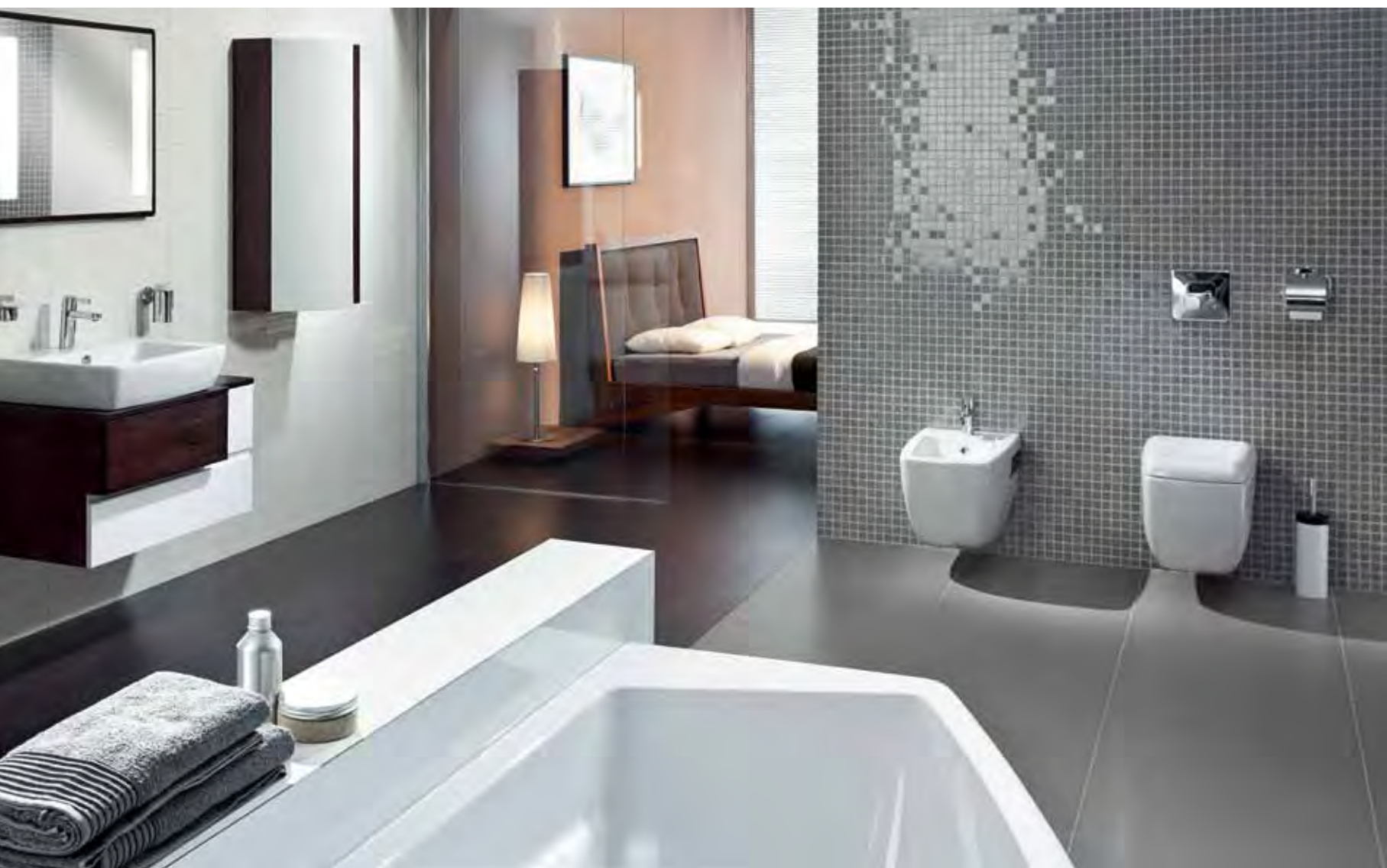



Ceramika sanitarna: seria Malmo
Sanitary ceramics: Malmo



BILBAO >

Bidet
zawieszany
BILBAO
BILBAO
wall hung bidet
40x57 cm
Z otworem
na armaturę.
With hole for
mixer.

**PERFECT
CLEAN**

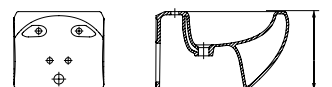
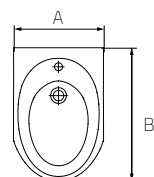

		A (cm)	B (cm)	C (cm)
bidet zawieszany BILBAO	OK-03-001	40	57	37
BILBAO wall hung bidet				

KIOTO >
 Bidet
 zawieszany
 KIOTO
KIOTO
wall hung bidet
 39 x 57,5 cm
 Z otworem
 na armaturę.
 With hole for
 mixer.
**PERFECT
 CLEAN**

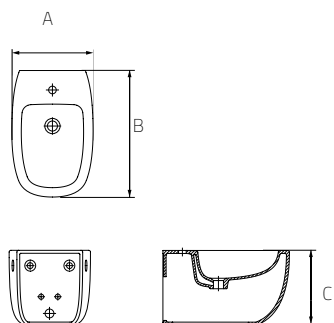

		A (cm)	B (cm)	C (cm)
bidet zawieszany KIOTO	OK-02-005	39	57,5	35
KIOTO wall hung bidet				

MALMO >
 Bidet
 zawieszany
 MALMO
MALMO
wall hung bidet
 36,5x58 cm
 Z otworem
 na armaturę.
 With hole for
 mixer.

**PERFECT
 CLEAN**



Bidet
 zawieszany
 MALMO
MALMO
wall hung bidet
 kasztan
 chestnut

Bidet
 zawieszany
 MALMO
MALMO
wall hung bidet
 wenge
 wenge

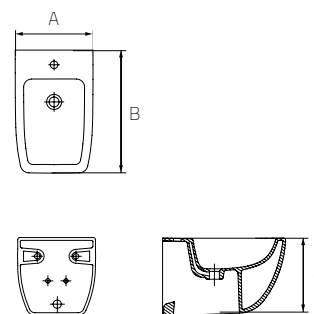

		A (cm)	B (cm)	C (cm)
bidet zawieszany MALMO	OK-01-004	36,5	58	36
MALMO wall hung bidet				

**PRE
 STI
 GE**

**CERAMIKA
SANITARNA**
BIDETY
SANITARY
CERAMICS
BIDETS

PURE >

Bidet
zawieszany
PURE

**PURE
wall hung bidet**

35,5x53,5 cm
Z otworem
na armaturę.
With hole for
mixer.

PURE SILVER
PROTECT

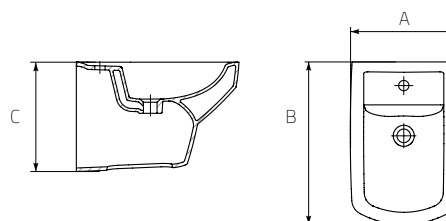

Bidet stojący
PURE

**PURE
stand bidet**

35,5x57,5 cm
Z otworem
na armaturę.
With hole for
mixer.

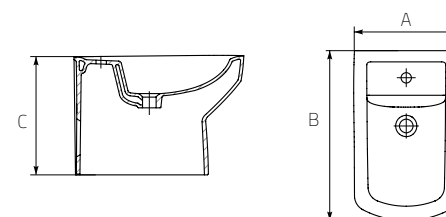

		A (cm)	B (cm)	C (cm)
bidet zawieszany PURE PURE wall hung bidet	K101-005 -BOX	35,5	53,5	37
bidet stojący PURE PURE stand bidet	K101-006 -BOX	35,5	57,5	40

CARINA >
Bidet
zawieszany
CARINA
wall hung bidet

35,5x52,5 cm
Z otworem
na armaturę.
With hole for
mixer.

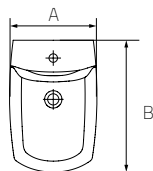
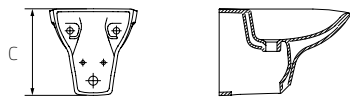

		A (cm)	B (cm)	C (cm)
bidet zawieszany CARINA CARINA wall hung bidet	K31-010	35,5	52,5	36

OLIMPIA >

Bidet
zawieszany
OLIMPIA
**OLIMPIA wall
hung bidet**
37x53 cm
Z otworem
na armaturę.
With hole for
mixer.

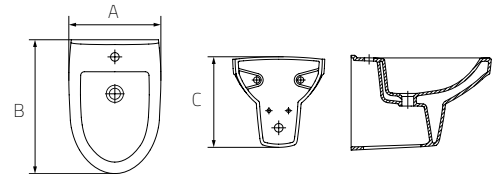

OLIMPIA >

Bidet stojący
OLIMPIA
OLIMPIA stand bidet
36,5x57 cm
Z otworem
na armaturę.
With hole for
mixer.

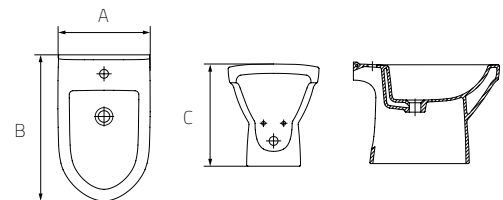

		A (cm)	B (cm)	C (cm)
bidet zawieszany OLIMPIA OLIMPIA wall hung bidet	K10-010	37	53	38
bidet stojący OLIMPIA OLIMPIA stand bidet	K10-009	36,5	57	39

DELFI >

Bidet
zawieszany
DELFI

**DELFI
wall hung bidet**

35,5×52,5 cm
Z otworem
na armaturę.
With hole for
mixer.

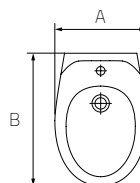
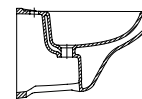
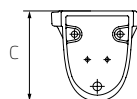

	A (cm)	B (cm)	C (cm)
bidet zawieszany DELFI DELFI wall hung bidet	K11-0018 35,5	52,5	37,5

IRYDA >

Bidet
zawieszany
IRYDA
**IRYDA
wall hung bidet**
36,5×53,5 cm
Z otworem
na armaturę.
With hole for
mixer.

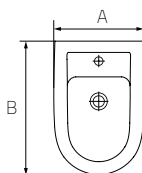
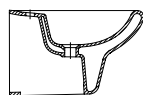
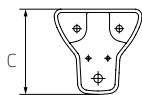

IRYDA >

Bidet
stojący IRYDA
**IRYDA
stand bidet**
37×58 cm
Z otworem
na armaturę.
With hole for
mixer.

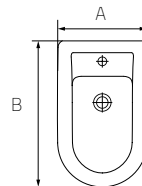
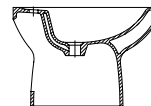
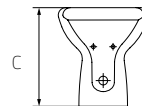

		A (cm)	B (cm)	C (cm)
bidet zawieszany IRYDA IRYDA wall hung bidet	K02-016	36,5	53,5	36,5
bidet stojący IRYDA IRYDA stand bidet	K02-014	37	58	40

STAN
DARD

Zawór do pisuaru zewnętrzny
External valve for urinal
Do kompletowania z pisua-
rem P101 i A101
For P101 and A101 urinals
K99-0022



Elektroniczna ścienna spłuczka pisuarowa na podczerwień, Zasilacz 24 V. Zasilanie z sieci.
Electronic wall urinal flusher with infrared sensor
17x17 cm
K97-254 (płytki)
K97-253 (zasilacz)



Zawór pisuaru A100, T100 z przyciskiem chromowanym VERONA
Valve for urinals A100, T100 with chrome button VERONA
K99-0029



P 101 >
Pisuar P101
P101 urinal
32x28 cm
Doprowadzenie wody z góry.
Top water inlet

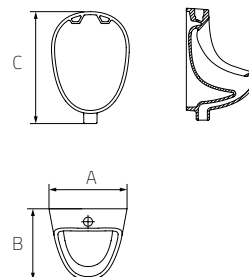

Przegroda pisuarowa
Urinal partition
40x68 cm



		A (cm)	B (cm)	C (cm)
pisuar P101 P101 urinal	K08-013	32	28	44,5
przegroda pisuarowa Urinal partition	K11-0031	8	40	68
Zawór do pisuaru zewnętrzny External valve for urinal	K99-0022	-	-	-

TAURUS >

Pisuar
TAURUS T 100
**TAURUS T 100
urinal**
41×37 cm
Doprowadzenie
wody z tyłu.
Back water
inlet.

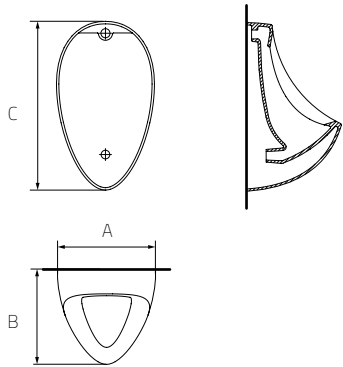

Przegroda
pisuarowa
Urinal partition
40x68 cm



		A (cm)	B (cm)	C (cm)
pisuar TAURUS T 100 TAURUS T 100 urinal	K11-0030	41	37	67
przegroda pisuarowa Urinal partition	K11-0031	8	40	68
przepływowa słuźka pisuarowa podtynkowa z czujnikiem na podczerwień zasilana baterią 6V concealed flow urinal flu- sher with infrared sensor, powered with 6V battery	K97-121	-	-	-
przepływowa słuźka pisuarowa podtynkowa z czujnikiem na podczer- wień do kompletowania z zasilaczem concealed flow urinal flu- sher with infrared sensor, to be completed with a power unit	K97-112	-	-	-
sitko do pisuaru TAURUS strainer for TAURUS urinal	K97-124	-	-	-

APOLLO >

Pisuar APOLLO
A100/ A101
**APOLLO A100/
A101
urinal**
34×29,5 cm
Doprowadzenie
wody z tyłu
(A 100) lub
z góry (A 101).
Back (A 100)
or top (A 101)
water inlet

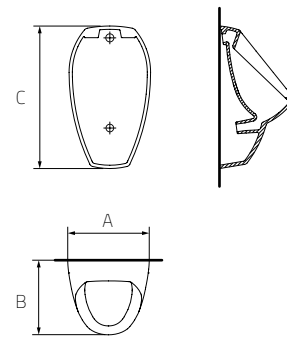

Przegroda
pisuarowa
Urinal partition
40x68 cm



		A (cm)	B (cm)	C (cm)
pisuar APOLLO A100 APOLLO A100 urinal	K11-0024	34	29,5	56,5
pisuar APOLLO A101 APOLLO A101 urinal	K11-0025	34	29,5	56,5
przegroda pisuarowa urinal partition	K11-0031	8	40	68
przepływowa słuźka pisuarowa podtynkowa z czujnikiem na podczerwień zasilana baterią 6V concealed flow urinal flu- sher with infrared sensor, powered with 6V battery	K97-121	-	-	-
przepływowa słuźka pisuarowa podtynkowa z czujnikiem na podczer- wień do kompletowania z zasilaczem concealed flow urinal flu- sher with infrared sensor, to be completed with a power unit	K97-112	-	-	-
sitko do pisuaru APOLLO strainer for APOLLO urinal	K97-123	-	-	-

**CERAMIKA
SANITARNA**
STELAŻE
PODTYNKOWE
SANITARY
CERAMICS
CONCEALED
CISTERN FRAMES

Stelaż podtynkowy do umywalk
Concealed cistern frame for washbasins
szer. 40 cm
width 40 cm
K97-063

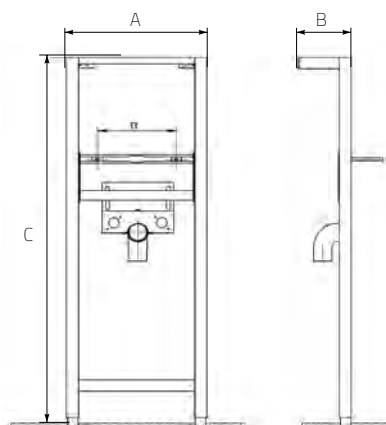

Stelaż podtynkowy do uchwytów dla niepełnosprawnych
Concealed cistern frame with support handles for the disabled
szer. 30 cm
width 30 cm
K97-122

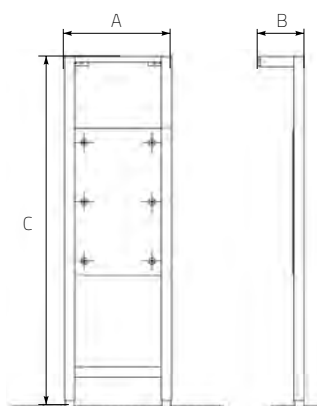

		A (cm)	B (cm)	C (cm)
Stelaż podtynkowy do umywalk Concealed cistern frame for washbasins	K97-063	40	15,5-23,5	112-129
Stelaż podtynkowy do uchwytów dla niepełnosprawnych Concealed cistern frame with support handles for the disabled	K97-122	30	15,5-23,5	112-129

Stelaż podtynkowy do bidetu
Concealed cistern frame for bidet
 szer. 50 cm
 width 50 cm
 K97-065

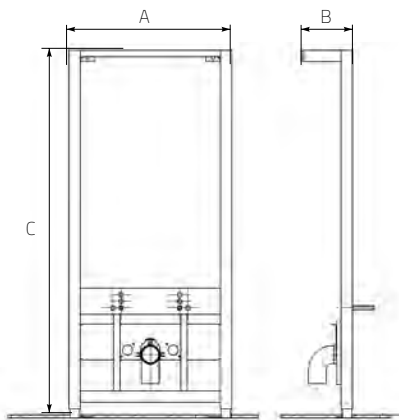

Stelaż podtynkowy do pisuaru
Concealed cistern frame for urinal
 szer. 45 cm
 width 45 cm
 K97-064

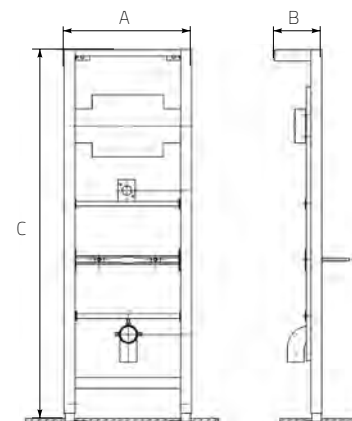

		A (cm)	B (cm)	C (cm)
Stelaż podtynkowy do bidetu Concealed cistern frame for bidet	K97-065	50	18-24,5	112-129
Stelaż podtynkowy do pisuaru Concealed cistern frame for urinal	K97-064	45	18-24,5	112-129

CERAMIKA SANITARNA STELAŻE PODTYNKOWE SANITARY CERAMICS CONCEALED CISTERN FRAMES

SLIM &SILENT

Zestaw podtynkowy SLIM&SILENT wysokość regulowana
SLIM&SILENT concealed cistern frame
Adjustable height
szer. 52,4 cm.
width 52,4 cm.

NOWOŚĆ/NEW

Stelaż podtynkowy SLIM&SILENT z miską PURE
Concealed cistern frame SLIM&SILENT with PURE wall-hung bowl
szer. 52,4 cm
width 52,4 cm
K97-273

Przycisk EGE
EGE flush button
wym. 17x27 cm
dim. 17x27 cm

Przycisk ADRIA
ADRIA flush button
wym. 17x26,5 cm
dim. 17x26,5 cm

Przycisk OTTO
OTTO flush button
wym. 17x27 cm
dim. 17x27 cm

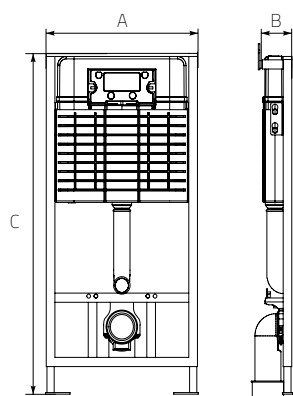

		A (cm)	B (cm)	C (cm)
Stelaż podtynkowy SLIM&SILENT SLIM&SILENT concealed cistern frame	K97-066	52,4	10,5-15	108-113
Zestaw podtynkowy SLIM & SILENT, z miską zawieszoną CARINA, deską duroplastową, wolnoopadającą. SLIM&SILENT concealed cistern frame with CARINA wall-hung toilet sea	K97-268	52,4	10,5-15	108-113
Zestaw podtynkowy SLIM & SILENT, z miską zawieszoną FACILE, deską duroplastową, antybakteryjną, wolnoopadającą. SLIM&SILENT concealed cistern frame with FACILE wall-hung bowl, duroplast, antibacterial slow-close toilet seat	K97-269	52,4	10,5-15	108-113
Zestaw podtynkowy SLIM & SILENT, z miską zawieszoną IRYDA, deską duroplastową, antybakteryjną. SLIM&SILENT concealed cistern frame with IRYDA wall-hung bowl, duroplast, antibacterial toilet seat	K97-270	52,4	10,5-15	108-113
Zestaw podtynkowy SLIM & SILENT, z miską zawieszoną NANO, deską duroplastową, wolnoopadającą, łatwowypinająca się. SLIM&SILENT concealed cistern frame with NANO wall-hung bowl, duroplast slow-close, easy off toilet seat	K97-271	52,4	10,5-15	108-113
Zestaw podtynkowy SLIM & SILENT, z miską zawieszoną OLIMPIA, deską duroplastową, antybakteryjną, wolnoopadającą. SLIM&SILENT concealed cistern frame with OLIMPIA wall-hung bowl, duroplast, antibacterial slow-close toilet seat	K97-272	52,4	10,5-15	108-113
Stelaż podtynkowy SLIM&SILENT z miską zawieszoną PURE, deską duroplastową, wolnoopadającą, łatwo wypinającą się. SLIM&SILENT concealed cistern frame with PURE wall-hung bowl, duroplast slow-close, easy off toilet seat	K97-273	52,4	10,5-15	108-113
Zestaw podtynkowy SLIM & SILENT, z miską zawieszoną PARVA, deską duroplastową, wolnoopadającą. SLIM&SILENT concealed cistern frame with PARVA wall-hung bowl, duroplast slow-close, toilet seat	K97-274	52,4	10,5-15	108-113
Zestaw podtynkowy SLIM & SILENT, z miską zawieszoną EASY, deską duroplastową, wolnoopadającą, łatwo wypinającą się. SLIM&SILENT concealed cistern frame with EASY wall-hung bowl, duroplast slow-close, easy off toilet seat	K97-275	52,4	10,5-15	108-113
Zestaw podtynkowy SLIM & SILENT, z miską zawieszoną COLOUR, deską duroplastową, wolnoopadającą. SLIM&SILENT concealed cistern frame with COLOUR wall-hung toilet seat	K97-276	52,4	10,5-15	108-113
Przycisk EGE biały, chrom błysk, chrom mat EGE flush button white, chrome glossy, chrome matt	K97-229 K97-230 K97-231	17	-	27
Przycisk ADRIA biały, chrom błysk, chrom mat ADRIA flush button white, chrome glossy, chrome matt	K97-232 K97-233 K97-234	17	-	26,5
Przycisk OTTO biały, chrom błysk, czarny OTTO flush button white, chrome glossy, black	K97-235 K97-236 K97-237	17	-	27

HI-TEC

Zestaw podtynkowy HI-TEC wysokość regulowana
HI-TEC concealed cistern frame
Adjustable height
 szer. 42,5 cm.
 width 42,5 cm.

NOWOŚĆ/NEW

Stelaż podtynkowy HI-TEC z miską EASY
Concealed cistern frame HI-TEC with EASY wall-hung bowl
 szer. 42,5 cm
 width 42,5 cm
 K97-284

HI-TEC przycisk BLICK
HI-TEC flush button BLICK
 wym. 15x22 cm
 dim. 15x22 cm

HI-TEC przycisk TEAR
HI-TEC flush button TEAR
 wym. 15x22 cm
 dim. 15x22 cm

HI-TEC przycisk CUBE
HI-TEC flush button CUBE
 wym. 15x22 cm
 dim. 15x22 cm

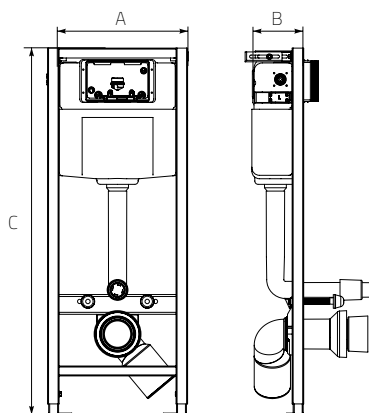

		A (cm)	B (cm)	C (cm)
Stelaż podtynkowy HI-TEC HI-TEC concealed cistern frame	K97-255	42,5	15,5-23,5	112-129
Zestaw podtynkowy HI-TEC z miską zawieszoną CARINA, deską duroplastową, wolno opadającą. HI-TEC concealed cistern frame with CARINA wall-hung bowl, duroplast, slow-close toilet seat	K97-277	42,5	15,5-23,5	112-129
Zestaw podtynkowy HI-TEC, z miską zawieszoną FACILE, deską duroplastową, antybakteryjną, wolno opadającą. HI-TEC concealed cistern frame with FACILE wall-hung bowl, duroplast, antibacterial, slow-close, toilet seat	K97-278	42,5	15,5-23,5	112-129
Zestaw podtynkowy HI-TEC, z miską zawieszoną IRYDA, deską duroplastową, antybakteryjną. HI-TEC concealed cistern frame with IRYDA wall-hung bowl, duroplast, antibacterial toilet seat	K97-279	42,5	15,5-23,5	112-129
Zestaw podtynkowy HI-TEC, z miską zawieszoną NANO, deską duroplastową, wolno opadającą, łatwopinająca się. HI-TEC concealed cistern frame with NANO wall-hung bowl, duroplast slow-close, easy off toilet seat	K97-280	42,5	15,5-23,5	112-129
Zestaw podtynkowy HI-TEC, z miską zawieszoną OLIMPIA, deską duroplastową, antybakteryjną, wolno opadającą. HI-TEC concealed cistern frame with OLIMPIA wall-hung bowl, duroplast, antibacterial, slow-close toilet seat	K97-281	42,5	15,5-23,5	112-129
Zestaw podtynkowy HI-TEC, z miską zawieszoną PURE, deską duroplastową, wolno opadającą, łatwopinającą się. HI-TEC concealed cistern frame with PURE wall-hung bowl, duroplast, slow-close, toilet seat	K97-282	42,5	15,5-23,5	112-129
Zestaw podtynkowy HI-TEC, z miską zawieszoną PARVA, deską duroplastową, wolno opadającą. HI-TEC concealed cistern frame with PARVA wall-hung bowl, duroplast, slow-close toilet seat	K97-283	42,5	15,5-23,5	112-129
Zestaw podtynkowy HI-TEC, miską zawieszoną EASY, deską duroplastową, wolno opadającą, łatwo wypinającą się. HI-TEC concealed cistern frame with EASY wall-hung bowl, duroplast, slow-close, easy off toilet seat	K97-284	42,5	15,5-23,5	112-129
Zestaw podtynkowy HI-TEC, z miską zawieszoną COLOUR, deską duroplastową, wolno opadającą, łatwo wypinającą się. HI-TEC concealed cistern frame with COLOUR wall-hung bowl, duroplast, slow-close, easy off toilet seat	K97-285	42,5	15,5-23,5	112-129
HI-TEC przycisk BLICK biały, chrom błysk, czarny HI-TEC button BLICK white, chrome glossy, black	K97-256 K97-257 K97-258	15	-	22
HI-TEC przycisk TEAR biały, chrom błysk, czarny HI-TEC button TEAR white, chrome glossy, black	K97-259 K97-260 K97-261	15	-	22
HI-TEC przycisk CUBE biały, chrom błysk HI-TEC button CUBE white, chrome glossy	K97-262 K97-263	15	-	22

Stelaze podtynkowe
 Concealed cistern frames

PRE
 STI
 GE

CERAMIKA SANITARNA STELAŻE PODTYNKOWE SANITARY CERAMICS CONCEALED CISTERN FRAMES

LINK

Zestaw podtynkowy LINK z miską zawieszoną COLOUR, deską duroplastową wolno opadającą LINK concealed cistern frame with COLOUR wall-hung bowl and duroplast slow-close toilet seat

Zestaw podtynkowy LINK z miską zawieszoną COLOUR, deską duroplastową LINK concealed cistern frame with COLOUR wall-hung bowl and duroplast toilet seat

Zestaw podtynkowy LINK z miską zawieszoną NANO, deską duroplastową wolno opadającą LINK concealed cistern frame with NANO wall-hung bowl and duroplast slow-close toilet seat

Zestaw podtynkowy LINK z miską zawieszoną NANO, deską duroplastową LINK concealed cistern frame with NANO wall-hung bowl and duroplast toilet seat

Zestaw podtynkowy LINK z miską zawieszoną CARINA, deską duroplastową wolno opadającą LINK concealed cistern frame with CARINA wall-hung bowl and duroplast slow-close toilet seat

Zestaw podtynkowy LINK z miską zawieszoną CARINA, deską duroplastową LINK concealed cistern frame with CARINA wall-hung bowl and duroplast toilet seat

Zestaw podtynkowy LINK z miską zawieszoną EASY, deską duroplastową wolno opadającą LINK concealed cistern frame with EASY wall-hung bowl and duroplast slow-close toilet seat

Zestaw podtynkowy LINK z miską zawieszoną EASY, deską duroplastową LINK concealed cistern frame with EASY wall-hung bowl and duroplast toilet seat

Zestaw podtynkowy LINK z miską zawieszoną IRYDA, deską duroplastową wolno opadającą LINK concealed cistern frame with IRYDA wall-hung bowl and duroplast slow-close toilet seat

Zestaw podtynkowy LINK z miską zawieszoną IRYDA, deską duroplastową LINK concealed cistern frame with IRYDA wall-hung bowl and duroplast toilet seat

Zestaw podtynkowy LINK z miską zawieszoną PURE, deską duroplastową wolno opadającą LINK concealed cistern frame with PURE wall-hung bowl and duroplast slow-close toilet seat

Zestaw podtynkowy LINK z miską zawieszoną PURE, deską duroplastową LINK concealed cistern frame with PURE wall-hung bowl and duroplast toilet seat

Zestaw podtynkowy LINK z miską zawieszoną OLIMPIA, deską duroplastową wolno opadającą LINK concealed cistern frame with OLIMPIA wall-hung bowl and duroplast slow-close toilet seat

Zestaw podtynkowy LINK z miską zawieszoną OLIMPIA, deską duroplastową LINK concealed cistern frame with OLIMPIA wall-hung bowl and duroplast toilet seat

Zestaw podtynkowy LINK z miską zawieszoną FACILE, deską duroplastową wolno opadającą LINK concealed cistern frame with FACILE wall-hung bowl and duroplast slow-close toilet seat

Zestaw podtynkowy LINK z miską zawieszoną FACILE, deską duroplastową LINK concealed cistern frame with FACILE wall-hung bowl and duroplast toilet seat

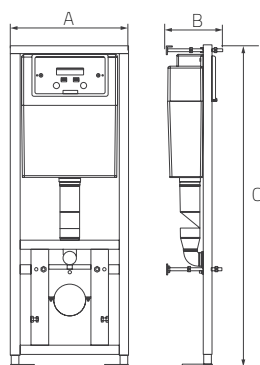

LINK



		A (cm)	B (cm)	C (cm)
Stelaż podtynkowy LINK LINK concealed cistern frame	K97-108	40	15,5-23,5	112-129
Zestaw podtynkowy LINK z miską zawieszoną DELFI, deską DELFI duroplastową LINK concealed cistern frame with DELFI wall-hung bowl and DELFI duroplast toilet seat	K97-102	40	15,5-23,5	112-129
Zestaw podtynkowy LINK z miską zawieszoną PRESIDENT, deską PRESIDENT polipropylenową LINK concealed cistern frame with PRESIDENT polypropylene toilet seat	K97-107	40	15,5-23,5	112-129
Zestaw podtynkowy LINK z miską zawieszoną PARVA, deską duroplastową wolno opadającą LINK concealed cistern frame with NANO wall-hung bowl and duroplast slow-close toilet seat	K97-296	40	15,5-23,5	112-129
Zestaw podtynkowy LINK z miską zawieszoną PARVA, deską duroplastową LINK concealed cistern frame with PARVA wall-hung bowl and duroplast toilet seat	K97-295	40	15,5-23,5	112-129
Zestaw podtynkowy LINK z miską zawieszoną PRESIDENT, deską duroplastową wolno opadającą LINK concealed cistern frame with PRESIDENT wall-hung bowl and duroplast slow-close toilet seat	K97-293	40	15,5-23,5	112-129
Zestaw podtynkowy LINK z miską zawieszoną PRESIDENT, deską duroplastową LINK concealed cistern frame with PRESIDENT wall-hung bowl and duroplast toilet seat	K97-106	40	15,5-23,5	112-129
Zestaw podtynkowy LINK z miską zawieszoną FACILE, deską duroplastową wolno opadającą LINK concealed cistern frame with FACILE wall-hung bowl and duroplast slow-close toilet seat	K97-267	40	15,5-23,5	112-129
Zestaw podtynkowy LINK z miską zawieszoną FACILE, deską duroplastową LINK concealed cistern frame with FACILE wall-hung bowl and duroplast toilet seat	K97-219	40	15,5-23,5	112-129

		A (cm)	B (cm)	C (cm)
Zestaw podtynkowy LINK z miską zawieszoną COLOUR, deską duroplastową wolno opadającą LINK concealed cistern frame with COLOUR wall-hung bowl and duroplast slow-close toilet seat	K97-301	40	15,5-23,5	112-129
Zestaw podtynkowy LINK z miską zawieszoną COLOUR, deską duroplastową LINK concealed cistern frame with COLOUR wall-hung bowl and duroplast toilet seat	K97-298	40	15,5-23,5	112-129
Zestaw podtynkowy LINK z miską zawieszoną NANO, deską duroplastową wolno opadającą LINK concealed cistern frame with NANO wall-hung bowl and duroplast slow-close toilet seat	K97-220	40	15,5-23,5	112-129
Zestaw podtynkowy LINK z miską zawieszoną NANO, deską duroplastową LINK concealed cistern frame with NANO wall-hung bowl and duroplast toilet seat	K97-290	40	15,5-23,5	112-129
Zestaw podtynkowy LINK z miską zawieszoną CARINA, deską duroplastową wolno opadającą LINK concealed cistern frame with CARINA wall-hung bowl and duroplast slow-close toilet seat	K97-218	40	15,5-23,5	112-129
Zestaw podtynkowy LINK z miską zawieszoną CARINA, deską duroplastową LINK concealed cistern frame with CARINA wall-hung bowl and duroplast toilet seat	K97-286	40	15,5-23,5	112-129
Zestaw podtynkowy LINK z miską zawieszoną EASY, deską duroplastową wolno opadającą LINK concealed cistern frame with EASY wall-hung bowl and duroplast slow-close toilet seat	K97-297	40	15,5-23,5	112-129
Zestaw podtynkowy LINK z miską zawieszoną EASY, deską duroplastową LINK concealed cistern frame with EASY wall-hung bowl and duroplast toilet seat	K97-300	40	15,5-23,5	112-129
Zestaw podtynkowy LINK z miską zawieszoną IRYDA, deską duroplastową wolno opadającą LINK concealed cistern frame with IRYDA wall-hung bowl and duroplast slow-close toilet seat	K97-289	40	15,5-23,5	112-129
Zestaw podtynkowy LINK z miską zawieszoną IRYDA, deską duroplastową LINK concealed cistern frame with IRYDA wall-hung bowl and duroplast toilet seat	K97-288	40	15,5-23,5	112-129
Zestaw podtynkowy LINK z miską zawieszoną PURE, deską duroplastową wolno opadającą LINK concealed cistern frame with PURE wall-hung bowl and duroplast slow-close toilet seat	K97-212	40	15,5-23,5	112-129
Zestaw podtynkowy LINK z miską zawieszoną PURE, deską duroplastową LINK concealed cistern frame with PURE wall-hung bowl and duroplast toilet seat	K97-294	40	15,5-23,5	112-129
Zestaw podtynkowy LINK z miską zawieszoną OLIMPIA, deską duroplastową wolno opadającą LINK concealed cistern frame with OLIMPIA wall-hung bowl and duroplast slow-close toilet seat	K97-292	40	15,5-23,5	112-129
Zestaw podtynkowy LINK z miską zawieszoną OLIMPIA, deską duroplastową LINK concealed cistern frame with OLIMPIA wall-hung bowl and duroplast toilet seat	K97-291	40	15,5-23,5	112-129
przyciski LINK LINK flush buttons	K97-086 b K97-087 cb K97-088 cm	22	1,3	15
przyciski LINK kwadrat LINK SQUARE flush buttons	K97-173 b K97-175 cb K97-174 cm	22	1,3	15
przyciski LINK kółko LINK RING flush buttons	K97-089 b K97-090 cb K97-091 cm	22	1,3	15
przycisk antybakteryjny PURE PURE flush buttons antibacterial	K97-193 b K97-194 cb	22	1,3	15

b - biały, cb - chrom błysk, cm - chrom mat
b - white, cb - chrome shine, cm - chrome matt

TARGET >

Zestaw podtynkowy TARGET wy-sokość regulowa-na
TARGET concealed cistern frame
Adjustable height
szer. 35 cm.
width 35 cm.

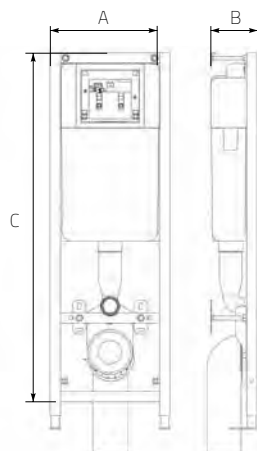

		A (cm)	B (cm)	C (cm)
Stelaż podtynkowy TARGET TARGET concealed cistern frame	K97-331	35	14,2-24,5	108-128
Zestaw podtynkowy TARGET z miską zawieszoną PARVA, deską duroplastową wolno opadającą TARGET concealed cistern frame with PARVA wall-hung bowl and duroplast slow-close toilet seat	K97-313	35	14,2-24,5	108-128
Zestaw podtynkowy TARGET z miską zawieszoną PARVA, deską duroplastową TARGET concealed cistern frame with PARVA wall-hung bowl and duroplast toilet seat	K97-312	35	14,2-24,5	108-128
Zestaw podtynkowy TARGET z miską zawieszoną PRESIDENT, deską duroplastową wolno opadającą TARGET concealed cistern frame with PRESIDENT wall-hung bowl and duroplast slow-close toilet seat	K97-308	35	14,2-24,5	108-128
Zestaw podtynkowy TARGET z miską zawieszoną PRESIDENT, deską duroplastową TARGET concealed cistern frame with PRESIDENT wall-hung bowl and duroplast toilet seat	K97-309	35	14,2-24,5	108-128
Zestaw podtynkowy TARGET z miską zawieszoną FACILE, deską duroplastową wolno opadającą TARGET concealed cistern frame with FACILE wall-hung bowl and duroplast slow-close toilet seat	K97-303	35	14,2-24,5	108-128
Zestaw podtynkowy TARGET z miską zawieszoną FACILE, deską duroplastową TARGET concealed cistern frame with FACILE wall-hung bowl and duroplast toilet seat	K97-317	35	14,2-24,5	108-128
Zestaw podtynkowy TARGET z miską zawieszoną COLOUR, deską duroplastową wolno opadającą TARGET concealed cistern frame with COLOUR wall-hung bowl and duroplast slow-close toilet seat	K97-316	35	14,2-24,5	108-128
Zestaw podtynkowy TARGET z miską zawieszoną COLOUR, deską duroplastową TARGET concealed cistern frame with COLOUR wall-hung bowl and duroplast toilet seat	K97-305	35	14,2-24,5	108-128

		A (cm)	B (cm)	C (cm)
Zestaw podtynkowy TARGET z miską zawieszoną NANO, deską duroplastową wolno opadającą TARGET concealed cistern frame with NANO wall-hung bowl and duroplast slow-close toilet seat	K97-306	35	14,2-24,5	108-128
Zestaw podtynkowy TARGET z miską zawieszoną NANO, deską duroplastową TARGET concealed cistern frame with NANO wall-hung bowl and duroplast toilet seat	K97-302	35	14,2-24,5	108-128
Zestaw podtynkowy TARGET z miską zawieszoną CARINA, deską duroplastową wolno opadającą TARGET concealed cistern frame with CARINA wall-hung bowl and duroplast slow-close toilet seat	K97-287	35	14,2-24,5	108-128
Zestaw podtynkowy TARGET z miską zawieszoną CARINA, deską duroplastową TARGET concealed cistern frame with CARINA wall-hung bowl and duroplast toilet seat	S704-001	35	14,2-24,5	108-128
Zestaw podtynkowy TARGET z miską zawieszoną EASY, deską duroplastową wolno opadającą TARGET concealed cistern frame with EASY wall-hung bowl and duroplast slow-close toilet seat	K97-314	35	14,2-24,5	108-128
Zestaw podtynkowy TARGET z miską zawieszoną EASY, deską duroplastową TARGET concealed cistern frame with EASY wall-hung bowl and duroplast toilet seat	K97-315	35	14,2-24,5	108-128
Zestaw podtynkowy TARGET z miską zawieszoną IRYDA, deską duroplastową wolno opadającą TARGET concealed cistern frame with IRYDA wall-hung bowl and duroplast slow-close toilet seat	K97-304	35	14,2-24,5	108-128
Zestaw podtynkowy TARGET z miską zawieszoną IRYDA, deską duroplastową TARGET concealed cistern frame with IRYDA wall-hung bowl and duroplast toilet seat	K97-299	35	14,2-24,5	108-128
Zestaw podtynkowy TARGET z miską zawieszoną PURE, deską duroplastową wolno opadającą TARGET concealed cistern frame with PURE wall-hung bowl and duroplast slow-close toilet seat	K97-311	35	14,2-24,5	108-128
Zestaw podtynkowy TARGET z miską zawieszoną PURE, deską duroplastową TARGET concealed cistern frame with PURE wall-hung bowl and duroplast toilet seat	K97-310	35	14,2-24,5	108-128
Zestaw podtynkowy TARGET z miską zawieszoną OLIMPIA, deską duroplastową wolno opadającą TARGET concealed cistern frame with OLIMPIA wall-hung bowl and duroplast slow-close toilet seat	K97-307	35	14,2-24,5	108-128
Zestaw podtynkowy TARGET z miską zawieszoną OLIMPIA, deską duroplastową TARGET concealed cistern frame with PURE wall-hung bowl and duroplast toilet seat	K97-318	35	14,2-24,5	108-128
Przycisk TARGET L biały TARGET L flush button white	K97-326	20	1,8	18,1
Przycisk TARGET L chrom mat TARGET L flush button chrome matt	K97-321	20	1,8	18,1
Przycisk TARGET L chrom błysk TARGET L flush button chrome shine	K97-322	20	1,8	18,1
Przycisk TARGET S biały TARGET S flush button white	K97-323	20	1,1	18
Przycisk TARGET S chrom mat TARGET S flush button chrome matt	K97-324	20	1,1	18
Przycisk TARGET S chrom błysk TARGET S flush button chrome shine	K97-325	20	1,1	18
Przycisk TARGET Segment chrom błysk TARGET Segment flush button chrome shine	K97-327	20	0,85	17,6
Przycisk TARGET Segment biały	K97-328	20	0,85	17,6
Przycisk TARGET Square biały	K97-329	20	0,85	17,6
Przycisk TARGET Square chrom błysk	K97-330	20	0,85	17,6

**CERAMIKA
SANITARNA
WYPOSAŻENIE DLA
NIEPEŁNOSPRAWNYCH
SANITARY
CERAMICS
BATHROOM FIXTURES
FOR THE DISABLED**

ETIUDA >

umywalka
ETIUDA 65
**ETIUDA 65
washbasin**
66x55 cm
Z otworem na
armaturę.
Mocowanie na
wspornikach.
With hole for
mixer.
Mounted on
bearers.

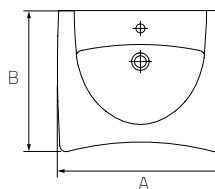

Uchwyt umy-
walkowy stały,
prawy/lewy
**Washbasin
handle – stable,
right/left**
dł. 50 cm
Maksymalne
obciążenie:
120 kg
length: 50 cm
Maximum load:
120 kg



Uchwyt
prosty 40
**Straight
handle 40**
dł. 40 cm
Maksymalne
obciążenie:
120 kg
length: 40 cm
Maximum load:
120 kg



Rama uchylna
do umywalki
ETIUDA 65
**ETIUDA 65 tilting
frame for wash-
basin**



Uchwyt ścienny
poziomo-piono-
wy, prawy/lewy
**Wall handle –
vertical/horizon-
tal, right/left**
50x70 cm
Maksymalne
obciążenie:
120 kg
Maximum load:
120 kg



ETIUDA >

Miska zawieszana ETIUDA
ETIUDA wall hung bowl
 38x73 cm
 Odpływ poziomy.
 Horizontal outflow



Lustro uchylne
Lifted mirror
 60x60 cm



Uchwyt uchylny mocowany do podłogi
Lifted handle assembled to the floor
 60x80 cm
 Maksymalne obciążenie:
 120 kg
 Maximum load:
 120 kg

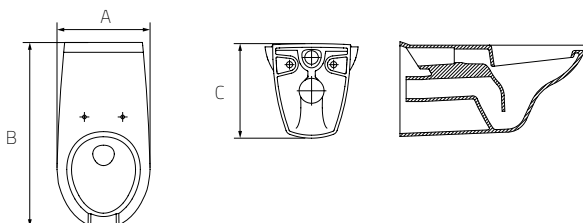

Uchwyt ścienny uchylny 60
Lifted wall handle 60
 dł. 60 cm
 length: 60 cm



Krzeselko prysznicowe składane
Folding shower chair
 45x40 cm
 Maksymalne obciążenie:
 120 kg
 Maximum load:
 120 kg



Uchwyt ścienny-podłogowy, prawy/lewy
Wall-flooring handle, right/left
 75x80 cm
 Maksymalne obciążenie:
 120 kg
 Maximum load:
 120 kg



		A (cm)	B (cm)	C (cm)
umywalka ETIUDA 65 ETIUDA 65 washbasin	K11-0041	40	66	15,5
miska zawieszana ETIUDA ETIUDA wall hung bowl	K11-0042	38	73	39
rama uchylna do umywalki ETIUDA 65 ETIUDA 65 tilting frame for washbasin	K97-072	-	-	-
Uchwyt prosty 40 Straight handle 40	K97-026	-	-	-
Uchwyt prosty 60 Straight handle 60	K97-027	-	-	-
Uchwyt prosty 80 Straight handle 80	K97-028	-	-	-
Uchwyt umywalkowy stały lewy/prawy Washbasin handle – stable, right/left	prawy right K97-029, lewy left K97-030	-	-	-
Uchwyt ścienny poziomo-pionowy, prawy/lewy Wall handle – vertical/horizontal, right/left	prawy right K97-031, lewy left K97-032	-	-	-
Uchwyt ścienny stały 60 Stable wall handle 60	K97-033	-	-	-
Uchwyt ścienny uchylny 60 Stable wall handle 60	K97-034	-	-	-
Uchwyt ścienny uchylny 75 Lifted wall handle 75	K97-035	-	-	-
Uchwyt uchylny mocowany do podłogi Lifted handle assembled to the floor	K97-036	-	-	-
Uchwyt ścienny-podłogowy, prawy/lewy Wall-flooring handle, right/left	prawy right K97-037, lewy left K97-038	-	-	-
Krzeselko prysznicowe składane Folding shower chair	K97-040	-	-	-
Lustro uchylne Lifted mirror	K97-039	-	-	-
deska duroplastowa, antybakteryjna ETIUDA ETIUDA duroplast antibacterial toilet seat	K98-0002	-	-	-

WANNY
KABINY
BRODZIKI
BATHTUBS
SHOWER
ENCLOSURES
SHOWER
TRAYS



WANNY
KABINY
BRODZIKI
CECHY
PRODUKTÓW
BATHTUBS
SHOWER
ENCLOSURES
SHOWER TRAYS
PRODUCT
FEATURES

WANNY
BATHTUBS

7
YEAR
WARRANTY

7 LAT GWARANCJI NA WANNE
7-YEAR WARRANTY FOR BATHTUBS

Wysoka jakość wanien Rovese daje komfort użytkowania przez wiele lat.

Cersanit's top quality bathtubs provide comfort of use for many years.



ODPORNOŚĆ NA OBCIĄŻENIE DO 400 KG
WEIGHT CAPACITY UP TO 400 KG

Solidna i trwała konstrukcja przetestowana została pod obciążeniem 400 kg.

Solid and durable structures tested to withstand weight up to 400 kg.



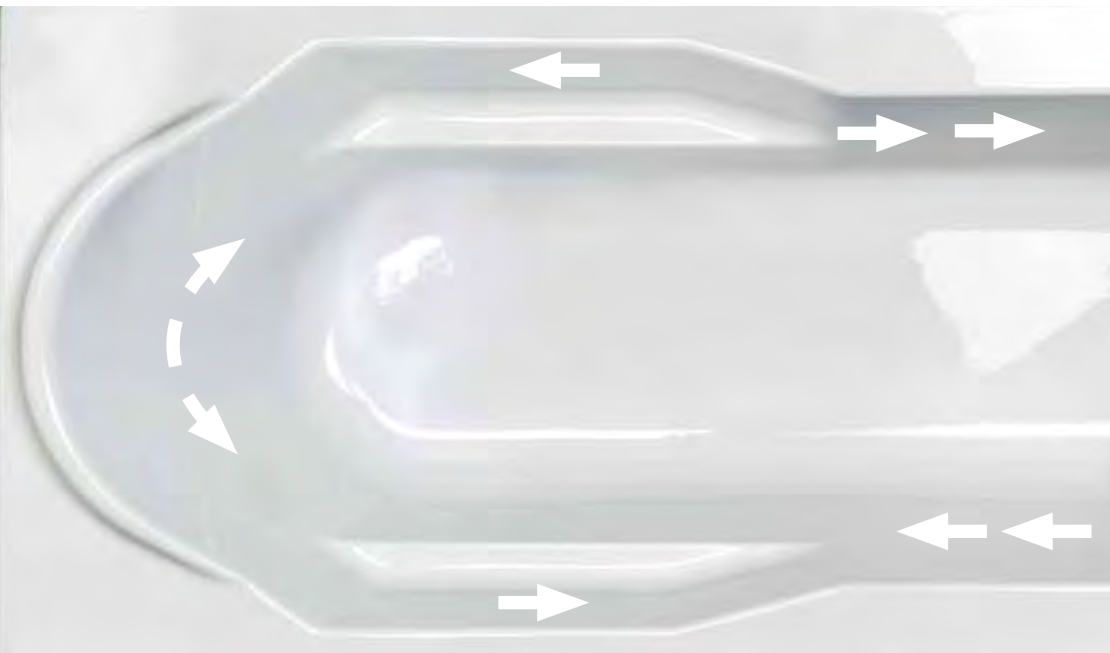

ERGONOMICZNY KSZTAŁT
ERGONOMIC SHAPES

Każda wanna projektowana jest z zachowaniem wszelkich zasad ergonomii. Zapewnia to właściwe ułożenie ciała podczas kąpieli i co za tym idzie komfortowe korzystanie z wanny

Ergonomically designed bathtubs for proper bathing positions and comfort of use.

100% AKRYL NAJWYŻSZEJ JAKOŚCI.

100% TOP-QUALITY ACRYLIC

Dzięki zastosowaniu 100% akrylu sanitarnego LUCITE® nasze wanny mają gładką powierzchnię, są przyjemne w dotyku i łatwe w utrzymaniu czystości. Mają też dobre właściwości izolacyjne - dłużej utrzymują temperaturę kąpieli.

Featuring 100% sanitary acrylic LUCITE®, Rovese's bathtubs are smooth, pleasant to the touch, and easy to clean. In addition, they have good insulation properties to keep bathwater warm for longer.



PODWÓJNE WZMOCNIENIE
DOUBLE REINFORCEMENT

Dzięki zastosowaniu podwójnego wzmocnienia z żywicy i włókna szklanego, korzystanie z naszych wanien jest komfortowe i bezpieczne.

Reinforced with both resin and glassfiber, our bathtubs provide comfort and safety of use.

- 1/akryl
- 2/wzmocnienie konstrukcji
- 3/włókno szklane z żywicą
- 1/acrylic
- 2/reinforcement
- 3/glassfiber with resin

WANNY
KABINY
BRODZIKI
CECHY
PRODUKTÓW
BATHTUBS
SHOWER
ENCLOSURES
SHOWER TRAYS
PRODUCT
FEATURES

KABINY
BRODZIKI
SHOWER
ENCLOSURES
SHOWER
TRAYS

5
YEAR
WARRANTY
SHOWER
ENCLOSURES

7
YEAR
WARRANTY
SHOWER
TRAYS

DŁUGOLETνια GWARANCJA
LONG WARRANTY

Wysoka jakość kabin Rovese daje komfort użytkowania przez wiele lat. Kabiny objęte są 5-letnią a brodziki 7-letnią gwarancją. Cersanit's top quality shower enclosures offer comfort of use for many years. We provide a 5-year warranty for shower enclosures and a 7-year warranty for shower trays.

ERGONOMICZNE DWUSTRONNE UCHWYTY
ERGONOMIC TWO-SIDED HANDLES

Zapewniają wygodę korzystania, ułatwiają otwieranie kabiny od środka.
For comfort of use and easy opening of shower enclosures from the inside.

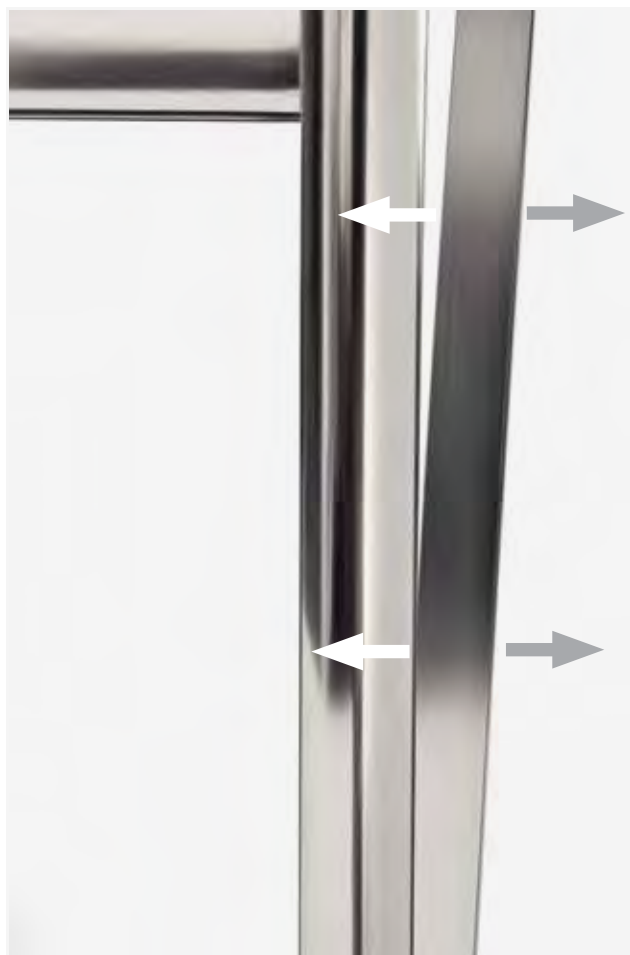

NIWELACJA KRZYWIZN ŚCIANY
ADJUSTMENT FOR UNEVEN WALLS

Regulowana listwa przyścienna umożliwia montaż nawet w przypadku krzywizny ściany. An adjustable skirting for installation even with uneven walls.



**SZTYWNA KONSTRUKCJA BRODZIKÓW
REINFORCED SHOWER TRAYS**

Dzięki dodatkowym wzmocnieniom nasze brodziki są stabilne, bezpieczne i komfortowe w użytkowaniu.

Dzięki dodatkowym wzmocnieniom nasze brodziki są stabilne, bezpieczne i komfortowe w użytkowaniu.

- 1/akryl
- 2/wzmocnienie konstrukcji
- 3/włókno szklane z żywicą
- 1/acrylic
- 2/reinforcement
- 3/glassfiber with resin

**BEZPIECZNE HARTOWANE SZKŁO
SAFE TOUGHENED GLASS**

Wysokiej jakości hartowanie szkła o grubości 5 lub 6 mm zapewnia stabilność i bezpieczeństwo użytkowania kabin.

Shower enclosures are made of top quality 5mm or 6mm toughened glass to ensure stability and safety of use.



1/METALOWY SYSTEM JEZDNY

METAL TRACK SYSTEM

Zapewnia bardzo ciche i płynne otwieranie kabiny.

For very quiet and smooth opening.

2/PODWÓJNE METALOWE GÓRNE ROLKI

DOUBLE UPPER ROLLERS MADE OF METAL

Najwyższej jakości system jezdny, gwarantujący stabilność konstrukcji i komfort przesuwania drzwi.

A top-quality track system for stability and comfortable sliding of doors.

3/WYPINANE DOLNE ROLKI

DETACHABLE LOWER ROLLERS

Łatwe wypinanie rolek pozwala na wygodne odchylenie szyby i ułatwia czyszczenie kabiny.

Easily detached rollers for comfortable use and easy cleaning.

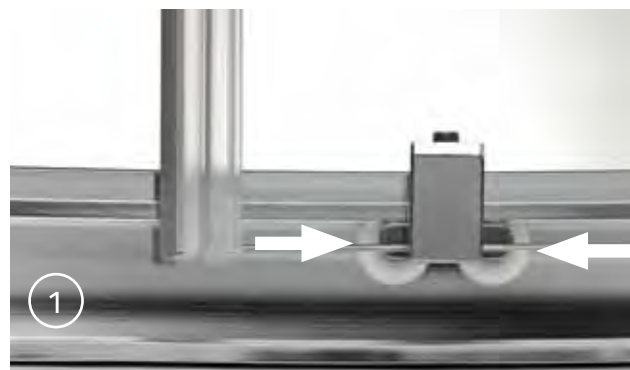



Nº 1





WANNY
BATHTUBS





Ceramika sanitarna: seria Iryda
Wanna: Flavia 160
Płytki: kolekcja Lazio beige, white
Sanitary ceramics: Iryda
Bathtub: Flavia 160
Ceramic tiles: Lazio beige, white

ZEN >

Wanna
prostokątna
ZEN 170
ZEN 170 rectangular bathtub
170x85cm

NOWOŚĆ / NEW

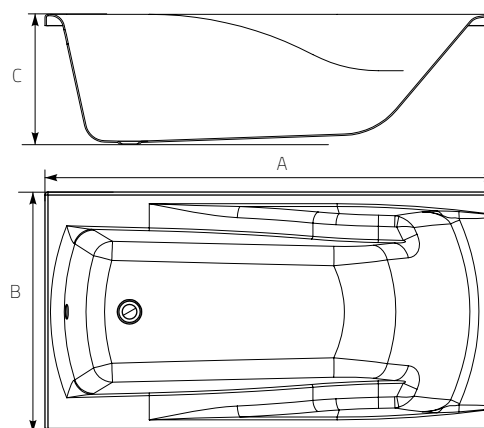

		A (cm)	B (cm)	C (cm)
wanna prostokątna ZEN 160 ZEN 160 rectangular bathtub	S301-127	160	85	44
wanna prostokątna ZEN 170 ZEN 170 rectangular bathtub	S301-128	170	85	44
wanna prostokątna ZEN 180 ZEN 180 rectangular bathtub	S301-129	180	85	44
panel czołowy VIRGO 160 VIRGO 160 front casing	S401-045	-	-	-
panel czołowy VIRGO 170 VIRGO 170 front casing	S401-046	-	-	-
panel czołowy VIRGO 180 VIRGO 180 front casing	S401-088	-	-	-
panel boczny ZEN ZEN side casing	S401-100	-	-	-

KORAT >

Wanna
prostokątna
KORAT 160
KORAT 160
rectangular
bathtub
160x70cm

NOWOŚĆ/NEW

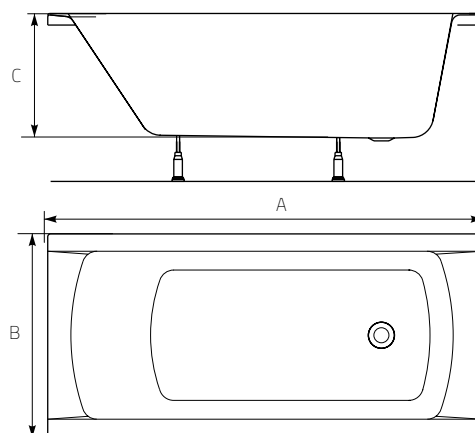

		A (cm)	B (cm)	C (cm)
wanna prostokątna KORAT 150 KORAT 150 rectangular bathtub	S301-120	150	70	43
wanna prostokątna KORAT 160 KORAT 160 rectangular bathtub	S301-121	160	70	43
wanna prostokątna KORAT 170 KORAT 170 rectangular bathtub	S301-122	170	70	43
panel czołowy LORENA 150 LORENA 150 front casing	S401-067	-	-	-
panel czołowy LORENA 160 LORENA 160 front casing	S401-068	-	-	-
panel czołowy LORENA 170 LORENA 170 front casing	S401-069	-	-	-
panel boczny LORENA LORENA side casing	S401-071	-	-	-

WANNY BATHTUBS

MEZA >

Wanna
asymetryczna
prawa/lewa
MEZA 160
MEZA 160
asymmetric
bathtub right/
left
160×100 cm

NOWOŚĆ/NEW

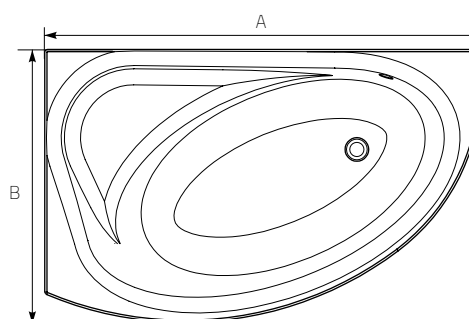
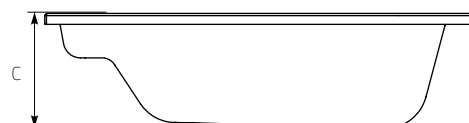

		A (cm)	B (cm)	C (cm)
wanna asymetryczna MEZA 160 MEZA 160 asymmetric bathtub	prawa right S301-123	160	100	42
wanna asymetryczna MEZA 160 MEZA 160 asymmetric bathtub	lewa left S301-124	160	100	42
wanna asymetryczna MEZA 170 MEZA 170 asymmetric bathtub	prawa right S301-125	170	100	42
wanna asymetryczna MEZA 170 MEZA 170 asymmetric bathtub	lewa left S301-126	170	100	42
panel czołowy MEZA 160 MEZA 160 front casing	S401-097	-	-	-
panel czołowy MEZA 170 MEZA 170 front casing	S401-098	-	-	-

VIRGO

Wanna
prostokątna
VIRGO 140
**VIRGO 140
rectangular
bathtub**
140×75 cm

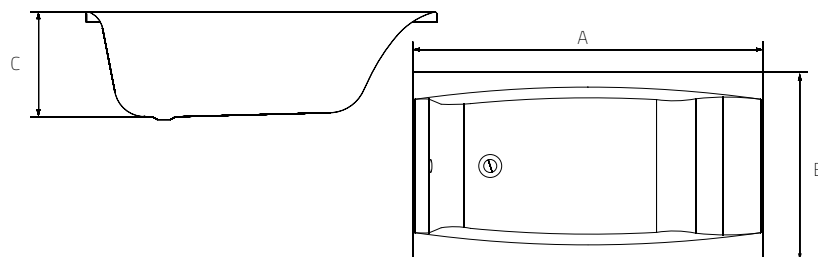

		A (cm)	B (cm)	C (cm)
wanna prostokątna VIRGO 140 VIRGO 140 rectangular bathtub	S301-065	140	75	43
panel czołowy VIRGO/INTRO 140 VIRGO/INTRO 140 front casing	S401-043	-	-	-
wanna prostokątna VIRGO 150 VIRGO 150 rectangular bathtub	S301-048	150	75	42
panel czołowy VIRGO/INTRO 150 VIRGO/INTRO 150 front casing	S401-044	-	-	-
wanna prostokątna VIRGO 160 VIRGO 160 rectangular bathtub	S301-046	160	75	42
panel czołowy VIRGO/INTRO 160 VIRGO/INTRO 160 front casing	S401-045	-	-	-
wanna prostokątna VIRGO 170 VIRGO 170 rectangular bathtub	S301-045	170	75	43
panel czołowy VIRGO/INTRO 170 VIRGO/INTRO 170 front casing	S401-046	-	-	-
panel boczny VIRGO/INTRO VIRGO/INTRO side casing	S407-047	-	-	-
wanna prostokątna VIRGO 180 VIRGO 180 rectangular bathtub	S301-103	180	75	43
panel czołowy VIRGO 180 VIRGO 180 front casing	S401-088	-	-	-
panel boczny VIRGO 180 VIRGO 180 side casing	S407-089	-	-	-

WANNY BATHTUBS

MALMO >

Wanna prostokątna MALMO 180
MALMO 180 rectangular bathtub
180x80cm
W komplecie z zagłówkiem, syfonem i nóżkami do montażu.
Complete with headrest, trap and feet for installation.

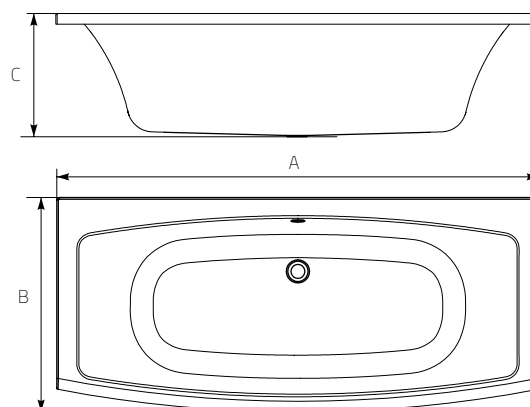

zagłówek do wanien MALMO
MALMO headrest



		A (cm)	B (cm)	C (cm)
wanna prostokątna MALMO 180 MALMO 180 rectangular bathtub	05-301-003	180	80	46
panel czołowy MALMO 180 MALMO 180 front casing	05-401-003	-	-	-
panel boczny MALMO MALMO side casing	05-401-004	-	-	-

BILBAO >

Wanna
BILBAO 170
**BILBAO 170
bathtub**
170×90 cm

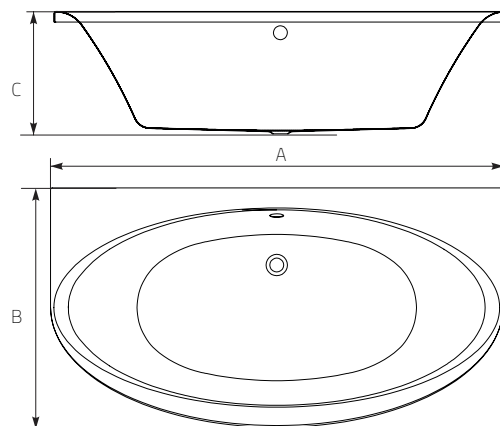

		A (cm)	B (cm)	C (cm)
wanna BILBAO 170 BILBAO 170 bathtub	05-301-001	170	90	45
panel czołowy BILBAO 170 BILBAO 170 front casing	05-401-005	-	-	-
panel boczny BILBAO BILBAO side casing	05-401-006	-	-	-

WANNY BATHTUBS

PURE

Wanna
prostokątna
PURE 140
**rectangular
bathtub**
PURE 140
140x70cm

PURE SILVER
PRODUCT

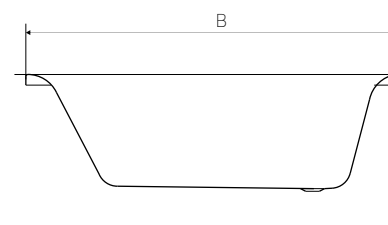
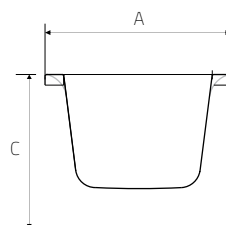

		A (cm) ; B (cm) ; C (cm)		
wanna prostokątna PURE 140 PURE 140 rectangular bathtub	S301-099	140	70	58
panel czołowy PURE 140 PURE 140 front casing	S401-081	-	-	-
wanna prostokątna PURE 150 PURE 150 rectangular bathtub	S301-100	150	70	39
panel czołowy PURE 150 PURE 150 front casing	S401-082	-	-	-
wanna prostokątna PURE 160 PURE 160 rectangular bathtub	S301-101	160	54,5	39
panel czołowy PURE 160 PURE 160 front casing	S401-083	-	-	-
wanna prostokątna PURE 160 PURE 160 rectangular bathtub	S301-102	170	54,5	39
panel czołowy PURE 160 PURE 160 front casing	S401-084	-	-	-
panel boczny PURE PURE side casing	S401-080	-	-	-

INTRO >

Wanna
prostokątna
INTRO 140
INTRO 140
rectangular
bathtub
140×75 cm

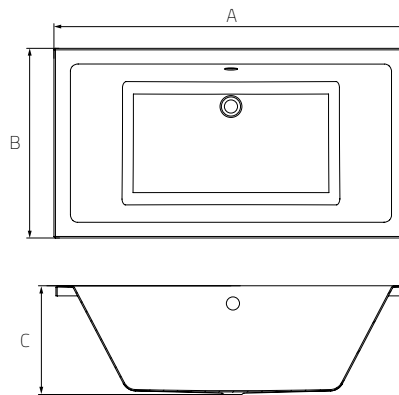

		A (cm)	B (cm)	C (cm)
wanna prostokątna INTRO 140 INTRO 140 rectangular bathtub	S301-065	140	75	43
panel czołowy VIRGO/INTRO 140 VIRGO/INTRO 140 front casing	S401-043	-	-	-
wanna prostokątna INTRO 150 INTRO 150 rectangular bathtub	S301-066	150	75	43
panel czołowy VIRGO/INTRO 150 VIRGO/INTRO 150 front casing	S401-044	-	-	-
wanna prostokątna INTRO 160 INTRO 160 rectangular bathtub	S301-067	160	75	43
panel czołowy VIRGO/INTRO 160 VIRGO/INTRO 160 front casing	S401-045	-	-	-
wanna prostokątna INTRO 170 INTRO 170 rectangular bathtub	S301-068	170	75	43
panel czołowy VIRGO/INTRO 170 VIRGO/INTRO 170 front casing	S401-046	-	-	-
panel boczny VIRGO/INTRO VIRGO/INTRO side casing	S401-047	-	-	-

WANNY BATHTUBS

SICILIA >

Wanna
asymetryczna
SICILIA 160
**SICILIA 160
bathtub
asymmetric**
160×100 cm

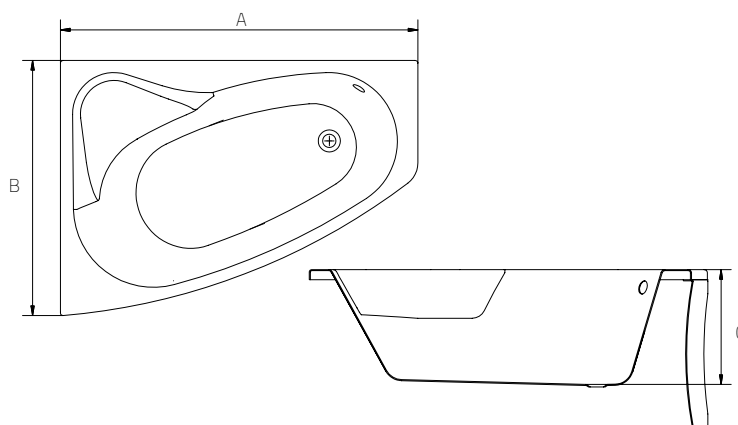

		A (cm)	B (cm)	C (cm)
wanna asymetryczna SICILIA 140 SICILIA 140 asymmetric bathtub	prawa right S301-094	140	100	45
wanna asymetryczna SICILIA 140 SICILIA 140 asymmetric bathtub	lewa left S301-093	140	100	45
panel czołowy SICILIA 140 SICILIA 140 front casing	S401-085	-	-	-
wanna asymetryczna SICILIA 150 SICILIA 150 asymmetric bathtub	prawa right S301-096	150	100	45
wanna asymetryczna SICILIA 150 SICILIA 150 asymmetric bathtub	lewa left S301-095	150	100	45
panel czołowy SICILIA 150 SICILIA 150 front casing	S401-086	-	-	-
wanna asymetryczna SICILIA 160 SICILIA 160 asymmetric bathtub	prawa right S301-037	160	100	45
wanna asymetryczna SICILIA 160 SICILIA 160 asymmetric bathtub	lewa left S301-036	160	100	45
panel czołowy SICILIA 160 SICILIA 160 front casing	S401-039	-	-	-
wanna asymetryczna SICILIA 170 SICILIA 170 asymmetric bathtub	prawa right S301-098	170	100	45
wanna asymetryczna SICILIA 170 SICILIA 170 asymmetric bathtub	lewa left S301-097	170	100	45
panel czołowy SICILIA 170 SICILIA 170 front casing	S401-087	-	-	-

VENUS >

Wanna
symetryczna
VENUS 140
**VENUS 140
symmetric
bathtub**
140x140 cm

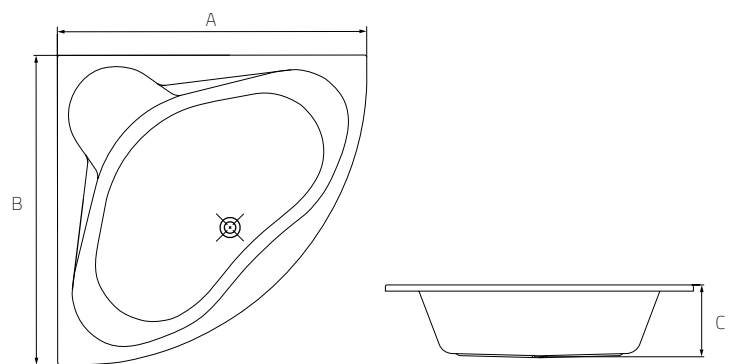

		A (cm)	B (cm)	C (cm)
wanna symetryczna VENUS 140 VENUS 140 symmetric bathtub	S301-038	140	140	46
panel czołowy VENUS 140 VENUS 140 front casing	S401-040	-	-	-
wanna symetryczna VENUS 150 VENUS 150 symmetric bathtub	S301-013	150	150	46
panel czołowy VENUS 150 VENUS 150 front casing	S401-013	-	-	-

WANNY BATHTUBS

FLAVIA >

Wanna
prostokątna
FLAVIA 160
FLAVIA 160
rectangular
bathtub
160x70 cm

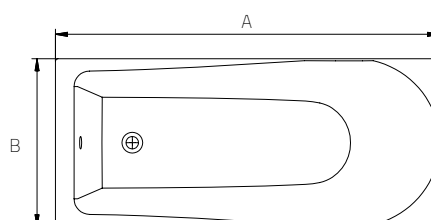

		A (cm)	B (cm)	C (cm)
wanna prostokątna FLAVIA 140 FLAVIA 140 rectangular bathtub	S301-104	140	70	42
panel czołowy LORENA 140 LORENA 140 front casing	S401-066	-	-	-
wanna prostokątna FLAVIA 150 FLAVIA 150 rectangular bathtub	S301-105	150	70	42
panel czołowy LORENA 150 LORENA 150 front casing	S401-067	-	-	-
wanna prostokątna FLAVIA 160 FLAVIA 160 rectangular bathtub	S301-106	160	70	42
panel czołowy LORENA 160 LORENA 160 front casing	S401-068	-	-	-
wanna prostokątna FLAVIA 170 FLAVIA 170 rectangular bathtub	S301-107	170	70	42
panel czołowy LORENA 170 LORENA 170 front casing	S401-069	-	-	-
panel boczny LORENA LORENA side casing	S401-071	-	-	-

NIKE

Wanna
prostokątna
NIKE
**NIKE
rectangular
bathtub**
150x70 cm.

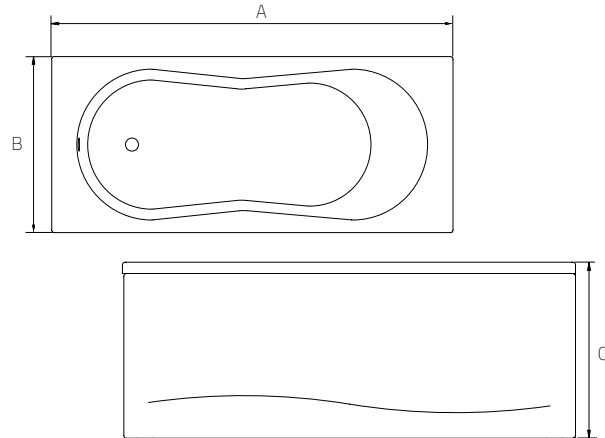

		A (cm)	B (cm)	C (cm)
wanna prostokątna NIKE 140 NIKE 140 bathtub rectangular	S301-026	140	70	46
panel czołowy NIKE 140 NIKE 140 front casing	S401-027	-	-	-
wanna prostokątna NIKE 150 NIKE 150 rectangular bathtub	S301-027	150	70	46
panel czołowy NIKE 150 NIKE 150 front casing	S401-028	-	-	-
wanna prostokątna NIKE 160 NIKE 160 rectangular bathtub	S301-028	160	70	46
panel czołowy NIKE 160 NIKE 160 front casing	S401-029	-	-	-
wanna prostokątna NIKE 170 NIKE 170 rectangular bathtub	S301-029	170	70	46
panel czołowy NIKE 170 NIKE 170 front casing	S401-030	-	-	-
panel boczny NIKE NIKE side casing NIKE	S401-031	-	-	-

OCTAVIA >

Wanna
prostokątna
OCTAVIA 150
**OCTAVIA 150
rectangular
bathtub**
150x70 cm

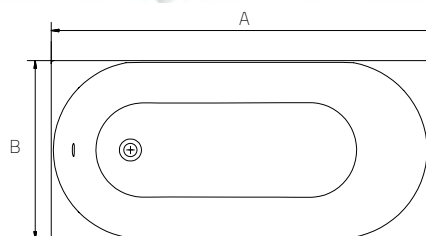

		A (cm)	B (cm)	C (cm)
wanna prostokątna OCTAVIA 140 OCTAVIA 140 rectangular bathtub	S301-108	140	70	43
panel czołowy LORENA 140 LORENA 140 front casing	S401-066	-	-	-
wanna prostokątna OCTAVIA 150 OCTAVIA 150 rectangular bathtub	S301-109	150	70	43
panel czołowy LORENA 150 LORENA 150 front casing	S401-067	-	-	-
wanna prostokątna OCTAVIA 160 OCTAVIA 160 rectangular bathtub	S301-110	160	70	43
panel czołowy LORENA 160 LORENA 160 front casing	S401-068	-	-	-
wanna prostokątna OCTAVIA 170 OCTAVIA 170 rectangular bathtub	S301-111	170	70	43
panel czołowy LORENA 170 LORENA 170 front casing	S401-069	-	-	-
panel boczny LORENA LORENA side casing	S401-071	-	-	-

SANTANA >

Wanna
prostokątna
SANTANA 160
SANTANA 160
rectangular
bathtub
160x70 cm

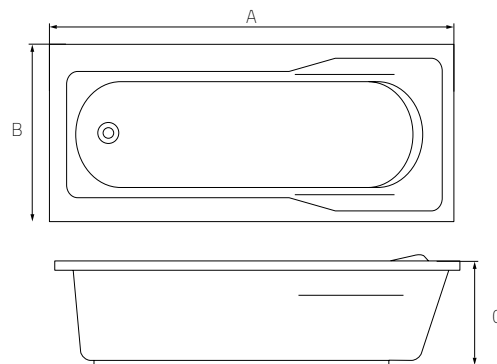

		A (cm)	B (cm)	C (cm)
wanna prostokątna SANTANA 140 SANTANA 140 rectangular bathtub	S301-033	140	70	42
panel czołowy SANTANA 140 SANTANA 140 front casing	S401-035	-	-	-
wanna prostokątna SANTANA 150 SANTANA 150 rectangular bathtub	S301-034	150	70	42
panel czołowy SANTANA 150 SANTANA 150 front casing	S401-036	-	-	-
wanna prostokątna SANTANA 160 SANTANA 160 rectangular bathtub	S301-044	160	70	42
panel czołowy SANTANA 160 SANTANA 160 front casing	S401-001	-	-	-
wanna prostokątna SANTANA 170 SANTANA 170 rectangular bathtub	S301-035	170	70	42
panel czołowy SANTANA 170 SANTANA 170 front casing	S401-037	-	-	-
panel boczny SANTANA SANTANA side casing	S401-038	-	-	-

KALIOPE >

Wanna
asymetryczna
prawa/lewa
KALIOPE 153
**KALIOPE 153
asymmetric
bathtub
right/left**
153×100 cm

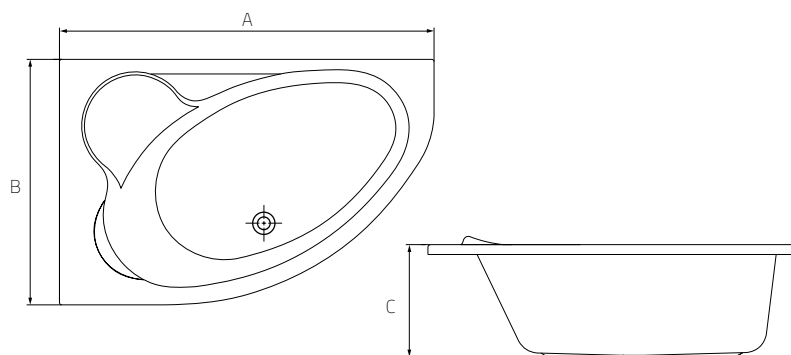

		A (cm)	B (cm)	C (cm)
wanna asymetryczna KALIOPE 153 KALIOPE 153 asymmetric bathtub	prawa right S301-025	153	100	46
wanna asymetryczna KALIOPE 153 KALIOPE 153 asymmetric bathtub	lewa left S301-024	153	100	46
panel czołowy prawy/lewy KALIOPE 153 KALIOPE 153 front casing right/left	prawy right S401-059	-	-	-
panel czołowy prawy/lewy KALIOPE 153 KALIOPE 153 front casing right/left	lewy left S401-059	-	-	-
wanna asymetryczna KALIOPE 170 KALIOPE 170 asymmetric bathtub	prawa right S301-115	170	110	46
wanna asymetryczna KALIOPE 170 KALIOPE 170 asymmetric bathtub	lewa left S301-114	170	110	46
panel czołowy KALIOPE 170 KALIOPE 170 front casing right/left	prawy right S401-29	-	-	-
panel czołowy KALIOPE 170 KALIOPE 170 front casing right/left	lewy left S401-095	-	-	-

NANO >

Wanna
asymetryczna
prawa/lewa
NANO 140
**NANO 140
asymmetric
bathtub
right/left**
140×75 cm

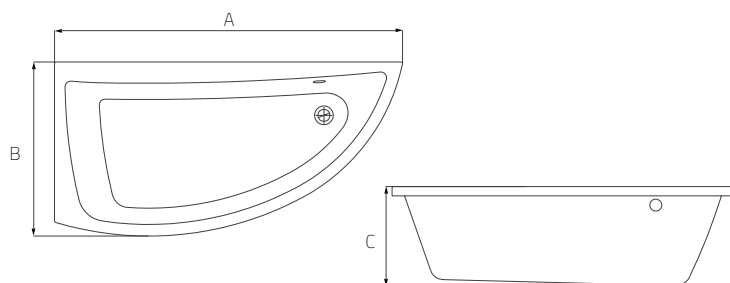

		A (cm)	B (cm)	C (cm)
wanna asymetryczna NANO 140 NANO 140 asymmetric bathtub	prawa right S301-061	140	75	43
wanna asymetryczna NANO 140 NANO 140 asymmetric bathtub	lewa left S301-062	140	75	43
panel czołowy NANO 140 NANO 140 front casing	prawy right S401-060	-	-	-
panel czołowy NANO 140 NANO 140 front casing	lewy left S401-061	-	-	-
wanna asymetryczna NANO 150 NANO 150 asymmetric bathtub	prawa right S301-063	150	75	43
wanna asymetryczna NANO 150 NANO 150 asymmetric bathtub	lewa left S301-064	150	75	43
panel czołowy NANO 150 NANO 150 front casing	prawy right S401-062	-	-	-
panel czołowy NANO 150 NANO 150 front casing	lewy left S401-063	-	-	-

ARIZA >

Wanna
asymetryczna
prawa/lewa
ARIZA 140
**ARIZA 140
bathtub
asymmetric
prawa/lewa**
140x85 cm

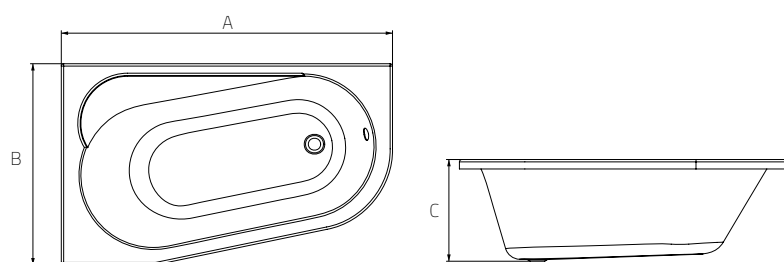

		A (cm)	B (cm)	C (cm)
wanna asymetryczna ARIZA 140 ARIZA 140 asymmetric bathtub	prawa right S301-059 lewa left S301-060	140	85	43
panel czołowy ARIZA 140 ARIZA 140 front casing	prawy right S401-057 lewy left S401-058	-	-	-
wanna asymetryczna ARIZA 150 ARIZA 150 asymmetric bathtub	prawa right S301-090 lewa left S301-089	150	90	42
panel czołowy ARIZA 150 ARIZA 150 front casing	prawy right S401-092 lewy left S401-090	-	-	-
wanna asymetryczna ARIZA 160 ARIZA 160 asymmetric bathtub	prawa right S301-092 lewa left S301-091	160	90	42
panel czołowy ARIZA 160 ARIZA 160 front casing	prawy right S401-093 lewy left S401-091	-	-	-

JOANNA >

Wanna
asymetryczna
prawa/lewa
JOANNA 140
JOANNA 140
bathtub
asymmetric
prawa/lewa
140x90 cm

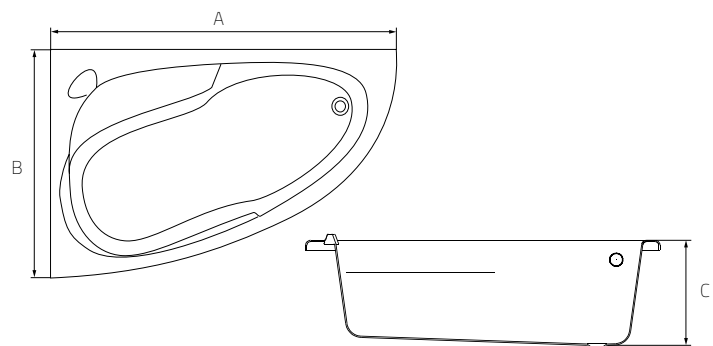

		A (cm)	B (cm)	C (cm)
wanna asymetryczna JOANNA 140 JOANNA 140 asymmetric bathtub	prawa right S301-006 lewa left S301-005	140	90	42
panel czołowy JOANNA 140 JOANNA 140 front casing	prawy right S401-022 lewy left S401-021	-	-	-
wanna asymetryczna JOANNA 150 JOANNA 150 asymmetric bathtub	prawa right S301-008 lewa left S301-007	150	95	42
panel czołowy JOANNA 150 JOANNA 150 front casing	prawy right S401-024 lewy left S401-023	-	-	-
wanna asymetryczna JOANNA 160 JOANNA 160 asymmetric bathtub	prawa right S301-112 lewa left S301-113	160	95	42
panel czołowy JOANNA 160 prawy/lewy JOANNA 160 front casing right/left	S401-094	-	-	-

CleanPro

niewidzialna powłoka,
ograniczająca osadzanie się ka-
mienia i brudu / **invisible coating,**
limiting deposition of both scale
and dirt

EASY >

Parawan na-
wannowy jed-
noskrzydłowy
EASY

**Single panel
bath screen**

EASY

70 x140cm

NOWOŚĆ / NEW

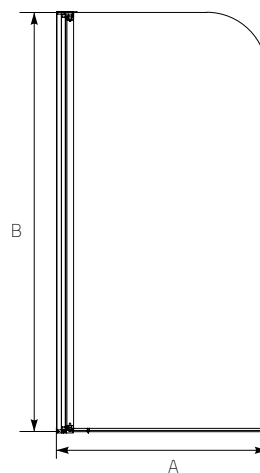

CleanPro

niewidzialna powłoka,
ograniczająca osadzanie się ka-
mienia i brudu / **invisible coating,**
limiting deposition of both scale
and dirt

EASY >

Parawan
nawannowy
dwuskrzydłowy
EASY
**Double panel
bath screen**
EASY
115 x140cm

NOWOŚĆ / NEW

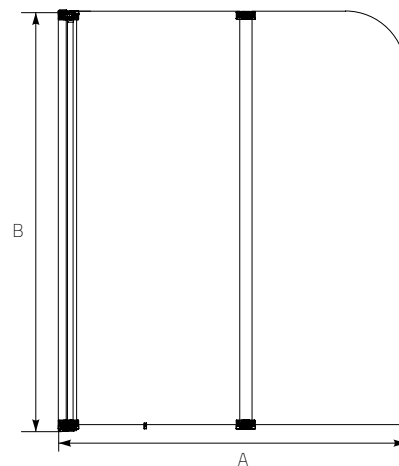

		A (cm)	B (cm)	C (cm)
Parawan nawannowy jednoskrzydłowy EASY EASY Single panel bath screen	S623-001	70	140	-
Parawan nawannowy dwuskrzydłowy EASY EASY Double panel bath screen	S623-002	115	140	-



KABINY
BRODZIKI
SHOWER
ENCLOSURES
SHOWER
TRAYS

N^o 2

**KABINY
BRODZIKI
SHOWER
ENCLOSURES
SHOWER
TRAYS**



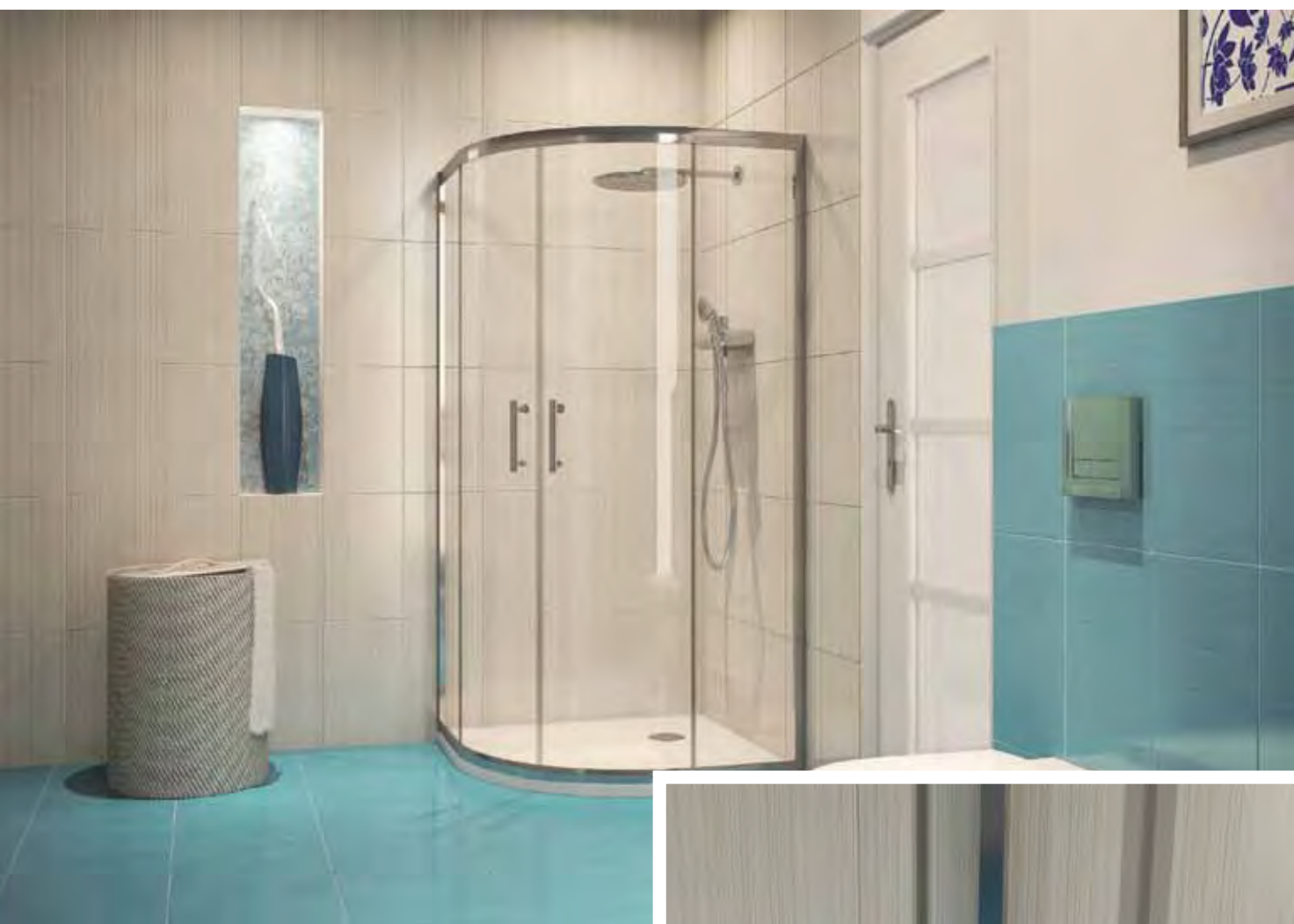

Kabiny: Onega, Ineba
Płytki: Oxia, Euforia
Shower enclosures: Onega, Ineba
Ceramic tiles: Oxia, Euforia



**KABINY
BRODZIKI
SHOWER
ENCLOSURES
SHOWER
TRAYS**

NAMA >

Kabina półokrągła NAMA
NAMA
halfround shower enclosure
Profil chromowany
190x80x80 cm
szkło brąz.
Chrome profile with brown glass



Kabina półokrągła NAMA
NAMA
halfround shower enclosure
profil chromowany
190x80x80 cm
szkło transparentne.
Chrome profile with transparent glass.



		A (cm)	B (cm)	C (cm)
kabina półokrągła NAMA szkło transparentne NAMA halfround shower enclosure transparent glass	S148-001	80	80	190
kabina półokrągła NAMA szkło transparentne NAMA halfround shower enclosure transparent glass	S148-002	90	90	190
kabina półokrągła NAMA szkło brąz NAMA halfround shower enclosure brown glass	S148-003	80	80	190
kabina półokrągła NAMA szkło brąz NAMA halfround shower enclosure brown glass	S148-004	90	90	190

ONEGA >

Kabina półokrągła ONEGA

ONEGA halfround shower enclosure

Profil chromowany
190×80×80 cm
szkło transparentne.

Chrome profile with transparent glass.



Kabina kwadratowa ONEGA

ONEGA Shower enclosure

profil chromowany
190×80×80 cm
szkło brąz.

Chrome profile with brown glass.



		A (cm)	B (cm)	C (cm)
kabina półokrągła ONEGA szkło transparentne ONEGA halfround shower enclosure transparent glass	S151-001	80	80	190
kabina półokrągła ONEGA szkło transparentne ONEGA halfround shower enclosure transparent glass	S151-002	90	90	190
kabina półokrągła ONEGA szkło brąz ONEGA halfround shower enclosure brown glass	S151-003	80	80	190
kabina półokrągła ONEGA szkło brąz ONEGA halfround shower enclosure brown glass	S151-004	90	90	190
kabina kwadratowa ONEGA szkło transparentne ONEGA square shower enclosure transparent glass	S151-007	80	80	190
kabina kwadratowa ONEGA szkło transparentne ONEGA square shower enclosure transparent glass	S151-008	90	90	190
kabina kwadratowa ONEGA szkło brąz ONEGA square shower enclosure brown glass	S151-005	80	80	190
kabina kwadratowa ONEGA szkło brąz ONEGA square shower enclosure brown glass	S151-006	90	90	190

KABINY BRODZIKI SHOWER ENCLOSURES SHOWER TRAYS

SAONA >

Kabina półokrągła SAONA
SAONA halfround shower enclosure
 Profil chromowany
 180×80×80 cm
 szkło tkanina.
 Chrome profile
 with fabric
 pattern glass



		A (cm)	B (cm)	C (cm)
kabina półokrągła SAONA szkło tkanina SAONA halfround shower enclosure fabric pattern glass	S149-001	80	80	180
kabina półokrągła SAONA szkło tkanina SAONA halfround shower enclosure fabric pattern glass	S149-002	90	90	180
kabina półokrągła SAONA szkło transparentne SAONA halfround shower enclosure transparent glass	S149-005	80	80	180
kabina półokrągła SAONA szkło transparentne SAONA halfround shower enclosure transparent glass	S149-006	90	90	180
kabina półokrągła SAONA szkło tkanina SAONA halfround shower enclosure fabric pattern glass	S149-003	80	80	167
kabina półokrągła SAONA szkło tkanina SAONA halfround shower enclosure fabric pattern glass	S149-004	90	90	167
kabina półokrągła SAONA szkło transparentne SAONA halfround shower enclosure transparent glass	S149-007	80	80	167
kabina półokrągła SAONA szkło transparentne SAONA halfround shower enclosure transparent glass	S149-008	90	90	167
kabina kwadratowa SAONA szkło tkanina SAONA square shower enclosure fabric pattern glass	S149-011	80	80	180
kabina kwadratowa SAONA szkło tkanina SAONA square shower enclosure fabric pattern glass	S149-012	90	90	180
kabina kwadratowa SAONA szkło transparentne SAONA square shower enclosure transparent glass	S149-009	80	80	180
kabina kwadratowa SAONA szkło transparentne SAONA square shower enclosure transparent glass	S149-010	90	90	180

INEBA >

Kabina półokrągła INEBA
INEBA halfround shower enclosure
Profil chromowany
185×80×80 cm
szkło mrożone – kółka.
Chrome profile with frosted glass-circles



Kabina kwadratowa INEBA
INEBA square shower enclosure
profil chromowany
185×80×80 cm
szkło grafit
Chrome profile with graphite glass



		A (cm)	B (cm)	C (cm)
kabina półokrągła INEBA szkło mrożone – kółka INEBA halfround shower enclosure with frosted glass-circles	S150-003	80	80	185
kabina półokrągła INEBA szkło mrożone – kółka INEBA halfround shower enclosure with frosted glass-circles	S150-004	90	90	185
kabina półokrągła INEBA szkło grafit INEBA halfround shower enclosure with frosted glass-circles	S150-001	80	80	185
kabina półokrągła INEBA szkło grafit INEBA halfround shower enclosure with frosted glass-circles	S150-002	90	90	185
kabina półokrągła INEBA szkło mrożone – kółka INEBA halfround shower enclosure with frosted glass-circles	S150-005	80	80	167
kabina półokrągła INEBA szkło mrożone – kółka INEBA halfround shower enclosure with frosted glass-circles	S150-006	90	90	167
kabina kwadratowa INEBA szkło grafit INEBA square shower enclosure with graphite glass	S150-007	80	80	185
kabina kwadratowa INEBA szkło grafit INEBA square shower enclosure with graphite glass	S150-008	90	90	185

**KABINY
BRODZIKI
SHOWER
ENCLOSURES
SHOWER
TRAYS**

TAKO

Brodzik
półokrągły
TAKO 80/3
TAKO 80/3
shower tray
80x80x3 cm

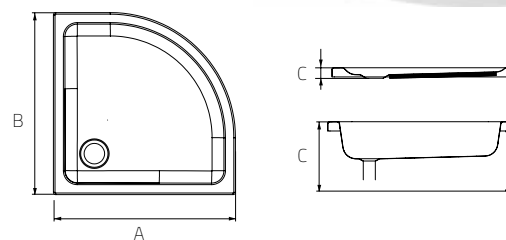

brodzik półokrągły
TAKO 80/16
TAKO 80/16
halfround
shower tray
80x80x16 cm



		A (cm)	B (cm)	C (cm)
brodzik półokrągły TAKO 80/3 TAKO 80/3 halfround shower tray	S204-001	80	80	4
brodzik półokrągły TAKO 90/3 TAKO 90/3 halfround shower tray	S204-002	90	90	4
brodzik półokrągły TAKO 80/6 zintegrowany z panelem TAKO 80/6 halfround shower tray integrated with casing	S204-003	80	80	7
brodzik półokrągły TAKO 90/6 zintegrowany z panelem TAKO 90/6 halfround shower tray integrated with casing	S204-004	90	90	7
brodzik półokrągły TAKO 80/16 TAKO 80/16 halfround shower tray	S204-005	80	80	17
panel do brodzika półokrągłego TAKO 80/16 TAKO 80/16 casing halfround shower tray	S402-008	-	-	17
brodzik półokrągły TAKO 90/16 TAKO 90/16 halfround shower tray	S204-006	90	90	17
panel do brodzika półokrągłego TAKO 90/16 TAKO 90/16 casing shower tray	S402-009	-	-	17
brodzik półokrągły TAKO 80/30 TAKO 80/30 halfround shower tray	S204-007	80	80	31
panel do brodzika półokrągłego TAKO 80/30 TAKO 80/30 shower tray panel	S402-010	-	-	31
brodzik półokrągły TAKO 90/30 TAKO 90/30 halfround shower tray	S204-008	80	80	31
panel do brodzika półokrągłego TAKO 90/30 TAKO 90/30 casing shower tray	S402-011	-	-	31

TAKO >

Brodzik kwadratowy TAKO 90/3
TAKO 90/3 square shower tray
 90x90x3 cm

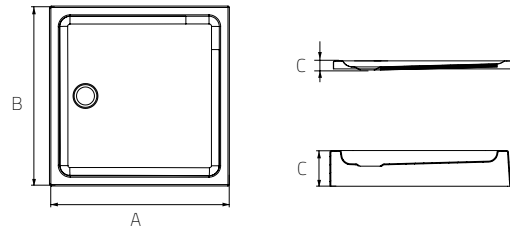

brodzik kwadratowy TAKO 80/6 zintegrowany z panelem
TAKO 80/6 square shower tray integrated with casing
 80x80x6 cm



		A (cm)	B (cm)	C (cm)
brodzik kwadratowy TAKO 80/3 TAKO 80/3 square shower tray	S204-009	80	80	4
brodzik kwadratowy TAKO 90/3 TAKO 90/3 square shower tray	S204-010	90	90	4
brodzik kwadratowy TAKO 80/6 zintegrowany z panelem TAKO 80/6 square shower tray integrated with casing	S204-011	80	80	7
brodzik kwadratowy TAKO 90/6 zintegrowany z panelem TAKO 90/6 square shower tray integrated with casing	S204-012	90	90	7
brodzik kwadratowy TAKO 80/16 TAKO 80/16 square shower tray	S204-013	80	80	17
brodzik kwadratowy TAKO 90/16 TAKO 90/16 square shower tray	S204-014	90	90	17

INFORMACJE TECHNICZNE TECHNICAL INFORMATION









PŁYTKI ŚCIENNE WALL TILES

CHARAKTERYSTYKA TECHNICZNA PŁYTEK CERAMICZNYCH ŚCIENNYCH

Płytki ceramiczne ściennie posiadają parametry zgodne z normą PN-EN 14411 wg załącznika L „Płytki ceramiczne prasowane na sucho” E>10%, Grupa B III GL

TECHNICAL SPECIFICATION OF CERAMIC WALL TILES

The ceramic wall tiles are manufactured in accordance with the PN-EN 14411 standard as described in Appendix L, “Dry-pressed ceramic tiles” E>10%, Group B III GL.

Właściwości Properties	Badanie wg: Test made acc. to:	Wymagania Requirements	Parametry płytek Tiles parameters
 Nasiąkliwość wodna (%) Permeability to water (%)	PN-EN ISO 10545-3	> 10	> 10
 Wytrzymałość na zginanie (MPa) Bending strength (MPa)	PN-EN ISO 10545-4	≥ 7,5 mm; min. 15 < 7,5 mm; min. 12	min. 15
 Siła łamiąca (N) Breaking strength (N)	PN-EN ISO 10545-4	≥ 7,5 mm: min. 600 < 7,5 mm: min. 200	≥ 7,5 mm: min. 800 < 7,5 mm: min. 400
 Odporność na pęknięcia włoskowate Crazing resistance	PN-EN ISO 10545-11	required / wymagana	resistant / odporne
 Współczynnik cieplnej rozszerzalności liniowej (10 ⁻⁶ /°C) Coefficient of linear thermal expansion (10 ⁻⁶ /°C)	PN-EN ISO 10545-8	s.m.b. *	<9
 Odporność na kwasy i zasady o słabym stężeniu Resistance to weak solutions of acids and alkali	PN-EN ISO 10545-13	s.m.b. *	GLA-GLB
 Odporność na działanie środków domowego użytku i soli do basenów kąpielowych Resistance to household chemicals and swimming-pool salts	PN-EN ISO 10545-13	min. GB	GA
 Odporność na plamienie Resistance to stains	PN-EN ISO 10545-14	min. klasa 3	5 klasa

* stosowana metoda badania
* method of testing used











PŁYTKI PODŁOGOWE FLOOR TILES

CHARAKTERYSTYKA TECHNICZNA PŁYTEK CERAMICZNYCH PODŁOGOWYCH

Płytki ceramiczne podłogowe posiadają parametry zgodne z normą PN-EN 14411, wg załącznika J „Płytki ceramiczne prasowane na sucho” $3 < E \leq 6\%$, Grupa B IIa GL.

TECHNICAL SPECIFICATION OF CERAMIC FLOOR TILES

Ceramic floor tiles are manufactured in accordance with the PN-EN 14411 standard as described in Appendix J, “Dry-pressed ceramic tiles” $3 < E \leq 6\%$, Group B IIa GL.

Właściwości Properties	Badanie wg: Test made acc. to:	Wymagania Requirements	Parametry płytek Tiles parameters
 Nasiąkliwość wodna (%) Permeability to water (%)	PN-EN ISO 10545-3	$3 < E \leq 6$	4
 Wytrzymałość na zginanie (MPa) Bending strength (MPa)	PN-EN ISO 10545-4	min. 22	min. 35
 Siła łamiąca (N) Breaking strength (N)	PN-EN ISO 10545-4	$\geq 7,5$ mm: min. 1000 $< 7,5$ mm: min. 600	$\geq 7,5$ mm: min. 1300 $< 7,5$ mm: min. 1000
 Odporność na pęknięcia włoskowate Crazing resistance	PN-EN ISO 10545-11	wymagana / required	odporne / resistant
 Współczynnik cieplnej rozszerzalności liniowej ($10^{-6}/^{\circ}\text{C}$) Coefficient of linear thermal expansion ($10^{-6}/^{\circ}\text{C}$)	PN-EN ISO 10545-8	s.m.b. *	< 9
 Odporność na ścieranie (klasa) Abrasion resistance (class)	PN-EN ISO 10545-7	nominal / deklarowana	2-5
 Skuteczność antypoślizgowa (grupa klasyfikacyjna) Slip resistance (classification group)	DIN 51130	wg deklaracji / as declared	NPD
 Odporność na kwasy i zasady o słabym stężeniu Resistance to weak solutions of acids and alkali	PN-EN ISO 10545-13	s.m.b. *	GLA-GLB
 Odporność na działanie środków domowego użytku i soli do basenów kąpielowych Resistance to household chemicals and swimming-pool salts	PN-EN ISO 10545-13	min. GB	GA
 Odporność na plamienie Resistance to stains	PN-EN ISO 10545-14	min. 3 klasa	5 klasa

* stosowana metoda badania
* method of testing used

INFORMACJE TECHNICZNE TECHNICAL INFORMATION











GRES NIESZKLIWIONY UNGLAZED PORCELAIN TILES

CHARAKTERYSTYKA TECHNICZNA PŁYTEK GRES NIESZKLIWIONY

Płytki gres nieszkliwione posiadają parametry zgodne z normą PN-EN 14411, wg załącznika G, „Płytki ceramiczne prasowane na sucho o małej nasiąkliwości wodnej” $E \leq 0,5\%$, Grupa B la UGL.

TECHNICAL SPECIFICATION OF UNGLAZED PORCELAIN TILES

The unglazed porcelain tiles are manufactured in accordance with the PN-EN 14411 standard as described in Appendix G “Low water absorbability dry-pressed ceramic tiles” $E \leq 0.5\%$, Group B la UGL.

Właściwości Properties	Badanie wg: Test made acc. to:	Wymagania Requirements	Parametry płytek Tiles parameters
 Nasiąkliwość wodna (%) Permeability to water (%)	PN-EN ISO 10545-3	$E \leq 0.5$	0.1
 Wytrzymałość na zginanie (MPa) Bending strength (MPa)	PN-EN ISO 10545-4	min. 35	min. 40 min. 50 (dla płytek 200x200x12)
 Siła łamiąca (N) Breaking strength (N)	PN-EN ISO 10545-4	< 7,5 mm: min. 700 ≥ 7,5 mm: min. 1300	< 7,5 mm: min. 1300 ≥ 7,5 mm: min. 1800 ≥ 12 mm: min. 5000
 Współczynnik cieplnej rozszerzalności liniowej ($10^{-6}/^{\circ}\text{C}$) Coefficient of linear thermal expansion ($10^{-6}/^{\circ}\text{C}$)	PN-EN ISO 10545-8	s.m.b. *	<9
 Mrozoodporność Frost resistance	PN-EN ISO 10545-12	wymagana / required	mrozoodporność / frost resistance
 Odporność na ścieranie wgłębne (mm ³) Deep scratch resistance (mm ³)	PN-EN ISO 10545-6	max. 175	max. 130
 Skuteczność antypoślizgowa (grupa klasyfikacyjna) Slip resistance (classification group)	DIN 51130	wg deklaracji / as declared	NPD, R9, R10, R11, R12
 Odporność na kwasy i zasady o słabym stężeniu Resistance to weak solutions of acids and alkali	a) PN-EN ISO 10545-13 b) PN-EN ISO 10545-13	s.m.b. * s.m.b. *	ULA-ULB UHA-UHB
 Odporność na działanie środków domowego użytku i soli do basenów kąpielowych Resistance to household chemicals and swimming-pool salts	PN-EN ISO 10545-13	min. UB	GA
 Odporność na plamienie Resistance to stains	PN-EN ISO 10545-14	s.m.b. *	klasa (3-5) polerowane (2-5)

* stosowana metoda badania
* method of testing used











GRES SZKLIWIONY GLAZED PORCELAIN TILES

CHARAKTERYSTYKA TECHNICZNA PŁYTEK I LISTEW GRES SZKLIWIONY

Płytki i listwy gres szklwione posiadają parametry zgodne z normą PN-EN 14411, wg załącznika G „Płytki ceramiczne prasowane na sucho o małej nasiąkliwości wodnej” $E \leq 0,5\%$, Grupa B la GL.

TECHNICAL SPECIFICATION OF GLAZED PORCELAIN TILES AND BORDERS.

Glazed porcelain tiles and borders are manufactured in accordance, with the PN-EN 14411 standard as described in Appendix G “Low water absorbability dry-pressed ceramic tiles” $E \leq 0,5\%$, Group B la GL.

Właściwości Properties	Badanie wg: Test made acc. to:	Wymagania Requirements	Parametry płytek Tiles parameters
 Nasiąkliwość wodna (%) Permeability to water (%)	PN-EN ISO 10545-3	$E \leq 0.5$	0.1
 Wytrzymałość na zginanie (MPa) Bending strength (MPa)	PN-EN ISO 10545-4	min. 35	min. 40
 Siła łamiąca (N) Breaking strength (N)	PN-EN ISO 10545-4	< 7,5 mm: min. 700 ≥ 7,5 mm: min. 1300	< 7,5 mm: min. 1300 ≥ 7,5 mm: min. 1800
 Odporność na pęknięcia włoskowate Crazing resistance	PN-EN ISO 10545-11	wymagana / required	odporne / resistant
 Współczynnik cieplnej rozszerzalności liniowej ($10^{-6}/^{\circ}\text{C}$) Coefficient of linear thermal expansion ($10^{-6}/^{\circ}\text{C}$)	PN-EN ISO 10545-8	s.m.b. *	<9
 Mrozoodporność Frost resistance	PN-EN ISO 10545-12	wymagana / required	mrozoodporność / frost resistance
 Odporność na ścieranie (klasa) Abrasion resistance (class)	PN-EN ISO 10545-7	deklarowana / nominal	2-5
 Skuteczność antypoślizgowa (grupa klasyfikacyjna) Slip resistance (classification group)	DIN 51130	wg deklaracji / as declared	NPD, R9, R10, R11
 Odporność na kwasy i zasady o słabym stężeniu Resistance to weak solutions of acids and alkali	PN-EN ISO 10545-13	s.m.b. *	GLA-GLB
 Odporność na działanie środków domowego użytku i soli do basenów kąpielowych Resistance to household chemicals and swimming-pool salts	PN-EN ISO 10545-13	min. GB	GA
 Odporność na plamienie Resistance to stains	PN-EN ISO 10545-14	min. 3 klasa	5 klasa

* stosowana metoda badania
* method of testing used











PŁYTKI KLINKIEROWE NIESZKLIWIONE SIMPLE, SHADOW
UNGLAZED CLINKER TILES SIMPLE, SHADOW

CHARAKTERYSTYKA TECHNICZNA PŁYTEK KLINKIEROWYCH

Płytki klinkierowe posiadają parametry zgodne z normą PN-EN 14411, wg załącznika H, „Płytki ceramiczne prasowane na sucho o małej nasiąkliwości wodnej” $0,5\% < E < 3\%$ Grupa BIb, uGL

TECHNICAL SPECIFICATION OF CLINKER

The clinker tiles are manufactured in accordance with the PN-EN 14411 standard as described in Appendix H “Low water absorbability dry-passed ceramic tiles” $0,5\% < E < 3\%$ Group BIb

Właściwości Properties	Badanie wg: Test made acc. to:	Wymagania Requirements	Parametry płytek Tiles parameters
 Nasiąkliwość wodna (%) Permeability to water (%)	PN-EN ISO 10545-3	$0,5\% < E \leq 3\%$	0,5 – 2
 Wytrzymałość na zginanie (MPa) Bending strength (MPa)	PN-EN ISO 10545-4	min. 30	> 40
 Siła łamiąca (N) Breaking strength (N)	PN-EN ISO 10545-4	< 7,5 mm: min. 700 ≥ 7,5 mm: min. 1100	> 1300 > 2600
 Współczynnik cieplnej rozszerzalności liniowej ($10^{-6}/^{\circ}\text{C}$) Coefficient of linear thermal expansion ($10^{-6}/^{\circ}\text{C}$)	PN-EN ISO 10545-8	s.m.b. *	<9
 Mrozoodporność Frost resistance	PN-EN ISO 10545-12	wymagana / required	mrozoodporność / frost resistance
 Odporność na ścieranie wgłębne (mm ³) Deep scratch resistance (mm ³)	PN-EN ISO 10545-6	max. 175	140
 Skuteczność antypoślizgowa (grupa klasyfikacyjna) Slip resistance (classification group)	DIN 51130	wg deklaracji / as declared	R9 – płytki gładkie R9 – smooth tiles R10 – płytki strukturalne (3-d) R10 – structure tiles
 Odporność na odczynniki chemiczne: a) na kwasy i zasady o słabym natężeniu, b) na kwasy i zasady o mocnym stężeniu Resistance to chemicals: a) weak solutions of acids and alkali, b) potent solutions of acids and alkali	PN-EN ISO 10545-13	s.m.b. *	ULA-ULB UHA-UHB
 Odporność na działanie środków domowego użytku i soli do basenów kąpielowych Resistance to household chemicals and swimming-pool salts	PN-EN ISO 10545-13	min. UB	UA
 Odporność na plamienie Resistance to stains	PN-EN ISO 10545-14	s.m.b. *	3 – 5 klasa

* stosowana metoda badania
* method of testing used











PŁYTKI KLINKIEROWE SZKLIWIONE SOLAR GLAZED CLINKER TILES SOLAR

CHARAKTERYSTYKA TECHNICZNA PŁYTEK KLINKIEROWYCH SZKLIWIONYCH

Płytki klinkierowe posiadają parametry zgodne z normą PN-EN 14411, wg załącznika H,
„Płytki ceramiczne prasowane na sucho o małej nasiąkliwości wodnej” $0,5\% < E < 3\%$ Grupa Blb, GL

TECHNICAL SPECIFICATION OF GLAZED CLINKER

The clinker tiles are manufactured in accordance with the PN-EN 14411 standard as described in Appendix H
“Low water absorbability dry-passed ceramic tiles” $0,5\% < E < 3\%$ Group Blb, GL

Właściwości Properties	Badanie wg: Test made acc. to:	Wymagania Requirements	Parametry płytek Tiles parameters
 Nasiąkliwość wodna (%) Permeability to water (%)	PN-EN ISO 10545-3	$0,5\% < E \leq 3\%$	0,5 – 2,5
 Wytrzymałość na zginanie (MPa) Bending strength (MPa)	PN-EN ISO 10545-4	min. 30; pojedynczy min. 27	min. 40
 Siła łamiąca (N) Breaking strength (N)	PN-EN ISO 10545-4	< 7,5 mm: min. 700 ≥ 7,5 mm: min. 1100	> 1300 > 2600
 Odporność na pęknięcia włoskowate Crazing resistance	PN-EN ISO 10545-11	wymagana / required	resistant / odporne
 Mrozoodporność Frost resistance	PN-EN ISO 10545-12	wymagana / required	mrozoodporność / frost resistance
 Współczynnik cieplnej rozszerzalności liniowej ($10^{-6}/^{\circ}\text{C}$) Coefficient of linear thermal expansion ($10^{-6}/^{\circ}\text{C}$)	PN-EN ISO 10545-8	s.m.b. *	<9
 Odporność na ścieranie (klasa) Abrasion resistance (class)	PN-EN ISO 10545-7	nominal / deklarowana	3-4
 Skuteczność antypoślizgowa (grupa klasyfikacyjna) Slip resistance (classification group)	DIN 51130	s.m.b. *	R10
 Odporność na kwasy i zasady o słabym stężeniu Resistance to weak solutions of acids and alkalis	PN-EN ISO 10545-13	1. nominal / deklarowana *	1. GLA, GLB 2. GHA, GHB
 Odporność na działanie środków domowego użytku i soli do basenów kąpielowych Resistance to household chemicals and swimming-pool salts	PN-EN ISO 10545-13	min. GB	GA
 Odporność na plamienie Resistance to stains	PN-EN ISO 10545-14	s.m.b. *	5 klasa

* stosowana metoda badania
* method of testing used

ZASADY DOBORU PŁYTEK

Dokonując wyboru płytek, oprócz walorów estetycznych, należy wziąć pod uwagę przede wszystkim szczególne warunki, w których płytka będzie eksploatowana. Jako okładziny ścian wewnętrznych można stosować wszystkie płytki marki Opoczno. Na pokrycia podłóg wewnątrz budynków należy stosować płytki podłogowe, gresowe lub płytki klinkierowe. Przy wyborze płytek na podłogę należy mieć na uwadze przewidywane natężenie ruchu i wybrać płytki o odpowiedniej odporności na ścieranie (płytki podłogowe szkliwione, gres szkliwiony). W miejscach gdzie zachodzi duże prawdopodobieństwo poślizgu stosuje się płytki posiadające cechy antypoślizgowe. Przy wyborze płytek polerowanych należy pamiętać o ich szczególnie śliskiej powierzchni. W pomieszczeniach z przewidywanym dużym natężeniem ruchu zalecamy stosowanie gresów nieszkliwionych. Na zewnątrz budynków stosujemy tylko płytki gresowe lub klinkierowe, które są odporne na działanie ujemnych temperatur.

TILE SELECTION CRITERIA

When selecting tiles, apart from attractive design, it is important to take into consideration specific conditions in which a tile is going to be used. All Opoczno tiles can be used as interior wall tiling. Floors inside buildings should be laid with floor tiles, stoneware or clinker tiles. When selecting floor tiles it is important to take into consideration predicted traffic volume and select tiles with appropriate wear resistance level (glazed floor tiles, glazed stoneware). Anti-slip floor tiles are used in places with a strong risk of slipping. When selecting polished tiles remember about their slippery surface. In rooms with predicted high traffic volume we recommend using unglazed stoneware tiles. Outside buildings we only use stoneware or clinker tiles, which are resistant to temperatures below zero degrees.

KLASA ŚCIERALNOŚCI

- 2 – produkt zalecany do pomieszczeń domowych o niskim natężeniu ruchu, np. łazienka
- 3 – produkt zalecany do pomieszczeń domowych o niskim i średnim natężeniu ruchu, typu łazienka, kuchnia, salon, przedpokój, taras
- 4 – produkt zalecany do stosowania w miejscach o normalnym natężeniu ruchu, np. budynki mieszkalne oraz użyteczności publicznej
- 5 – produkt zalecany do stosowania w miejscach wzmożonego natężenia ruchu, takich jak: centra handlowe, przejścia i korytarze, miejsca publiczne

ABRASION-RESISTANCE CLASS

- 2 – product recommended for house rooms with low intensity of traffic e.g. a bathroom
- 3 – product recommended for house rooms with low and medium intensity of traffic e.g. a bathroom, a kitchen, a living room, a hall or a terrace
- 4 – product recommended to be applied in places of normal intensity of traffic, e.g. residence buildings and public utility buildings
- 5 – product recommended to be applied in places of increased intensity of traffic, such as: shopping centres, passages and corridors, public places

ODCIEŃ PŁYTEK

ODCIEŃ – różnica w intensywności barwy poszczególnych dekoracji na płytce w stosunku do przyjętego wzorca. Dla gresu nieszkliwionego – różnica w ilości lub intensywności kolorowej bazy dająca zmianę wybarwienia całej powierzchni płytki w stosunku do wzorca. Oznaczenie odcienia znajduje się na każdym jednostkowym opakowaniu. Płytki przeznaczone do wyłożenia w jednym pomieszczeniu muszą zawierać takie same oznaczenia odcienia na wszystkich opakowaniach. Płytki ceramiczne oznaczone jednym odcieniem mogą posiadać niewielkie różnice grafiki wzoru i kolorystyki, wynikające z technologii produkcji. Gres nieszkliwiony polerowany i satynowany wyróżnia się niepowtarzalnością wzoru na poszczególnych płytkach. Może posiadać również niewielkie różnice barwy. Przed układaniem wszystkich ww. płytek sugeruje się rozłożenie płytek z różnych opakowań oraz ich wymieszanie. Efekt cieniowania w przypadku płytek rustykalnych jest zamierzony.

TILE SHADE

SHADE – a difference in the intensity of colours in individual decorations on a tile in proportion to the assumed pattern. Unglazed stoneware – a difference in the amount or colour intensity of the base, which results in the change of dyeing of the entire surface of the tile in proportion to the pattern. Shade designation is placed in every single box. Tiles to be laid in one room must have an identical shade designation on all boxes. Ceramic tiles marked with one shade may have slight differences in the pattern graphics and colouring caused by manufacturing technology. Polished unglazed and satin-finished stoneware is distinguished by the uniqueness of the pattern on the individual tiles. It also may have slight differences in colour. Before laying all the abovementioned tiles, it is recommended to spread the tiles from different boxes and mix them. Shading effect in the case of rustic tiles is intended.

ANTYPOŚLIZGOWOŚĆ

Jest to ważna cecha dla płytek, które stosuje się jako okładzinę podłogową w warunkach wymagających zwiększonej skuteczności przeciwpoślizgowej. Płytką, która ma powierzchnię strukturalną lub reliefową ma określoną skuteczność przeciwdziałania poślizgom. O tejże skuteczności informuje współczynnik R czyli kąt przy którym dochodzi do poślizgu (wg niemieckiej normy DIN 51130)

Zakres kąta – klasy antypoślizgowości

6-10 – klasa R9

10-19 – klasa R10

19-27 – klasa R11

27-35 – klasa R12

Powyżej 35 – klasa R13

Dodatkowo może być określana zdolność powierzchni reliefowych do zatrzymania części cieczy rozlanej na płytkę, we wgłębieniach na płytce. Zdolność ta określona jest w niemieckiej normie DIN 51130 jako objętość wgłębień w cm³, odniesiona do powierzchni 1 dm² płytki. Oznaczana jest literą V i liczbą (np. V4). Charakterystyka antypoślizgowa jest również określona w normie 51097 – przeciwpoślizgowość mokrych powierzchni po których chodzi się boso. Oznaczana jest literami A, B lub C.

ANTI-SLIP PROPERTIES

It is a very important feature of tiles, which are used as floor tiling in the where increased anti-slip efficiency is required. Tiles with structural or relief surface have specified anti-slip efficiency. This efficiency is defined by an R coefficient - an angle at which slipping occurs (according to German standard DIN 51130)

Angle range - Anti-slip classes

6-10 – class R9

10-19 – class R10

19-27 – class R11

27-35 – class R12

Above 35 - class R13

Additionally, the ability of the relief surface of tiles to retain in their cavities part of liquid spilled onto a tile, can be determined. This ability is defined in the German standard DIN 51130 as the volume of cavities in cm³ per 1 dm² of the tile and marked with the letter V and a number (e.g. V4).

Anti-slip properties are also defined in the standard DIN 51097 – anti-slip properties for wet surfaces for bare foot. They are marked with the letters A, B or C.

CHEMOODPORNOŚĆ

W warunkach szczególnych, gdzie istnieje prawdopodobieństwo rozlania substancji kwasowych lub zasadowych ważne jest aby płytka posiadała odporność chemiczną na tego rodzaju czynniki chemiczne. Wszystkie płytki marki Opoczno badane są pod kątem odporności na kwasy, zasady oraz składniki wody basenowej. Najwyższą odporność wykazują płytki gres szklwiony i nieszkliwiony - odporne są na działanie również mocnych roztworów kwasów i zasad wg PN-EN 10545-13. Parametr ten jest istotny przy układaniu płytek w zakładach przemysłowych, w przemyśle spożywczym, chemicznym, basenach kąpielowych.

CHEMICAL RESISTANCE

In specific conditions, with a risk of spilling acid or or base it is important that a tile is resistant to these chemicals. All Opoczno tiles are examined for acids, bases and pool water components. Glazed and unglazed stoneware tiles show best resistance - also resistance to strong solutions of acids and bases according to PN-EN 10545-13. This parameter is essential when laying tiles in industrial plants, in foodstuff and chemical industries or swimming pools.

MROZOODPORNOŚĆ

Jest to parametr określający odporność płytek ceramicznych na temperatury ujemne. Płytki w trakcie badania poddawane są 100 cyklom zamrażania i rozmrażania. W trakcie rozmrażania woda penetruje wgłąb płytki a w trakcie zamrażania zgromadzona woda w płytce zamarza zwiększając swoją objętość. Jeżeli płytka jest mocno spieczona tak jak gres lub klinkier to ilość zgromadzonej wody jest na tyle mała, że nie powoduje uszkodzenia płytki. Należy pamiętać, że sama mrozoodporność płytki w żadnym wypadku nie gwarantuje końcowego efektu, czyli trwałej układziny ceramicznej np na tarasie. O tym decyduje właściwe wykonanie prac montażowych i użycie odpowiednich materiałów budowlanych do montażu płytek na zewnątrz.

FROST RESISTANCE

This parameter specifies the resistance of ceramic tiles to negative temperatures. During the examination, tiles are subjected to 100 cycles of freezing and defrosting. While defrosting water penetrates a tile and while freezing water accumulated in a tile freezes and increases its volume. If a tile is sintered as hard as stoneware or clinker then the amount of accumulated water so low that it does not damage the tile. Remember that a tile's frost resistance by no means guarantee a final result - durable ceramic flooring, e.g. on a terrace. It is determined by proper installation works and using adequate construction materials for the installation of tiles outside.

NASIĄKLIWOŚĆ

Nasiąkliwość płytki to zdolność do pochłaniania i zatrzymywania wody. Jest to podstawowe kryterium dzielące płytki wg ich własności:

Grupa BIa – płytki gresowe o niskiej nasiąkliwości $E \leq 0,5\%$;

Grupa BIb – płytki klinkierowe o nasiąkliwości $0,5\% < E < 3\%$;

Grupa BIIa – płytki podłogowe o nasiąkliwości $3 < E < 6\%$;

Grupa BIII – płytki ścienne o nasiąkliwości $E > 10\%$.

Parametr nasiąkliwości jest ściśle związany ze strukturą wewnętrzną płytki wynikającą z technologii produkcji. Im mniej wolnych przestrzeni w strukturze płytki, tym mniejsza nasiąkliwość i lepsze parametry użytkowe płytki jak: wytrzymałość na złamanie, czy mrozoodporność. W warunkach użytkowania chłonność płytki może być zmniejszona przez zastosowanie odpowiednich fug. Pochłanianie wody w płytkach szkliwionych następuje jedynie od strony nie pokrytej szkliwem.

ABSORBABILITY

Tile absorbability is a capacity to absorb and retain water. It is a basic criterion, which divides tiles according to their properties:

Group BIa - stoneware tiles with low absorbability of $E \leq 0.5\%$;

Group BIb - clinker tiles with absorbability of $0.5\% < E < 3\%$;

Group BIIa - floor tiles with absorbability of $3 < E < 6\%$;

Group BIII - floor tiles with absorbability of $E > 10\%$.

Tile absorbability parameter is closely linked to the tile's internal structure resulting from manufacturing technology. The less free spaces in the structure of the tile, the less absorbability and better operating parameters of the tile, such as: fracture resistance, frost resistance. In operating conditions, the absorbing capacity of the tile can be decreased by: the application of adequate joints. Water absorption in glazed tiles takes place only from the side, which is not glazed.

REKTYFIKACJA

Proces rektyfikacji jest mechaniczną obróbką boków płytek i polega na bardzo dokładnym docięciu ich brzegów pod określony wymiar, zwykle z dokładnością do $\pm 0,3$ mm. Płytki rektyfikowane cechują się zdecydowanie większą dokładnością wymiarową niż płytki nierektyfikowane – sortowane na grupy wymiarowe. Niewielkie różnice wymiarowe pomiędzy płytkami rektyfikowanymi pozwalają na zastosowanie minimalnych fug pomiędzy płytkami tj. 1 mm.

RECTIFICATION

Rectification is a mechanical treatment of tile sides and consists in very accurate cutting of their edges to a specified size, usually to within ± 0.3 mm. Rectified tiles are characterized by decidedly better size accuracy than non-rectified tiles sorted into size groups. Slight size differences between rectified tiles allow you to use minimum joints between tiles, i.e. 1 mm.

FUGI

Spoina, jest estetycznym dopełnieniem ceramicznej lub kamiennej posadzki. Fuga stanowi również swoistą dylatację pomiędzy płytkami, pozwalająca na ich minimalne odkształcenia, zwłaszcza gdy praca podłoża prowadzi do wystąpienia naprężeń np. w przypadku ogrzewania podłogowego. Fugi pozwalają też zniwelować różnice wymiarowe płytek. Szerokość fugi zależy przede wszystkim od wymiarów płytki, należy pamiętać o tym, żeby dobrać właściwy rodzaj spoiny do określonej szerokości. Miejsca wilgotne, na ogrzewaniu podłogowym lub w temperaturach ujemnych wymagają innego rodzaju fugi.

JOINTS

Joint is an aesthetic supplement of the ceramic or stone floor. It is also a specific expansion joint between the tiles, which allows them to deform minimally, particularly when the activity of the bed leads to stresses, e.g. in the case of floor heating. Joints enable us to level the tiles' size differences. The width of the joint especially depends on the size of the tile; it should be remembered to match the right size of the joint to the specific width. Damp places, on floor heating or in temperatures below zero require a different type of joints.

TRANSPORT

Podczas transportu należy jednostki ładunkowe ustawiać ściśle obok siebie. Wolne przestrzenie należy zabezpieczyć, uniemożliwiając przesuwanie się ładunku podczas transportu.

TRANSPORTATION

While transporting tiles, unit loads should be arranged tightly side by side. Free spaces should be secured to prevent from shifting the load during transportation.

PRZECHOWYWANIE

Płytki należy przechowywać w pomieszczeniach chroniących je przed zawilgoceniem, a w przypadku płytek niemrozoodpornych należy je chronić również przed temperaturą mniejszą lub równą 0°C. Nie uważa się za wady produkcyjne defektów spowodowanych przechowywaniem płytek niemrozoodpornych w temperaturze poniżej 0°C, bądź zmian w płytkach spowodowanych ich niewłaściwym przechowywaniem przed dokonaniem montażu.

STORAGE

Tiles should be stored in rooms, which protect them from moisture, and non frost-proof tiles should be also protected from temperatures lower or equal to 0°C. Defects caused by the storage of non frost-proof tiles in the temperature above 0°C, or changes in tiles caused by their improper storage prior to the installation are not considered as manufacturing defects.



LEGENDA KEY



plytka mrozoodporna
frost-resistant tile



klasa antypoślizgowości
non-slip class



przeciwoślizgowość – zatrzymywanie cieczy
slip resistance – liquid retention



przeciwoślizgowość – bosa stopa
slip resistance – bare foot



klasa ścieralności
abrasion-resistance class

Certyfikaty i znaki jakości do pobrania ze strony internetowej www.rovesepro.com

Certificates and quality marks available for download from the website www.rovesepro.com

Katalog jest materiałem poglądowym. Producent zastrzega sobie prawo zmian w ofercie przedstawionej w katalogu.

Ze względu na stosowaną technikę druku rzeczywisty wygląd płytek może różnić się od produktów prezentowanych na zdjęciach.

This material is for demonstration purposes only. The manufacturer reserves the right to change the offer presented herein.

Due to the printing techniques used, the real appearance of tiles may be slightly different from the products as shown in the pictures.

ROVESE S.A.

Al. Solidarności 36
25-323 Kielce
KONTAKT DO DZIAŁU INWESTYCJI
CONTACT: INVESTMENT DEPARTMENT

www.rovesepro.com



Wyposażenie łazienek dla niepełnosprawnych
Bathroom fixtures for the disabled

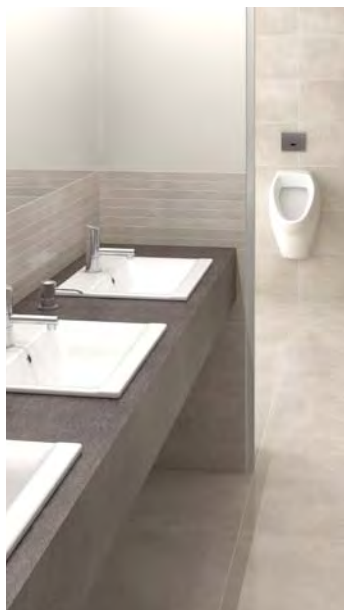

Umywalki
Washbasins

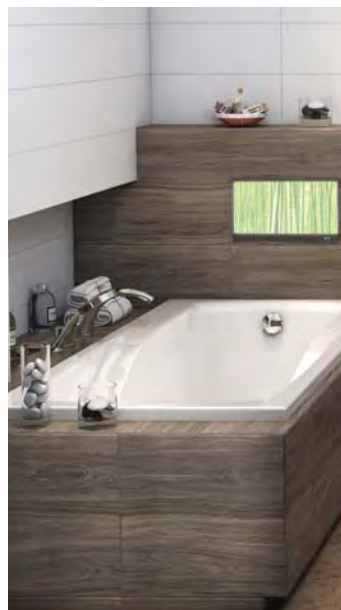

Wanny
Bathtubs



Kabiny, brodziki
Shower enclosures and trays

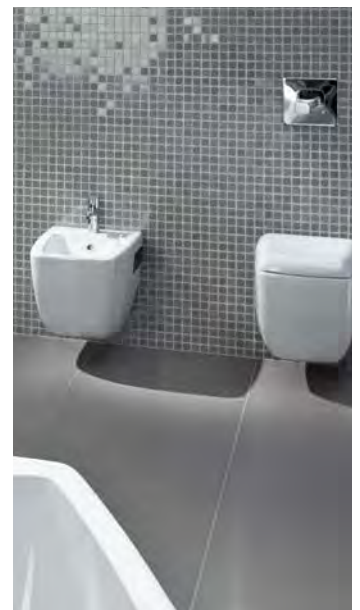

Miski zawieszane, bidety
Wall hung bowls, bidets