



MASTERLINE
by Bisk

CATALOGUE / KATALOG

2015

TABLE OF CONTENTS SPIS TREŚCI

- 04/ Paper dispensers
Podajniki na papier
- 05/ Automatic dryers
Suszarki automatyczne
- 06/ Soap dispensers
Dozowniki mydła
- 09/ Waste baskets
Kosze na śmieci
- 10/ Exploataion materials
Materiały eksploatacyjne
- 11/ Supplementary accessories
Akcesoria uzupełniające
- 13/ PRO accessories
Akcesoria z serii PRO
- 16/ Selected BISK bathroom accessories
Wybór akcesoriów łazienkowych BISK

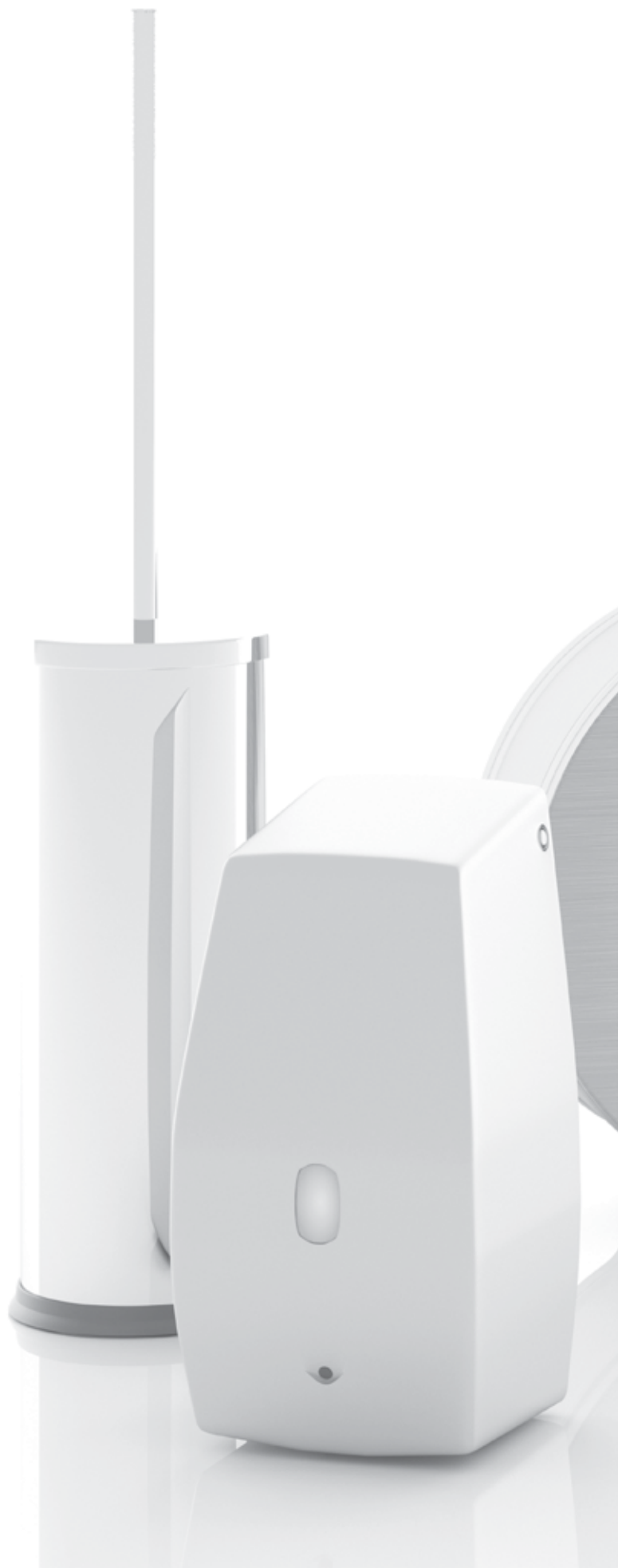

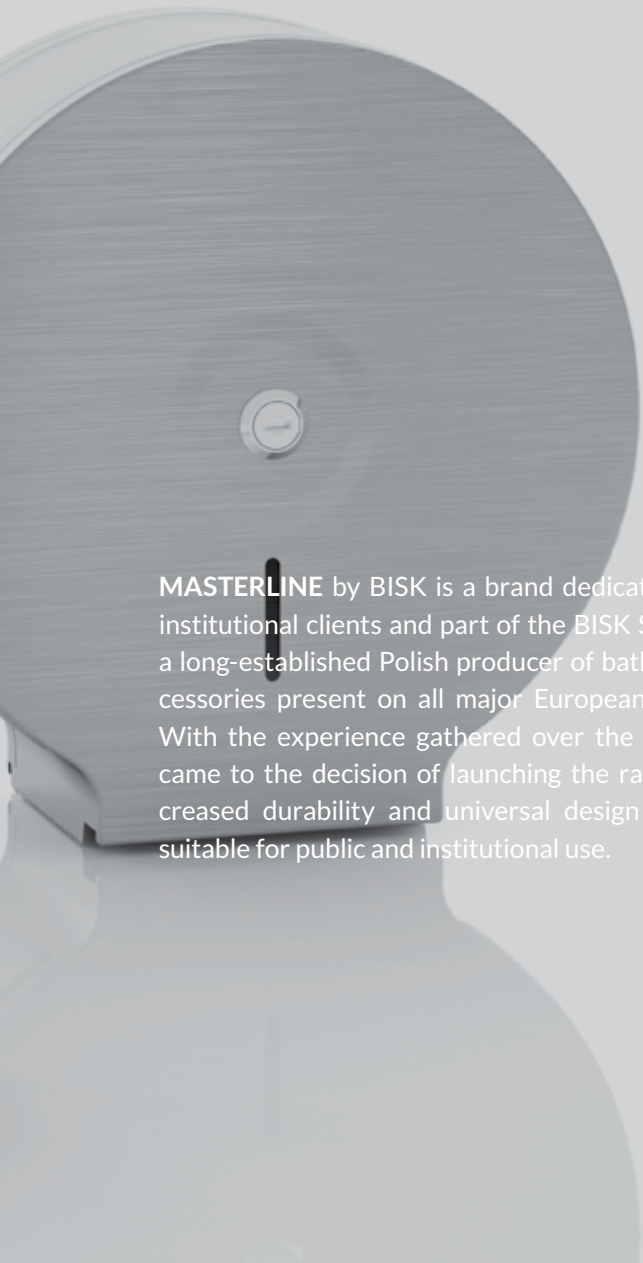

MASTERLINE by BISK is a brand dedicated to the institutional clients and part of the BISK SA Group, a long-established Polish producer of bathroom accessories present on all major European markets. With the experience gathered over the years, we came to the decision of launching the range of increased durability and universal design products suitable for public and institutional use.

MASTERLINE

by Bisk

MASTERLINE by BISK to marka dedykowana klientom instytucjonalnym, wchodząca w skład portfolio Grupy BISK S.A., polskiego producenta akcesoriów łazienkowych, działającego na wszystkich najważniejszych rynkach europejskich. Zgromadzone przez lata doświadczenie Grupy zaowocowało stworzeniem gamy produktów, które poprzez rygorystyczną kontrolę jakości oraz uniwersalne wzornictwo doskonale wpisują się w charakter przestrzeni publicznej.



03863

PRP-1
PP
white/biały
A 165 B 270 C 150
paper rolls Ø14 cm
rolki papieru Ø14 cm
paper towels
250 pcs, 25x23 cm
papier w listkach
250 szt., 25x23 cm



00398

PL-P2
ABS
silver matt/srebrny mat
A 263 B 294 C 148
paper towels
500 pcs, 25x23 cm
papier w listkach
500 szt., 25x23 cm



00505

Jumbo-P2
ABS
silver matt/srebrny mat
A 267 B 258 C 117
for toilet rolls max Ø 23 cm
rolki papieru max Ø 23 cm



01570

Jumbo-S2
stainless steel/stal nierdzewna
chrome/chrom
A 262 B 254 C 120
for toilet rolls max Ø 23 cm
rolki papieru max Ø 23 cm



01571

PL-S2
stainless steel/stal nierdzewna
chrome/chrom
A 266 B 284 C 100
paper towels
500 pcs, 25x23 cm
papier w listkach
500 szt., 25x23 cm

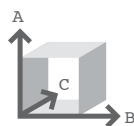

MASTERLINE CATALOGUE 2015 / KATALOG MASTERLINE 2015

MASTERLINE CATALOGUE 2015 / KATALOG MASTERLINE 2015



04305

PU-P1
ABS
white/biały
A 290 B 150 C 140
for toilet rolls 2x Ø12 cm
rolki papieru 2x Ø12cm
paper towels 11,5x12,5 cm
papier w listkach 11,5x12,5 cm



00344

PL-P1
ABS
white/biały
A 263 B 294 C 148
paper towels
500 pcs, 25x23 cm
papier w listkach
500 szt., 25x23 cm



00399

Jumbo-P1
ABS
white/biały
A 267 B 258 C 117
for toilet rolls max Ø 23 cm
rolki papieru max Ø 23 cm



00343

Jumbo-S1
stainless steel/stal nierdzewna
brushed/szczotkowana
A 262 B 254 C 120
for toilet rolls max Ø 23 cm
rolki papieru max Ø 23 cm



00342

PL-S1
stainless steel/stal nierdzewna
brushed/szczotkowana
A 266 B 284 C 100
paper towels
500 pcs, 25x23 cm
papier w listkach
500 szt., 25x23 cm

AUTOMATIC DRYERS / SUSZARKI AUTOMATYCZNE

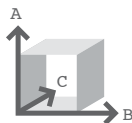

MASTERLINE CATALOGUE 2015 / KATALOG MASTERLINE 2015

MASTERLINE CATALOGUE 2015 / KATALOG MASTERLINE 2015



01801
SRM-S1
stainless steel/stal nierdzewna
brushed/szczotkowana
A 235 B 260 C 145
2300W, 78dB
CE



01574
SR-P2
ABS
silver matt/srebrny mat
A 300 B 240 C 145
1200W, 63dB
CE



01569
SR-S2
stainless steel/stal nierdzewna
chrome/chrom
A 280 B 220 C 150
1650W, 63dB
CE



00194
SR-P1
ABS
white/biała
A 300 B 240 C 145
1200W, 63dB
CE



00195
SR-S1
stainless steel/stal nierdzewna
brushed/szczotkowana
A 280 B 220 C 150
1650W, 63dB
CE



00241
SU-P1
ABS
white/biały
A 255 B 180 C 145
800W, 67dB
CE



01802
SH-P1
ABS
white/biały
A 220 B 90 C 145
1200W, 75dB
CE

SOAP / DOZOWNIKI DISPENSERS / MYDŁA



 also for disinfection gel & liquid
także do: żel i płyn dezynfekujący

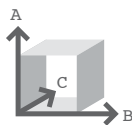

**NEW
2015**



05880
D2
stainless steel/stal nierdzewna
chrome/chrom
A 295 B 97 C 105
1000 ml



04957
D1
stainless steel/stal nierdzewna
brushed/szczotkowana
A 295 B 97 C 105
1000 ml



04959
DP1
stainless steel/stal nierdzewna
brushed/szczotkowana
A 295 B 97 C 105
1000 ml

MASTERLINE CATALOGUE 2015 / KATALOG MASTERLINE 2015



01415
stainless steel/stal nierdzewna
chrome/chrom
A 153 B 98 C 98
500 ml



04084
stainless steel/stal nierdzewna
brushed/szczotkowana
A 150 B 103 C 105
500 ml



01416
stainless steel/stal nierdzewna
chrome/chrom
A 202 B 125 C 107
1000 ml



01417
stainless steel/stal nierdzewna
brushed/szczotkowana
A 202 B 125 C 107
1000 ml

MASTERLINE CATALOGUE 2015 / KATALOG MASTERLINE 2015



72027
ABS
white/biały
A 195 B 80 C 80
350 ml



72067
ABS
silver matt/srebrny mat
A 195 B 80 C 80
350 ml



72075
ABS
chrome/chrom
A 195 B 80 C 80
350 ml



02923
P1/ABS
white/biały
03133
P2/ABS
silver matt/srebrny mat
A 210 B 98 C 115
750 ml

SOAP DISPENSERS / DOZOWNIKI MYDŁA



also for disinfection gel & liquid
także do: żel i płyn dezynfekujący



no-touch system
bezdotykowy

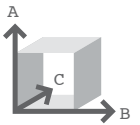

NEW 2015



▶ automatic



05903

AK1 / ABS
white/biały
A 217 B 110 C 100
500 ml

NEW 2015



▶ automatic



05904

AK2 / ABS
silver matt/srebrny mat
A 217 B 110 C 100
500 ml

NEW 2015



▶ automatic



05905

AK3 / ABS
chrome/chrom
A 217 B 110 C 100
500 ml



03558

ABS
white/biały
A 210 B 97 C 104
500 ml

▶ automatic



00588

ABS
white/biały
A 217 B 110 C 100
500 ml

▶ automatic



00589

ABS
silver matt/srebrny mat
A 217 B 110 C 100
500 ml



02280

ABS
L1: white/biały

02281

ABS
L2: silver matt/srebrny mat
A 275 B 110 C 105
1000 ml



02275

K1/ABS
white/biały

02276

K2/ABS
silver matt/srebrny mat
A 208 B 90 C 100
500 ml



00174

ABS
white/biały
A 250 B 138 C 80
2x400 ml



00175

ABS
chrome/chrom
A 250 B 138 C 80
2x400 ml



00173

ABS
chrome/chrom
A 250 B 84 C 80
400 ml



00172

ABS
white/biały
A 250 B 84 C 80
400 ml

MASTERLINE CATALOGUE 2015 / KATALOG MASTERLINE 2015

MASTERLINE CATALOGUE 2015 / KATALOG MASTERLINE 2015

SOAP DISPENSERS / DOZOWNIKI MYDŁA

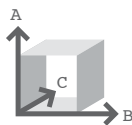

07402
A1 / ABS
white/biały
A 157 B 98 C 85
500 ml



07517
A2 / ABS
silver matt/srebrny mat
A 157 B 98 C 85
500 ml



07600
A3 / ABS
chrome/chrom
A 157 B 98 C 85
500 ml



07802
C / ABS
white/biały
A 190 B 113 C 110
1000 ml

MASTERLINE CATALOGUE 2015 / KATALOG MASTERLINE 2015



solid brass/mosiądz
04760
BL1: brushed nickel/nikiel szczotkowany
04759
BL2: chrome/chrom
A 448 B 180 C 90
1000 ml

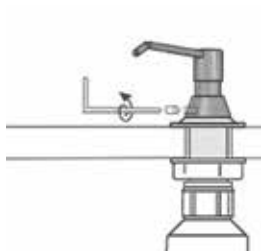

07702
B / ABS
white/biały
A 280 B 81 C 113
1000 ml



MASTERLINE
by Bisk

seria PRO

Safe home



Bezpieczny dom



installation
montaż

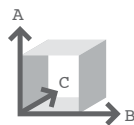

STAINLESS STEEL
STAL NIERDZEWNA
CHROME/CHROM

- 00057 / 3l
A 265 B 165 C 225
- 00283 / 5l
A 280 B 205 C 260
- 00056 / 7l
A 315 B 205 C 260
- 00430 / 12l
A 395 B 320 C 250
- 00060 / 20l
A 445 B 365 C 305



STAINLESS STEEL
STAL NIERDZEWNA
BRUSHED/SZCZOTKOWANA

- 00125 / 3l
A 265 B 165 C 225
- 03275 / 5l
A 280 B 105 C 260
- 00431 / 12l
A 395 B 320 C 250
- 01017 / 20l
A 445 B 365 C 305



STAINLESS STEEL
STAL NIERDZEWNA

- 00122 / 6l
chrome/chrom
A 295 B 205 C 250

04045 >



STAINLESS STEEL
STAL NIERDZEWNA

00390 >

- 00390 / 35l
brushed/szczotkowana
A 490 B 420 C 190
- 04045
lid/pokrywa kosza

▲ wall mounted/mocowany do ściany

POLIPROPYLENE/POLIPROPYLEN



- 91927 / 10l
white/biały
A 410 B 240 C 240



- 93002 / 15l
white/biały
A 500 B 275 C 275

POLIPROPYLENE/POLIPROPYLEN



- 93902 / 8l
white/biały
A 370 B 250 C 230



- 90302 / 5l
white/biały
A 300 B 200 C 200

MASTERLINE CATALOGUE 2015 / KATALOG MASTERLINE 2015

BISK CATALOGUE
KATALOG BISK

2015



EXPLOITATION/MATERIAŁY

MATERIALS EKSPLOATACYJNE



02796 / 1l
liquid soap/mydło w płynie



02795 / 5l
liquid soap/mydło w płynie



03158 / 5l
soft foam soap/mydło w pianie



05890
ZZ
size/rozmiar: 25x23 cm



03354
MINI - Ø 14 cm
length/długość - 65 m



03353
MINI - Ø 14 cm
length/długość - 60 m



03355
JUMBO - Ø 18,5 cm
length/długość - 120 m

MASTERLINE CATALOGUE 2015 / KATALOG MASTERLINE 2015

DECORATION ACCESSORIES

AKCESORIA DEKORACYJNE



NICE SEA



STAINLESS STEEL / STAL NIERDZEWNA

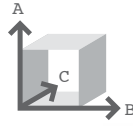

01419
brushed/szczotkowana
A 60 B 130 C 10



01418
chrome/chrom
A 60 B 130 C 10



71275
chrome/chrom
A 55 B 265 C 70
Ø 19 mm



71850
chrome/chrom
A 55 B 335 C 80
Ø 22 mm

71276
brushed/szczotkowana
A 55 B 265 C 70
Ø 19 mm



71926
brushed/szczotkowana
A 200 B 440 C 115
Ø 25 mm



71925
chrome/chrom
A 200 B 440 C 115
Ø 25 mm



00102
chrome/chrom
A 55 B 640 C 80
Ø 25 mm

STEEL / STAL



00042
chrome/chrom
A 180 B 625 C 275



00048
chrome/chrom
A 335 B 235 C 170



00045
chrome/chrom
A 30 B 235 C 170

00044
chrome/chrom
A 30 B 195 C 120



71851
brushed/szczotkowana
A 55 B 335 C 80
Ø 22 mm



00046
chrome/chrom
A 30 B 135 C 90

00047
chrome/chrom
A 30 B 205 C 95



71876
brushed/szczotkowana
A 240 B 380 C 80
Ø 25 mm



71875
chrome/chrom
A 240 B 380 C 80
Ø 25 mm



02542
brushed nickel/szczotkowany nikiel
A 140 B 550 C 232



02543
chrome/chrom
A 140 B 550 C 232

MASTERLINE CATALOGUE 2015 / KATALOG MASTERLINE 2015

MASTERLINE CATALOGUE 2015 / KATALOG MASTERLINE 2015

SUPPLEMENTARY ACCESSORIES / AKCESORIA

UZUPEŁNIAJĄCE



00176
stainless steel/stal nierdzewna
chrome/chrom
A 265 B 100 C 100



00234
stainless steel/stal nierdzewna
brushed/szczotkowana
A 265 B 100 C 100

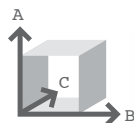

01016
stainless steel/stal nierdzewna
brushed/szczotkowana
A 267 B 95 C 110

▲ wall mounted/mocowana do ściany



71429
stainless steel/stal nierdzewna
chrome/chrom
A 267 B 95 C 110

▲ wall mounted/mocowana do ściany



00119
stainless steel/stal nierdzewna
chrome/chrom
A 270 B 110 C 110



00121
stainless steel/stal nierdzewna
brushed/szczotkowana
A 270 B 110 C 110

MASTERLINE CATALOGUE 2015 / KATALOG MASTERLINE 2015



02722
PP
white/biały
A 400 B 120 C 120



93702
PP
white/biały
A 370 B 125 C 125



80502
PP
white/biały
A 400 B 160 C 160



72402
aluminium
white/biały
125x220cm, Ø 22mm

72202
aluminium
white/biały
70x120cm, Ø 22mm

00037
stainless steel/stal nierdzewna
chrome/chrom
125x220cm, Ø 22mm

00080
stainless steel/stal nierdzewna
chrome/chrom
70x120cm, Ø 22mm

MASTERLINE CATALOGUE 2015 / KATALOG MASTERLINE 2015



08702
TXT
white/biały
180x200cm



03502
PEVA
white/biały
180x200cm



aluminium
00081
chrome/chrom
90x90x90cm, Ø 20mm



aluminium
72502
white/biały
90x90x90cm, Ø 20mm



set of 12pcs/kpl. 12szt.
91202
plastic/plastik
white/biały
97200
plastic/plastik
transparent/przezroczysty

PROseria ACCESSORIES / AKCESORIA

technical drawings - p. 21 / rysunki techniczne - str. 21

5 YEARS GUARANTEE
LAT GWARANCJI

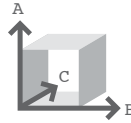

stainless steel/stal nierdzewna
Ø 25 mm

max 150 kg
test 180 kg



MASTERLINE CATALOGUE 2015 / KATALOG MASTERLINE 2015

stainless steel/stal nierdzewna
Ø 25 mm

max 150 kg
test 180 kg

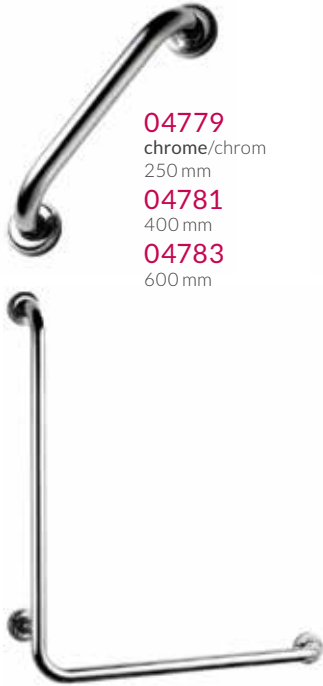

04779
chrome/chrom
250 mm
04781
400 mm
04783
600 mm

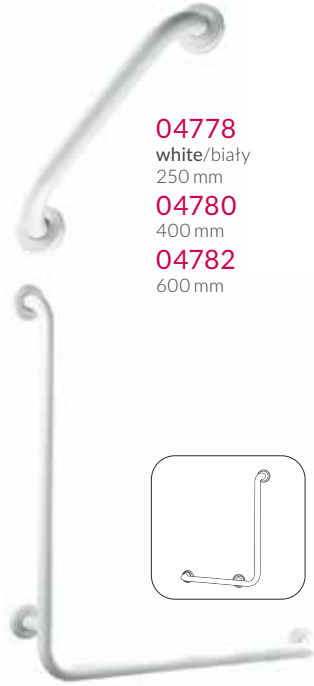

04778
white/biały
250 mm
04780
400 mm
04782
600 mm

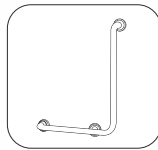

05499
chrome/chrom
600 mm



05498
white/biały
600 mm

MASTERLINE CATALOGUE 2015 / KATALOG MASTERLINE 2015

stainless steel/stal nierdzewna
Ø 25 mm

max 120 kg
test 180 kg



04777
chrome/chrom
220x220 mm



04776
white/biały
220x220 mm



04787
chrome/chrom
700 mm



04786
white/biały
700 mm

max 150 kg
test 180 kg



04788
AI/ABS
A 103 B 320 C 328



installation
montaż

Atest PZH



Carry the CE mark, have hygienic approval from the National Institute of Hygiene of the Polish Institute of Public Health, are registered with The Office for Registration of Medicinal Products, Medical Devices and Biocidal Products as Class I medical devices.

Wyroby zarejestrowane w Urzędzie Rejestracji Produktów Leczniczych, Wyrobów Medycznych i Produktów Biobójczych jako Wyrób Medyczny Klasy I.

ACCESSORIES / AKCESORIA **PRO** *seria*

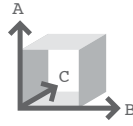

04848
 Al/PE
 A 220 B 730 C 180

max 150 kg
 test 180 kg



max 576 mm
 min 348 mm

04813
 Al/PE
 A 348-576 B 325 C 325

max 150 kg
 test 180 kg



04965
 A 255 B 260 C 50

max 130 kg



680 mm

stainless steel/stal nierdzewna
 chrome/chrom
04956
 A 680 B 103 C 103

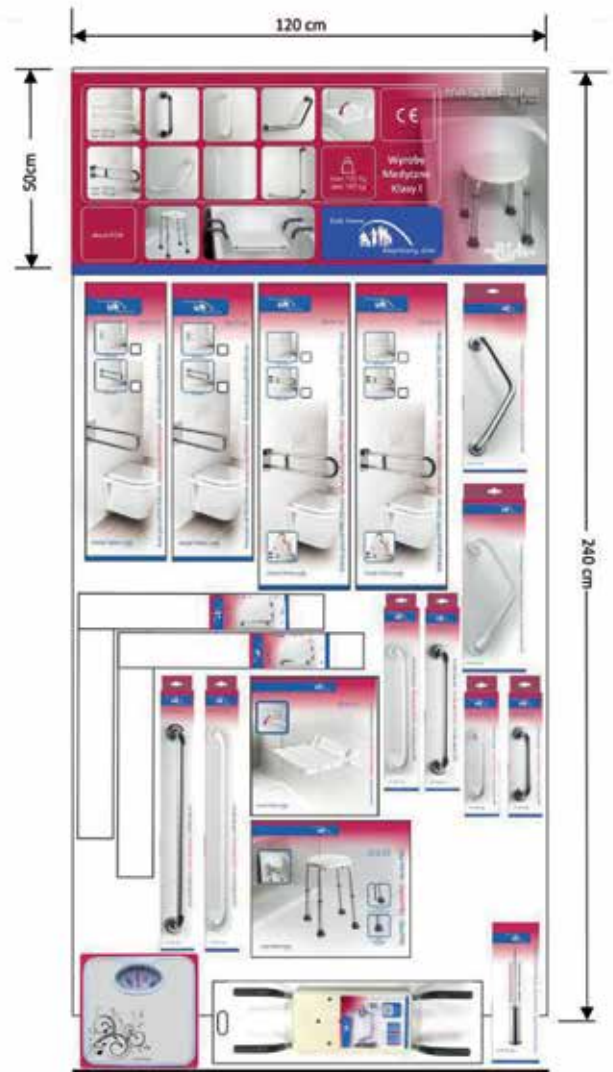

MASTERLINE CATALOGUE 2015 / KATALOG MASTERLINE 2015

MASTERLINE CATALOGUE 2015 / KATALOG MASTERLINE 2015

HANDICAP / AKCESORIA

ACCESSORIES / DLA NIEPEŁNOSPRAWNYCH



stainless steel/stal nierdzewna
00163
chrome/chrom, Ø30 mm
60 cm, Ø30 mm



painted steel/stal malowana
01398
white/biały, 60 cm, Ø25 mm
01399
white/biały, 70 cm, Ø25 mm



stainless steel/stal nierdzewna
chrome/chrom, Ø30 mm
00167
75 x 80 cm, right/prawy
01384
75 x 80 cm, left/lewy



painted steel/stal malowana
white/biały, Ø25 mm
01400
75 x 60 cm, right/prawy
01524
75 x 60 cm, left/lewy
01525
75 x 70 cm, right/prawy
01526
75 x 70 cm, left/lewy



stainless steel/stal nierdzewna
chrome/chrom, Ø30 mm
00165
55 cm, right/prawy
00166
55 cm, left/lewy



painted steel/stal malowana
white/biały, Ø25 mm
01390
50 cm, right/prawy
01391
50 cm, left/lewy



stainless steel/stal nierdzewna
chrome/chrom
01385
60 x 60 cm



stainless steel/stal nierdzewna
01386
45 x 40 cm
chrome/chrom, Ø25 mm
01527
45 x 40 cm
white/biały, Ø25 mm
painted steel/stal malowana

MASTERLINE CATALOGUE 2015 / KATALOG MASTERLINE 2015

MASTERLINE CATALOGUE 2015 / KATALOG MASTERLINE 2015

SELECTED WYBRANE
COLLECTIONS/KOLEKCJE

BLACKLABEL
Futura

5 YEARS GUARANTEE
LAT GWARANCJI

BLACK SATIN / CZARNA SATYNA



02963



02962



02959



02953



02969



02961



02954



02960



02957



02968



02966 (460)



02967 (610)

MASTERLINE CATALOGUE 2015 / KATALOG MASTERLINE 2015

MASTERLINE CATALOGUE 2015 / KATALOG MASTERLINE 2015



02965



02952



02956



02958

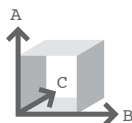

01173
A 45 B 70 C 60



02943
A 60 B 110 C 65



02924
A 70 B 110 C 130



03038
A 100 B 155 C 65



01178
A 165 B 160 C 65



04751
A 64 B 470 C 38



01180
A 45 B 640 C 65



01181
A 45 B 610 C 115



01183
A 45 B 525 C 155



01177
A 175 B 125 C 90



01174
A 95 B 125 C 85



01175
A 95 B 190 C 85



01176
A 45 B 155 C 90



01179
A 125 B 160 C 65



01182
A 375 B 165 C 125

MASTERLINE CATALOGUE 2015 / KATALOG MASTERLINE 2015

MASTERLINE CATALOGUE 2015 / KATALOG MASTERLINE 2015



ARKTIC

CHROME / CHROM

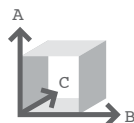

VIRGINIA

BRUSHED NICKEL / SZCZOTKOWANY NIKIEL



01465
A 95 B 68 C 128



01467
A 70 B 135 C 130



72080
A 90 B 66 C 110



72077
A 60 B 70 C 50



01476
A 155 B 65 C 120



01464
A 50 B 200 C 30



72082
A 60 B 135 C 125



72089
A 155 B 65 C 115



01461
A 50 B 500 C 128



72142*
A 50 B 210 C 30



72079
A 130 B 140 C 55



01469
A 50 B 510 C 75



01463
A 50 B 85 C 50



72076
A 60 B 605 C 155



01473
A 145 B 125 C 40



00131
BISK FEST glue
klej BISK FEST



01475
A 385 B 115 C 165

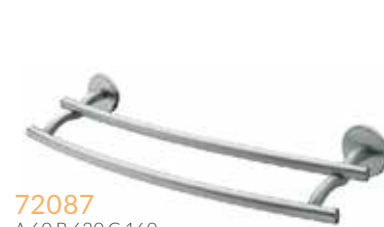

72087
A 60 B 620 C 160



72092
A 60 B 70 C 165



72088
A 375 B 115 C 155

MASTERLINE CATALOGUE 2015 / KATALOG MASTERLINE 2015

MASTERLINE CATALOGUE 2015 / KATALOG MASTERLINE 2015

ARKTIC

DEDICATED FAUCET COLLECTION
DEDYKOWANA KOLEKCJA ARMATURY

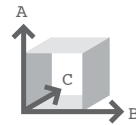

VIRGINIA

DEDICATED FAUCET COLLECTION
DEDYKOWANA KOLEKCJA ARMATURY



MASTERLINE CATALOGUE 2015 / KATALOG MASTERLINE 2015

MASTERLINE CATALOGUE 2015 / KATALOG MASTERLINE 2015

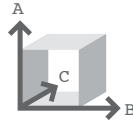

46842
A 60 B 45 C 40



41142
A 78 B 325 C 70



47142
A 90 B 235 C 75



40842
A 35 B 120 C 35



47042
A 85 B 585 C 90



41042
A 50 B 580 C 140



40242
A 60 B 585 C 140



40742
A 100 B 120 C 120



47242
A 100 B 185 C 105



40542
A 40 B 160 C 110



40442
A 130 B 160 C 70

440x440x40mm



51302
A 40 B 440 C 440

MASTERLINE CATALOGUE 2015 / KATALOG MASTERLINE 2015

MASTERLINE CATALOGUE 2015 / KATALOG MASTERLINE 2015

PRO *seria* ACCESSORIES / AKCESORIA

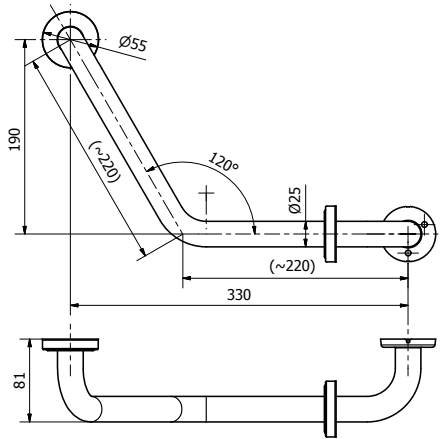

04777
04776

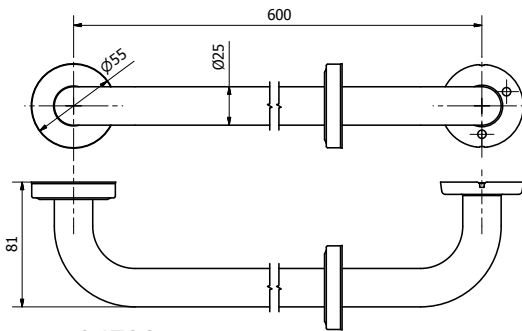

04783
04782

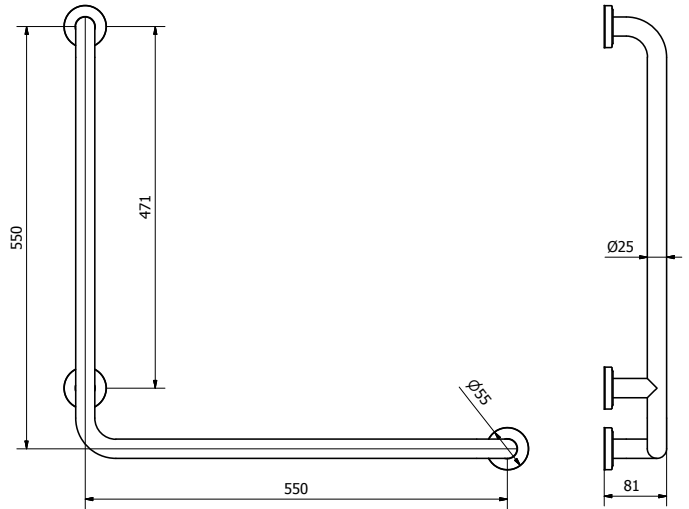

04785
04784

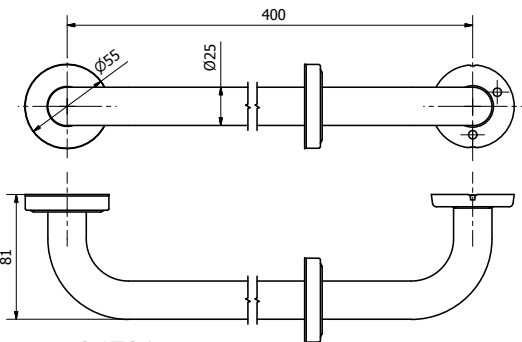

04781
04780

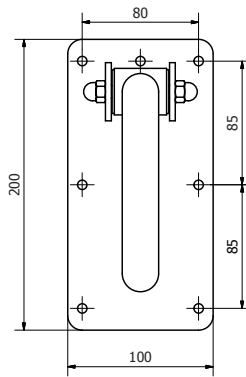

04787
04786

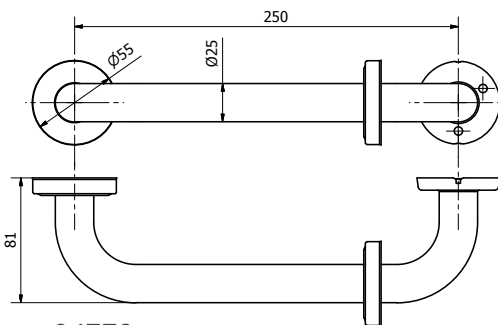
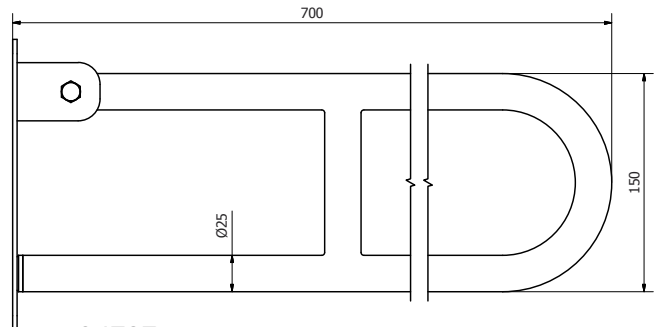

04779
04778

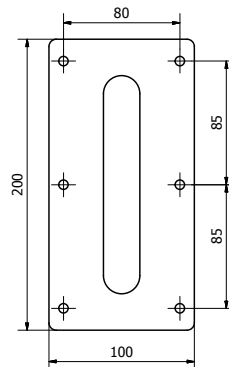

05498
05499

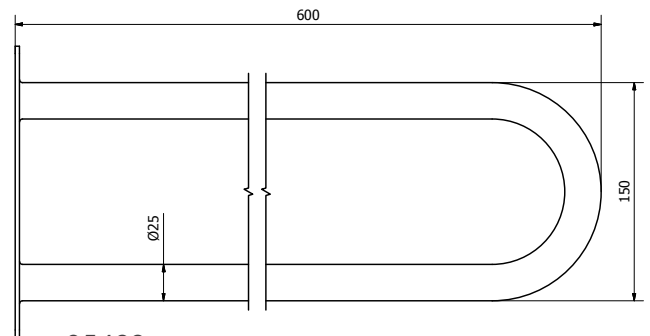





Safe home



Bezpieczny dom



BISK S.A. | ul. Podleśna 19, Łubna, 05-532 Baniocha, Poland
tel. +48 22 736 46 01, fax +48 22 750 36 20, e-mail: bisk@bisk.eu, www.bisk.eu