







GENERAL
CATALOGUE
2017 - 2018







DESIGN LOVERS





INDICATIONS FOR USE | INDICACIONES DE USO

-  Floor tiles
Pavimento
Sol
Bodenfliese
-  Wall tiles
Revestimiento
Faïence
Wandfliese
-  Do not bond
No trabar
Ne pas mettre en quinconces
Kein verbandrerlegung
-  Do not bond +20%
No trabar +20%
Ne pas mettre en quinconces a +de 20%
Max 1/5 verbandrerlegung
-  Rectified edges
Canto rectificado
Bords rectifiés
Halbriert
-  Suitable for cutting
Se puede cortar
Il est possible coupé
Geschnitten zu werden ist möglich
-  Gathered
Rejuntar
Rejointe
Verfugen
-  Meshed
Enmallado
Mosaïque su filet
Mosaik auf netz









SURFACE LOOK | ASPECTO SUPERFICIAL

-  Gloss
Brillo
Brillant
Glänzend
-  Matt
Mate
Mat
Matt
-  Semi-polished
Semi-pulido
Semi-poli
Anpoliert
-  Soft
-  Honed
-  Patterns
Caras
Tampons
Grafiken







SHADE VARIATION | DESTONIFICACIÓN

-  V2 Low shade variation
Producto destonificado
Produit dénuancé
Produkt mit farbabweichungen
-  V3 Medium shade variation
Destonificación sustancial
Légèrement dénuancé
Produkt mit hohen farbabweichungen
-  V4 High shade variation
Producto muy destonificado
Produit très dénuancé
Produkt mit sehr hohen farbabweichungen

TECHNICAL DATA | DATOS TÉCNICOS

-  Absorption
Absorción
Absorption
Wasseraufnahme
-  Frost resistance
Antihielo
Résistance au gel
Frostsicher
-  Mohs
-  Thickness ±5%
Espesor ±5%
Épaisseur ±5%
Stärke ±5%
-  Resistance to staining
Resistencia a las manchas
Résistance aux taches
Beständigkeit gegen fleckenbildung
-  GA | UA
Resistance to cleaning agents
Resistencia agentes de limpieza
Résistance aux produits d'entretien
Beständigkeit gegen reinigungsmittel
-  GHA | ULA
Resistance to high acid concentration
Resistencia a los ácidos en altas concentraciones
Résistance aux acides de forte concentration
Säurebeständigkeit bei hohen konzentrationen
-  GLA | GLA
Resistance to low acid concentration
Resistencia a los ácidos en bajas concentraciones
Résistance aux acides de faible concentration
Säurebeständigkeit bei schwachen konzentrationen

USE | USO

-  Wall tiles
Revestimiento
Faïence
Wandfliese
-  Surfaces with moderate traffic. Bedrooms and bathrooms in the home
Superficies sometidas a tráfico moderado. Dormitorios y baños de las viviendas
Passage léger: salles de bains et chambre
Schwache beanspruchung. Private bäder und schlafzimmer
-  Surfaces with medium traffic. All the house, kitchen, terrace, etc
Superficies sometidas a tráfico medio. Toda la vivienda, cocinas, terrazas, etc
Passage moyen: immeubles, éléments communs, cuisines, bureaux et maison individuelle
Mittlere beanspruchung. Wohnbereiche, küchen, büros, familienhäuser
-  Surfaces with intense traffic. Public places, shops, restaurants, offices, etc
Superficies sometidas a tráfico intenso. Lugares públicos, tiendas, restaurantes, oficinas, etc
Passage intensif: magasins, hall, locaux publics et centres commerciaux
Hohe beanspruchung. Geschäfte, öffentliche gebäude und einkaufszentren
-  UPEC
-  ANTISLIP
-  ANTISLIP SHOELESS TECHNOLOGY

Keraben



INDEX OF CONTENTS

ÍNDICE DE CONTENIDOS | TABLE DES MATIÈRES | VERZEICHNIS

OUR VALUES NUESTROS VALORES	4
FINISHES ACABADOS	22
20MM THICKNESS 20MM ESPESORADO	24
COLLECTION INDEX ÍNDICE DE COLECCIONES	26
SIZES INDEX ÍNDICE POR FORMATOS	28
STYLE INDEX ÍNDICE DE ESTILOS	30
APPLICATION INDEX ÍNDICE DE USO TÉCNICO	32
PRODUCT INDEX ÍNDICE DE ARTÍCULOS	34
COLLECTIONS COLECCIONES	48
TECHNICAL INFORMATION INDEX ÍNDICE DE INFORMACIÓN TÉCNICA	338
TECHNICAL INFORMATION INFORMACIÓN TÉCNICA	340

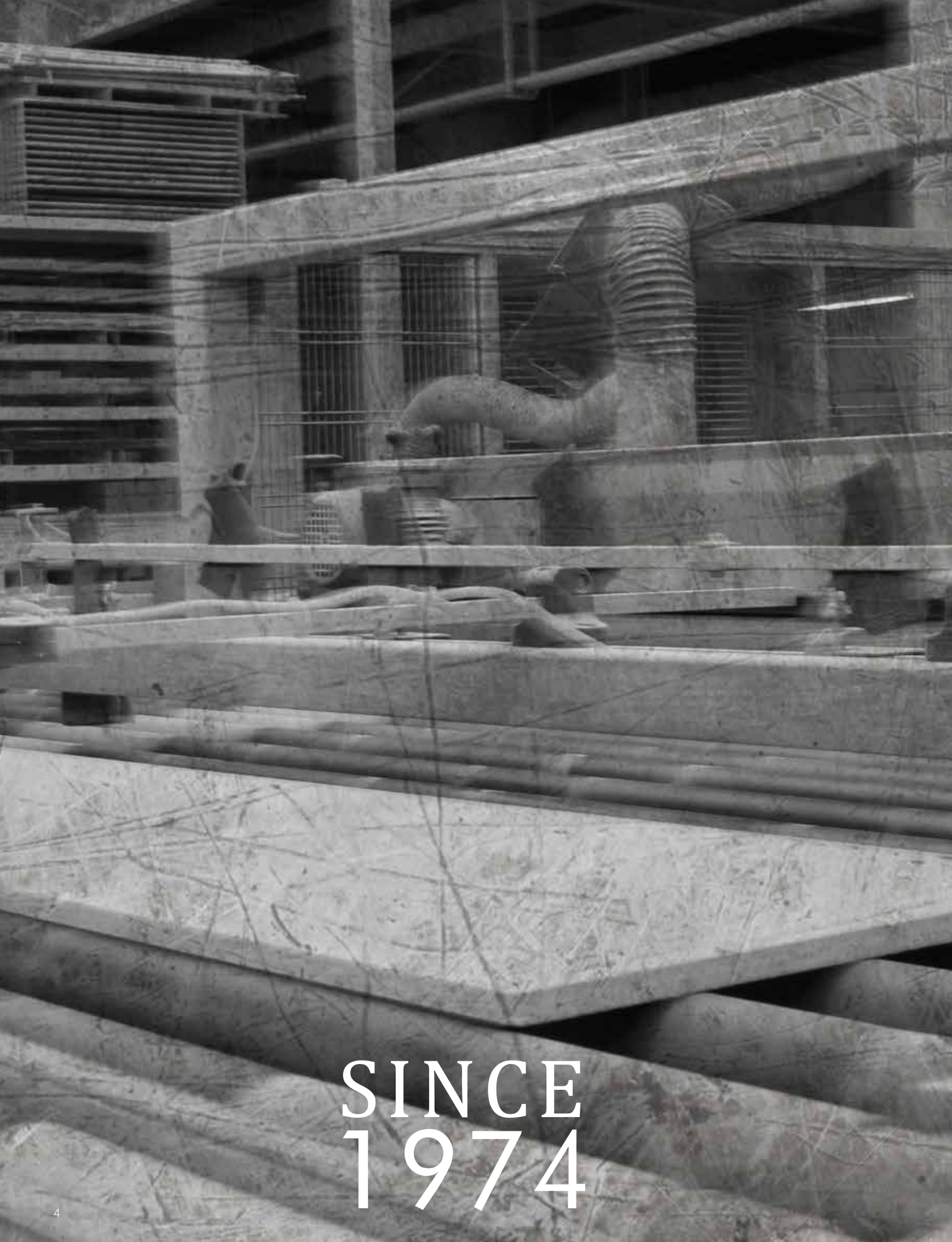

SINCE
1974

EXPERIENCE

SOMOS EXPERIENCIA | NOUS SOMMES SYNONYME D'EXPERIENCE | WIR STEHEN FÜR ERFAHRUNG

Keraben commenced its business activity in 1974 under the name Gres de Nules. Since then, customer service and ongoing technological innovation have formed the basis of our strategy.

Keraben inició su actividad en 1974 bajo la denominación Gres de Nules. Desde entonces, la orientación al cliente y la innovación tecnológica continua han guiado nuestros pasos.

Keraben a commencé son activité en 1974 sous la dénomination Gres de Nules. Depuis lors, nos pas n'ont cessé d'être guidés par l'innovation technologique et par une approche axée sur le client.

Die Firma Keraben wurde 1974 unter dem Namen Gres de Nules gegründet. Von Anfang an waren Kundenorientierung und technologische Innovation unser ständiges Bestreben.



DESIGN

SOMOS DISEÑO | NOUS SOMMES SYNONYME DE DESIGN | WIR STEHEN FÜR DESIGN

We design and develop our products from the drawing board to production, thereby guaranteeing unique textures and patterns for each piece.

Diseñamos y desarrollamos nuestros productos desde la concepción de la primera idea hasta la fabricación, de modo que cada pieza adquieren una gráfica y una textura única.

Nous prenons en charge le design et le développement de nos produits dès la conception de la première idée jusqu'à leur fabrication, afin que chaque pièce acquière un design et une texture uniques.

Wir entwerfen und entwickeln unsere Produkte selbst, d. h., der Prozess beginnt mit der ersten Idee und geht bis hin zur Herstellung, sodass jedes einzelne Teil ein einzigartiges Muster und seine eigene Textur erhält.



QUALITY

SOMOS CALIDAD | NOUS SOMMES SYNONYME DE QUALITÉ | WIR STEHEN FÜR QUALITÄT

The finest raw materials, cutting-edge ceramic tile technology and the commitment to excellence shown by our team of professionals are the finest guarantees for our consistently outstanding quality. Standards that are inextricably linked to our way of doing things.

Las mejores materias primas, la última tecnología cerámica y la vocación de excelencia de nuestros profesionales la hacen posible cada día. La calidad va íntimamente ligada a nuestra manera de hacer las cosas.

Elle est le fruit, jour après jour, des meilleures matières premières, de la toute dernière technologie céramique et de la perpétuelle quête d'excellence de la part de nos professionnels. La qualité est intimement liée à notre façon de faire les choses.

Beste Rohstoffe, modernste Keramiktechnologie und die Verpflichtung zur Vortrefflichkeit unserer fachlich erstklassigen Mitarbeiter ermöglichen es uns, Tag für Tag diese ausgezeichnete Qualität zu bieten, die in direktem Zusammenhang mit unserer Arbeitsweise steht.



S E R V I C E

SOMOS SERVICIO | NOUS SOMMES SYNONYME DE SERVICE | WIR STEHEN FÜR SERVICE

Designers, interior decorators, production, quality and environmental experts, the sales and logistic teams...more than 600 skilled professionals working for you.

Diseñadores, interioristas, técnicos de fabricación, calidad y medioambiente, equipo comercial y de logística... Más de 600 profesionales trabajando para ti.

Designers, décorateurs d'intérieurs, experts en fabrication, qualité et environnement, équipe commerciale et de logistique... Plus de 600 professionnels qui travaillent à votre service.

Designer, Innenausstatter, Fachleute in den Bereichen Produktion, Qualität und Umwelt, das Vertriebs- und das Logistikteam - insgesamt sind mehr als 600 professionelle Mitarbeiter für Sie im Einsatz.





SUSTAINABILITY

SOMOS SOSTENIBLES | NOUS SOMMES SYNONYME DE DURABILITÉ | WIR STEHEN FÜR NACHHALTIGKEIT

We reuse 100% of the water from our production processes, apply cogeneration to make the most of the energy we use, reintegrate the waste products from each process into our ceramic tiles, work with 100% recyclable packaging and have also certified all our procedures (ISO 14001, ISO 50001, ISO 14064, OSHAS, Global EPD), enabling you to put sustainability among the key reasons for choosing our ceramic tiles.

Reutilizamos el 100% del agua del proceso de fabricación, cogeneramos para aprovechar al máximo la energía consumida, reintegramos en la cerámica los residuos de cada proceso, trabajamos con packaging 100% reciclable y lo certificamos todo para que la sostenibilidad de nuestra cerámica sea un punto fuerte en tu elección.

Nous réutilisons 100% de l'eau employée dans le procédé de fabrication et ce, grâce au principe de la cogénération afin de tirer le plus grand profit de l'énergie consommée, nous réintégrons également dans la céramique les déchets de chaque procédé et nous travaillons avec un packaging 100% recyclable, tout étant certifié pour que la durabilité de notre céramique soit décisive lors de votre choix.

100 % des Wassers aus den Herstellungsprozessen werden wiederverwendet und mithilfe von Kraft-Wärmekopplung können wir die verbrauchte Energie maximal nutzen. Außerdem werden die Keramikabfälle aus jedem Herstellungsprozess recycelt, wir arbeiten mit 100 % recycelbaren Verpackungen und dies alles wird zertifiziert, damit die Nachhaltigkeit für Sie einen wichtigen Grund darstellt, sich für unsere Keramikprodukte zu entscheiden.





A GREAT COMPANY

SOMOS UNA GRAN EMPRESA | NOUS SOMMES UNE GRANDE SOCIÉTÉ | WIR STEHEN FÜR EIN GROSSES UNTERNEHMEN

With more than 600 professionals. With 2 production plants in Spain, where 100% of our products are manufactured. With an annual production capacity of more than 12,000,000 m². With an annual turnover of almost 120 million euros. 2% of our turnover is invested in R&D&I projects. 80% of our production is exported to more than 125 countries. We are one of Spain's leading exporters of ceramic tiles.

Contamos con más de 600 profesionales. Disponemos de 2 plantas de fabricación en España, donde producimos el 100% de nuestros productos. Tenemos una capacidad de producción que supera los 12.000.000 m² anuales. Facturamos cerca de 120 millones de euros al año. Invertimos el 2% de nuestra facturación en proyectos de I+D+i. Exportamos el 80% de nuestra producción a más de 125 países. Somos uno de los principales exportadores cerámicos del sector español.

Nous avons plus de 600 professionnels à notre actif. Nous possédons 2 usines de fabrication en Espagne, où nous produisons 100% de nos produits. Notre capacité de production dépasse les 12 000 000 m² par an. Notre chiffre d'affaires s'élève à près de 120 millions d'euros par an. Nous investissons 2% de notre chiffre d'affaires dans des projets de R+D+i. Nous exportons 80% de notre production vers plus de 125 pays. Nous sommes l'un des principaux exportateurs de céramique du secteur espagnol.

Wir verfügen über mehr als 600 fachkundige Mitarbeiter. Wir verfügen über 2 Fertigungsanlagen in Spanien, wo wir 100% unserer Produkte herstellen. Wir können jährlich bis zu 12.000.000 m² Keramikfliesen produzieren. Wir haben einen Jahresumsatz von 120 Millionen Euro. Wir investieren 2% unseres Umsatzes in Forschungs-, Entwicklungs- und Innovationsprojekte. Wir exportieren 80% unserer Produktion in über 125 Länder. Wir gehören zu den wichtigsten Exportunternehmen der spanischen Keramikfliesenbranche.

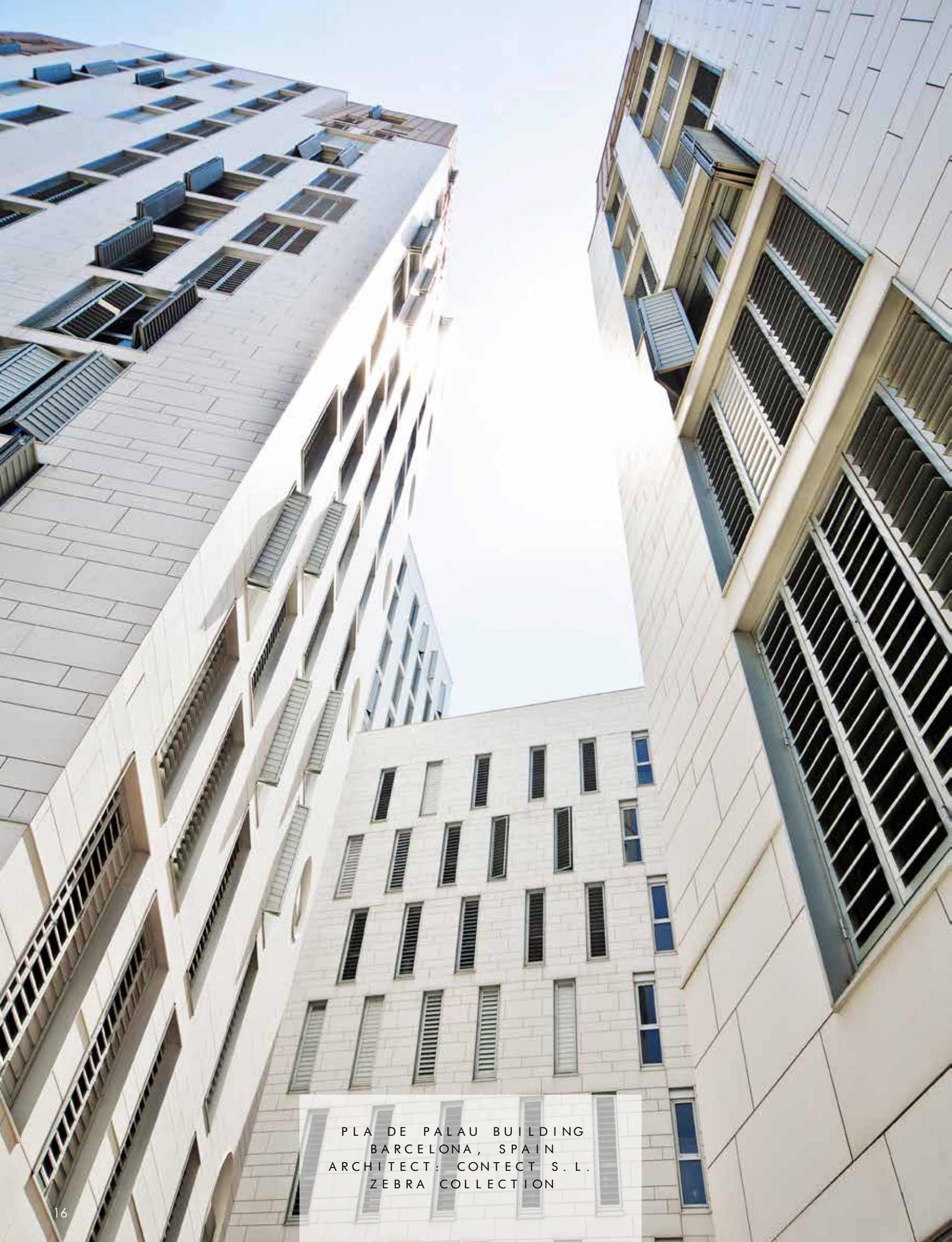

PLA DE PALAU BUILDING
BARCELONA, SPAIN
ARCHITECT: CONTECT S.L.
ZEBRA COLLECTION

PROJECTS

SOMOS PROYECTOS | NOUS SOMMES SYNONYME DE PROJECTS | WIR STEHEN FÜR PROJECTS

www.kerabenprojects.com

Public buildings, Hotels & Restaurants, Commercial areas, Residential projects, Offices

Edificios públicos, Hoteles y restaurantes, Superficies comerciales, Proyectos residenciales, Oficinas

Bâtiments publics, Hôtels et restaurants, Centres commerciaux, Projets résidentiels, Bureaux

Öffentliche Gebäude, Hotels und Restaurants, Einkaufszentren, Wohnprojekte, Büroräume

MURO & MOSAIC

Tile compositions made up of small mosaic chips, creating a sense of dynamism and compositional interplay. Design features that can be incorporated in larger designs to unique effect.

Composiciones creadas a partir de pequeñas teselas que generan juegos compositivos con movimiento. Fragmentos de diseño que unidos dan lugar a un conjunto repleto de singulares detalles.



FINISHES

ACABADOS

FINITIONS

VERARBEITUNGEN



NATURAL

The finish characteristic of the material that the tiles emulate.

Acabado propio del material en el que se inspira la pieza.

Finition propre au matériau dont la pièce s'inspire.

Die Ausführung des Materials, an dem das Teil inspiriert ist



SOFT

A very smooth matt lappato finish on surfaces with a relief texture.

Aspecto lappato mate de gran suavidad sobre superficies con relieve.

Aspect lappato mat d'une grande douceur sur des surfaces en relief.

Matter Lappato-Aspekt mit sehr zarter Wirkung auf Flächen mit Relief.



HONED

A more matt polished finish, with an extra silky appearance. Developed in house and unique to the sector.

Acabado pulido matificado. Un aspecto apomazado extra sedoso. Desarrollo propio y único en el sector.

Finition polie matifiée. Un aspect poncé extra soyeux. Développement propre et unique dans le secteur.

Polierte, mattierte Ausführung. Extra seidiges, geschmirgeltes Aussehen. Eigenentwicklung, die branchenweit einzigartig ist.



LAPPATO

Semi-polished floor tiles with a micro relief texture and unique shine.

Pavimento semipulido con microrelieve y un peculiar brillo.

Carrelage de sol semi-poli avec un microrelief et un brillant singulier.

Halbpolierte Bodenfliesen mit Mikrorelief und einem speziellen Glanz.



BRILLO

These tiles undergo a special process to give them a glossy shine.

Producto sometido a un proceso con el cual se consigue un efecto brillante.

Produit soumis à un procédé permettant d'obtenir un effet brillant.

Das Produkt wird einem Verfahren unterzogen, mit dem eine glänzende Wirkung erzielt wird.



ANTISLIP

Non-slip porcelain tiles, with a roughness imperceptible to the touch.

Porcelánico antideslizante con rugosidad imperceptible al tacto.

Grès cérame antidérapant avec une rugosité imperceptible au toucher.

Rutschhemmendes Feinsteinzeug mit einer Rauheit, die man nicht fühlen kann.



20MM THICKNESS

20MM ESPESORADO

ADVANTAGES VENTAJAS

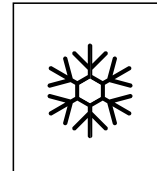
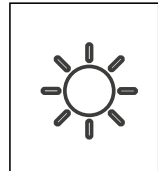
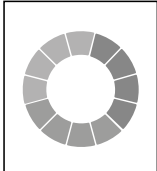
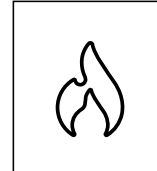
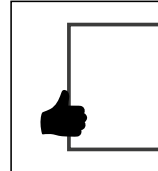
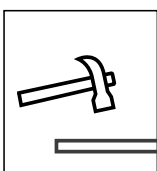
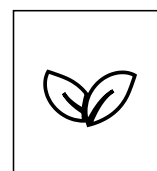
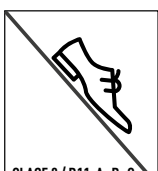
 Acid resistant Resistente al ácido	 Resists freezing temperatures Resistente a la helada	 Sun resistant Resistente al sol
 Colours remain stable over time Colores estables en el tiempo	 Fire resistant Resistente al fuego	 Easily replaced Fácilmente intercambiable
 High breaking load resistant Alta resistencia a la rotura	 Eco-friendly Ecológico	 CLASE 3 / R11 A+B+C Anti-slip Antideslizante

LAYING SUPPORTS ESPACIOS DE COLOCACIÓN

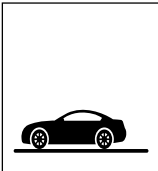
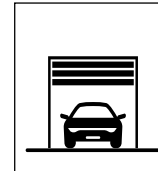
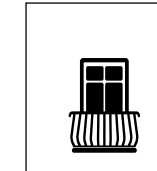
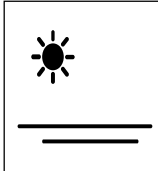
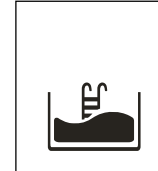
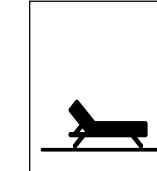
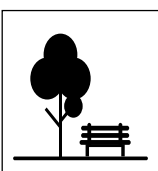
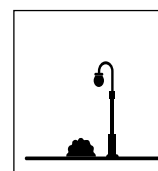
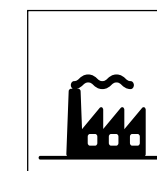
 Driveways Caminos de entrada	 Parking lots Parking	 Terraces Terrazas
 Beaches Playas	 Swimming pools Piscinas	 Resorts & spas Resorts y spas
 Parks & gardens Parques y jardines	 Urban decoration Decoración urbana	 Industrial zones Zonas industriales

WAYS OF LYING THE TILE TIPOS DE COLOCACIÓN

- 1** Bonded with adhesive
Instalación aplacado con cola
- 2** Over gravel or sand
Instalación sobre grava o arena
- 3** Grass
Instalación en césped
- 4** Raised
Instalación sobreelevada
- 5** Extension of standard flooring
Instalación interior-exterior



WALL TILES | MIXIT CONCEPT GRIS 30X90
 FLOOR TILES | MIXIT GRIS 75X75

COLLECTION INDEX

ÍNDICE DE COLECCIONES | SOMMAIRE COLLECTIONS | INHALTSANGABE NACH KOLLEKTIONEN

ALPINO	50	MADAGASCAR	210
ARABESCATTO	52	MADEIRA	214
ARDENNES	54	MILLENIUM	220
ATELIER	56	MISTERY	224
BEAUVAL	58	MISTRAL	226
BETON	64	MIXIT	228
BLANCOS	66	MOOD	240
BRANCATO	68	NATURE	244
CHELSEA	82	PALATINO	252
CHEVERNIE	84	PETIT GRANIT	256
COLOUR ME	90	PORTOBELLO	260
DIADEME	92	PRIORAT	264
DISTRICT	94	REMAKE	272
ELVEN	96	SAVIA	282
EVOLUTION	110	SOHO	288
EVOQUE	122	STONETECH	290
FRAME	148	TERMAE	292
FRESH	162	THAI	294
FUTURE	164	UPTOWN	296
JAZZ	182	URBAN	324
KURSAL	186	VELVET	328
LAVA	194	VILLAGE	330
LIVING	198	WALL BRICK	334
LOUNGE	206	ZEBRA	336

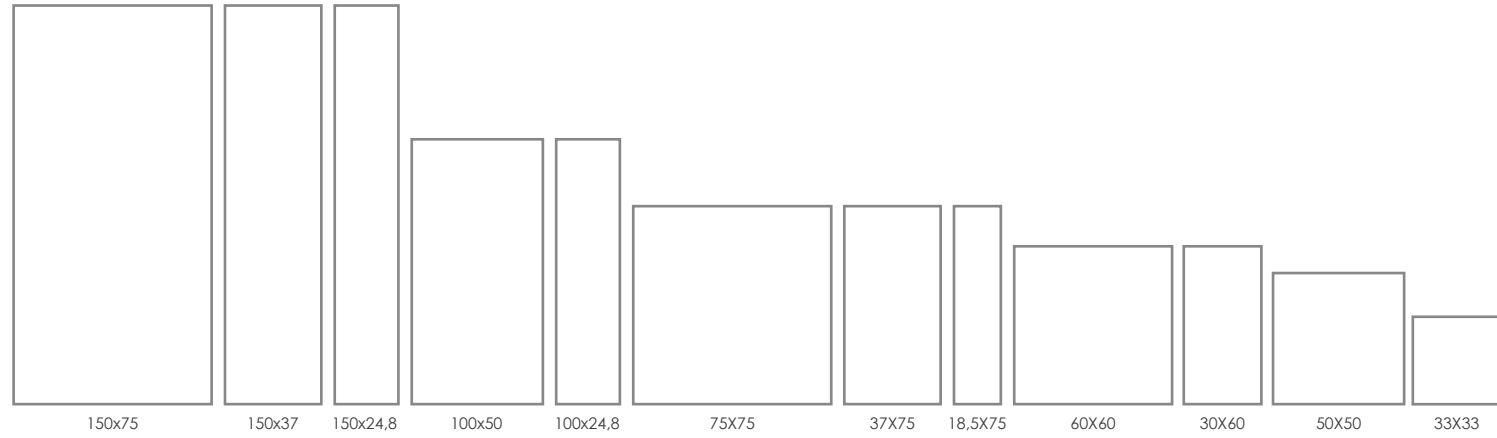

FLOOR TILES PAVIMENTOS

medida measure	collection serie	página page	collection serie	página page	collection serie	página page	collection serie	página page
RECTIFICADO 								
150x75 60"x30"	ELVEN	98						
150x37 60"x15"	EVOQUE UPTOWN	126 296						
150x24,8 60"x10"	SAVIA	282						
100x50 40"x20"	ALPINO BEAUVAL BRANCATO	50 58 68	EVOLUTION FUTURE KURSAL	110 164 186	LAVA NATURE URBAN	194 244 324	ZEBRA	336
100x24,8 40"x10"	ARDENNES MADEIRA	54 214	PORTOBELLO VILLAGE	260 330				
75x75 30"x30"	BRANCATO EVOLUTION EVOQUE	68 110 126	FRAME FUTURE LIVING	150 164 198	MADAGASCAR MIXIT NATURE	210 228 244	STONETECH UPTOWN	290 296
37x75 15"x30"	BRANCATO EVOLUTION EVOQUE	68 110 126	FRAME FUTURE LIVING	150 164 198	MADAGASCAR MIXIT NATURE	210 228 244	UPTOWN	296
73x73 28"x28"	BRANCATO HONED PALATINO	68 252						
36x73 14"x28"	BRANCATO HONED PALATINO	68 252						
18x73 7"x28"	BRANCATO HONED PALATINO	68 252						
60x60 24"x24"	ALPINO ARABESCATO BEAUVAL BRANCATO EVOLUTION	50 52 58 68 110	EVOQUE FRAME FUTURE JAZZ KURSAL	126 150 164 182 186	LAVA LIVING NATURE PETIT GRANIT PRIORAT	194 198 244 256 264	REMAKE STONETECH UPTOWN URBAN	272 290 296 324
30x60 12"x24"	ALPINO BEAUVAL BRANCATO	50 58 68	JAZZ KURSAL LAVA	182 186 194	PETIT GRANIT PRIORAT REMAKE	256 264 272	STONETECH URBAN	290 324
18,5x75 7"x30"	PORTOBELLO SAVIA VILLAGE	260 282 330						
NO RECTIFICADO								
33x33 13"x13"	CHEVERNIE TERMAE	84 292						
50x50 20"x20"	MATCH BRANCATO CHEVERNIE	56, 82, 90, 162, 206, 294, 328 68 84	DISTRICT FUTURE KURSAL	94 164 186	LIVING MISTRAL NATURE	198 224 244	SOHO TERMAE UPTOWN	288 292 296

SIZES INDEX

ÍNDICE POR FORMATOS | INDEX DES FORMATS | FORMATVERZEICHNIS

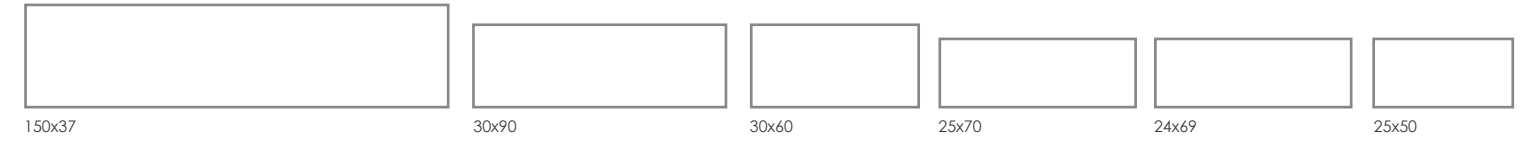

WALL TILES REVESTIMIENTOS

medida measure	collection serie	página page	collection serie	página page	collection serie	página page	collection serie	página page
RECTIFICADO 								
150x37 60"x15"	ELVEN EVOQUE UPTOWN	98 126 296						
30x90 12"x36"	BRANCATO CHELSEA EVOQUE FRAME	78 82 138 156	FUTURE MADEIRA MILLENIUM MYSTERY	174 218 220 224	MIXIT MOOD NATURE UPTOWN	234 240 250 314	VELVET WALL BRICK	328 334
30x60 12"x24"	BRANCATO EVOQUE	72 144						
24x69 9"x27"	BLANCOS	66						
NO RECTIFICADO								
25x70 10"x28"	ATELIER BEAUVAL BLANCOS DIADEME	56 62 66 92	EVOLUTION FRESH FUTURE LIVING	120 162 180 204	LOUNGE PRIORAT REMAKE	206 270 278	SOHO THAI	288 294
25x50 10"x20"	BETON BLANCOS BRANCATO	64 66 80	CHEVERNIE COLOURME DISTRICT	84 90 94	KURSAL MISTRAL TERMAE	192 226 292	UPTOWN	314

STYLE INDEX

ÍNDICE DE ESTILOS | SOMMAIRE STYLES | INHALTSANGABE NACH STILRICHTUNGEN

FLOOR TILES PAVIMENTOS

collection
serie

page
página

WALL TILES REVESTIMIENTOS

collection
serie

page
página

BEAUVAL	58
BRANCATO	68
LAVA	194
MADAGASCAR	210
MIXIT	228
PALATINO	252
PETIT GRANIT	256
PRIORAT	264
STONETECH	290
TERMAE	292

BEAUVAL	58
BRANCATO	68
MIXIT	228
MOOD	240
PRIORAT	264
TERMAE	292
WALL BRICK	334

ARDENNES	54
MADEIRA	214
PORTOBELLO	260
SAVIA	282
SOHO	288
VILLAGE	330

MADEIRA	214
SOHO	288

ELVEN	96
FUTURE	164
KURSAL	186

ELVEN	96
FUTURE	164
KURSAL	186

ALPINO	50
MISTRAL	226
NATURE	244

BLANCOS	66
MISTRAL	226
NATURE	244

FLOOR TILES PAVIMENTOS

collection
serie

page
página

WALL TILES REVESTIMIENTOS

collection
serie

page
página

DISTRICT	94
EVOLUTION	110
FRAME	148
JAZZ	182
LIVING	198
REMAKE	272
UPTOWN	296
URBAN	324

BETON	64
DISTRICT	94
EVOLUTION	110
FRAME	156
LIVING	204
REMAKE	278
UPTOWN	296

ARABESCATTO	52
CHEVERNIE	84
EVOQUE	122

CHEVERNIE	84
EVOQUE	122
MISTERY	224

ATELIER	56
CHELSEA	82
DIADEME	92
FRESH	162

ZEBRA	336
-------	-----

BLANCOS	66
COLOUR ME	90
LOUNGE	206
MILLENIUM	220
THAI	294
VELVET	328

STONE
PIEDRA

WOOD
MADERA

METAL
METAL

SLATE
PIZARRA

CONCRETE
CEMENTO

MARBLE
MÁRMOL

TEXTURE
TEXTURA

COLOUR
COLOR

APPLICATION INDEX

ÍNDICE DE USO TÉCNICO | SOMMAIRE USAGE | INHALTSANGABE NACH VERWENDUNGSMÖGLICHKEITEN

DIN-51130

Slip resistance
Resistencia al deslizamiento

R9

ALPINO NATURAL	50
ARDENNES NATURAL	54
BEAUVAL	58
BRANCATO NATURAL	68
EVOLUTION NATURAL	110
FRAME NATURAL	148
JAZZ NATURAL	182
LAVA NATURAL	194
LIVING NATURAL	198
MADEIRA NATURAL	214
MIXIT NATURAL	228
PETIT GRANIT NATURAL	256
PORTOBELLO NATURAL	260
PRIORAT NATURAL	264
REMAKE NATURAL	272
SAVIA NATURAL	282
STONETECH NATURAL	290
UPTOWN NATURAL	296
URBAN NATURAL	324
VILLAGE NATURAL	330

R10

EVOLUTION ANTISLIP	110
NATURE NATURAL	244
PRIORAT ANTISLIP	264
REMAKE ANTISLIP	272
UPTOWN ANTISLIP	296

R11

ARDENNES ANTISLIP	54
BEAUVAL ANTISLIP	58
BRANCATO ANTISLIP	72
BRANCATO 20 MM	72
FRAME ANTISLIP	148
FUTURE ANTISLIP	164
JAZZ OUTDOOR	182
LAVA OUTDOOR	194
MADEIRA ANTISLIP	214
MIXIT ANTISLIP	228
NATURE ANTISLIP	244
NATURE 20 MM	244
PORTOBELLO ANTISLIP	260
SAVIA ANTISLIP	282
STONETECH 20 MM	290
UPTOWN 20 MM	296
URBAN ANTISLIP	324

20MM

Porcelánico espesorado 20MM
Thick porcelain floor tile

BRANCATO 20 MM	72
NATURE 20 MM	244
STONETECH 20 MM	290
UPTOWN 20 MM	296

UNE-ENV 12633

Slip resistance
Resistencia al deslizamiento

CLASE 1

ALPINO NATURAL	50
ARDENNES NATURAL	54
BEAUVAL	58
BRANCATO NATURAL	72
EVOLUTION NATURAL	110
FRAME NATURAL	148
JAZZ NATURAL	182
LAVA NATURAL	194
MADEIRA NATURAL	214
MIXIT NATURAL	228
NATURE NATURAL	244
PETIT GRANIT NATURAL	256
PORTOBELLO NATURAL	260
PRIORAT NATURAL	264
REMAKE NATURAL	272
SAVIA NATURAL	282
STONETECH NATURAL	290
UPTOWN NATURAL	296
URBAN NATURAL	324

CLASE 2

LIVING NATURAL	198
----------------	-----

CLASE 3

ARDENNES ANTISLIP	54
BEAUVAL ANTISLIP	58
BRANCATO ANTISLIP	72
EVOLUTION ANTISLIP	110
FRAME ANTISLIP	148
FUTURE ANTISLIP	164
JAZZ OUTDOOR	182
LAVA OUTDOOR	194
MADEIRA ANTISLIP	214
MIXIT ANTISLIP	228
NATURE ANTISLIP	244
PORTOBELLO ANTISLIP	260
PRIORAT	264
REMAKE ANTISLIP	272
SAVIA ANTISLIP	282
STONETECH 20 MM	290
UPTOWN ANTISLIP	296
URBAN ANTISLIP	324

UPEC

Centre Scientifique et Technique du
Bâtiment (Francia)

BRANCATO	68
DISTRICT	94
EVOLUTION	110
FUTURE	164
KURSAL	186
LIVING	198
PRIORAT	264
REMAKE	272
UPTOWN	296

DIN-51097

Antislip properties wet-loaded
berefoot areas
Propiedades antideslizamiento a pie
descalzo

A+B

REMAKE ANTISLIP	272
-----------------	-----

A+B+C

ARDENNES ANTISLIP	54
BEAUVAL ANTISLIP	58
BRANCATO ANTISLIP	72
BRANCATO 20 MM	72
EVOLUTION ANTISLIP	110
FRAME ANTISLIP	148
FUTURE ANTISLIP	164
JAZZ OUTDOOR	182
LAVA OUTDOOR	194
MADEIRA ANTISLIP	214
MIXIT ANTISLIP	228
NATURE ANTISLIP	244
NATURE 20 MM	244
PORTOBELLO ANTISLIP	260
PRIORAT ANTISLIP	264
SAVIA ANTISLIP	282
STONETECH 20 MM	290
UPTOWN ANTISLIP	296
UPTOWN 20 MM	296
URBAN ANTISLIP	324

VENTILATED FACADES

Fachadas ventiladas

ALPINO	50
BEAUVAL	58
BRANCATO	68
EVOLUTION	110
FUTURE	164
KURSAL	186
LAVA	194
MADEIRA	214
NATURE	244
PORTOBELLO	260
URBAN	324
ZEBRA	336

USE

Uso

2		4		5					
ZEBRA	336	ARABESCATTO	52	ALPINO	50	MADAGASCAR	210		
		BRANCATO HONED	68	ARDENNES	54	MADEIRA	214		
3		DISTRICT	94	BEAUVAL	58	MIXIT	228		
MISTRAL	226	EVOQUE	122	BRANCATO	72	NATURE	244		
		MATCH	82, 90, 148, 206, 292	CHEVERNIE	84	PETIT GRANIT	256		
		PALATINO	252	ELVEN	96	PORTOBELLO	260		
		TERMAE	292	EVOLUTION	110	PRIORAT	264		
		UPTOWN	296	EVOQUE	122	REMAKE	272		
				FRAME	148	SAVIA	282		
				FUTURE	164	STONETECH	290		
				JAZZ	182	UPTOWN	296		
				KURSAL	186	URBAN	324		
				LAVA	194	VILLAGE	330		
				LIVING	198				

PRODUCT INDEX

ÍNDICE DE PRODUCTO | INDEX DES PRODUITS | PRODUKTVERZEICHNIS

Item Artículo	Size Formato	Group Grupo	Page Página	Item Artículo	Size Formato	Group Grupo	Page Página
A							
Alpino Negro	100x50	P100D	51	Beauval Crema	60x60	P64D	61
Alpino Negro	60x60	P64D	51	Beauval Crema	30x60	P34D	61
Alpino Negro	30x60	P34D	51	Beauval Crema	25x70	R27C	63
Arabescatto Blanco	60x60	P64C	53	Beauval Crema Antislip	60x60	P64E	61
Ardennes Blanco	100x24,8	P125D	55	Beauval Crema Antislip	30x60	P34E	61
Ardennes Crema	100x24,8	P125D	55	Beauval Crema Lappato	60x60	P64F	61
Ardennes Roble	100x24,8	P125D	55	Beauval Crema Lappato	30x60	P34F	61
Ardennes Roble Antislip	100x24,8	P125E	55	Beton Beige	25x50	R25C	65
Ardennes Tortora	100x24,8	P125D	55	Beton Blanco	25x50	R25C	65
Ardennes Tortora Antislip	100x24,8	P125E	55	Beton Gris	25x50	R25C	65
Ardennes Castaño	100x24,8	P125D	55	Beton Moka	25x50	R25C	65
Ardennes Century	100x24,8	P125D	55	Brancato Art Beige	30x90	R90H	79
Art Blanco	25x25	R25C	67	Brancato Beige	100x50	P100D	75
Atelier Beige	25x70	R27C	57	Brancato Beige	75x75	P75D	75
Atelier Blanco	25x70	R27C	57	Brancato Beige	60x60	P64D	75
Atlas Blanco	24x69	R69C	67	Brancato Beige	37x75	P37D	75
				Brancato Beige (PB)	30x90	R90D	79
				Brancato Beige	30x60	P34D	75
				Brancato Beige	30x60	R36D	79
				Brancato Beige	50x50	P50C	81
				Brancato Beige	25x50	R25C	81
B				Brancato Beige Antislip	75x75	P75E	75
Beauval Almond	100x50	P100D	60	Brancato Beige Antislip	60x60	P64E	75
Beauval Almond	60x60	P64D	60	Brancato Beige Antislip	37x75	P37E	75
Beauval Almond	30x60	P34D	60	Brancato Beige Antislip	30x60	P34E	75
Beauval Almond Antislip	60x60	P64E	60	Brancato Beige Honed	73x73	P75H	71
Beauval Almond Antislip	30x60	P34E	60	Brancato Beige Honed	36x73	P37H	71
Beauval Almond Lappato	60x60	P64F	60	Brancato Beige Honed	18x73	P18H	71
Beauval Almond Lappato	30x60	P34F	60	Brancato Beige Lappato	60x60	P64F	75
Beauval Blanco	100x50	P100D	59	Brancato Beige Lappato	30x60	P34F	75
Beauval Blanco	60x60	P64D	59	Brancato Beige 20 Mm	75x75	P75G	75
Beauval Blanco	30x60	P34D	59	Brancato Beige 20 Mm	60x60	P64G	75
Beauval Blanco	25x70	R27C	63	Brancato Blanco	100x50	P100D	74
Beauval Blanco Antislip	60x60	P64E	59	Brancato Blanco	75x75	P75D	74
Beauval Blanco Antislip	30x60	P34E	59	Brancato Blanco	60x60	P64D	74
Beauval Blanco Lappato	60x60	P64F	59	Brancato Blanco	37x75	P37D	74
Beauval Blanco Lappato	30x60	P34F	59	Brancato Blanco	30x60	P34D	74
Beauval Concept Blanco	25x70	R27G	63	Brancato Blanco (PB)	30x60	R36D	79
Beauval Concept Crema	25x70	R27G	63				
Beauval Crema	100x50	P100D	61				

Item Artículo	Size Formato	Group Grupo	Page Página	Item Artículo	Size Formato	Group Grupo	Page Página
				Chevernier Perla Mate	8X25	Y100	88
Brancato Blanco	30x90	R90D	79	Chevernier Crema Brillo	25x50	R25C	87
Brancato Blanco	50x50	P50C	81	Chevernier Crema Mate	50x50	P50D	87
Brancato Blanco	25x50	R25C	81	Chevernier Crema Mate	33x33	P33C	87
Brancato Blanco Antislip	75x75	P75E	74	Chevernier Crema Mate	25x50	R25C	87
Brancato Blanco Antislip	60x60	P64E	74	Chevernier Gris Brillo	25x50	R25C	86
Brancato Blanco Antislip	37x75	P37E	74	Chevernier Gris Mate	50x50	P50D	86
Brancato Blanco Antislip	30x60	P34E	74	Chevernier Gris Mate	33x33	P33C	86
Brancato Concept Beige	30x60	R36G	79	Chevernier Gris Mate	25x50	R25C	86
Brancato Concept Beige	25x50	R25G	81	Chevernier Perla Brillo	25x50	R25C	86
Brancato Concept Blanco	30x60	R36G	79	Chevernier Perla Mate	50x50	P50D	86
Brancato Concept Blanco	25x50	R25G	81	Chevernier Perla Mate	33x33	P33C	86
Brancato Concept Grafito	30x90	R90F	79	Chevernier Perla Mate	25x50	R25C	86
Brancato Concept Marrón	30x90	R90F	79	Colour Me Beige	25x50	R25C	91
Brancato Blanco Honed	73x73	P75H	70	Colour Me Blanco	25x50	R25C	91
Brancato Blanco Honed	36x73	P37H	70	Colour Me Concept Cobalto	25x50	R25G	91
Brancato Blanco Honed	18x73	P18H	70	Colour Me Concept Frambuesa	25x50	R25G	91
Brancato Blanco Lappato	60x60	P64F	74	Colour Me Concept Gris	25x50	R25G	91
Brancato Blanco Lappato	30x60	P34F	74	Colour Me Concept Lima	25x50	R25G	91
Brancato Gris	75x75	P75D	76	Colour Me Concept Visión	25x50	R25G	91
Brancato Gris	60x60	P64D	76	Crema Marfil	60x60	P64C	131
Brancato Gris	37x75	P37D	76	Crema Marfil	30x90	R90D	140
Brancato Gris	30x60	P34D	76	Cube Frame Beige	26x30	Y500	154
Brancato Gris Antislip	75x75	P75E	76	Cube Frame Blanco	26x30	Y500	152
Brancato Gris Antislip	37x75	P37E	76	Cube Frame Cemento	26x30	Y500	152
Brancato Gris Honed	73x73	P75H	70	Cube Frame Grafito	26x30	Y500	153
Brancato Gris Honed	36x73	P37H	70	Cube Frame Taupé	26x30	Y500	154
Brancato Gris Honed	18x73	P18H	70				
Bullnose Chevernier Crema Mate	5x25	S120	87	D			
Bullnose Chevernier Gris Mate	5x25	S120	86	Decor Battery Blanco	25x70	S600	289
Bullnose Chevernier Perla Mate	5x25	S120	86	Decor Battery Crema	25x70	S600	289
				Decor Blonda Blanco	25x70	S570	93
				Decor Blonda Crema	25x70	S570	93
				Decor Bloom Blanco	30x90	S670	329
				Decor Bloom Crema	30x90	S670	329
				Decor Boboli White	30x90	S670	225
				Decor Chelsea Cream	30x90	S690	83
				Decor Chelsea Snow	30x90	S690	83
				Decor Graffiti Gris	25x50	S540	65
C							
Chelsea Cream	30x90	R90C	83				
Chelsea Snow	30x90	R90C	83				
Chevernier Crema Brillo	8X25	Y100	88				
Chevernier Crema Mate	8X25	Y100	88				
Chevernier Gris Brillo	8X25	Y100	88				
Chevernier Gris Mate	8X25	Y100	88				
Chevernier Perla Brillo	8X25	Y100	88				

Item Artículo	Size Formato	Group Grupo	Page Página
Decor Graffiti Moka	25x50	S540	65
Decor Nippon Beige	25x70	S610	163
Decor Nippon Blanco	25x70	S610	163
Decor Noor Beige	30x90	S600	179
Decor Piaget Blanco Mate	30x90	S630	142
Decor Piaget Crema Mate	30x90	S630	143
Decor Sarga Marrón	25x25	S470	57
Decor Sarga Negro	25x25	S470	57
Diademe Blanco	25x70	R27C	93
Diademe Concept Aguamarina	25x70	R27G	93
Diademe Concept Champagne	25x70	R27G	93
Diademe Concept Malva	25x70	R27G	93
Diademe Crema	25x70	R27C	93
District Beige	25x50	R25C	95
District Blanco	25x50	R25C	95
District Concept Gris	25x50	R25G	95
District Concept Visón	25x50	R25G	95
District Gris	50x50	P50C	95
District Gris	25x50	R25C	95
District Visón	50x50	P50C	95
District Visón	25x50	R25C	95

E

Elven Beige Lappato	150x75	P575F	102
Elven Beige Lappato	150x37	P537F	102, 109
Elven Blanco Lappato	150x75	P575F	100
Elven Blanco Lappato	150x37	P537F	100, 108
Elven Concept Beige Lappato	150x37	P537H	109
Elven Concept Blanco Lappato	150x37	P537H	108
Elven Concept Grafito Lappato	150x37	P537H	108
Elven Concept Óxido Lappato	150x37	P537H	109
Elven Grafito Lappato	150x75	P575F	101
Elven Grafito Lappato	150x37	P537F	101, 108
Elven Óxido Lappato	150x75	P575F	103
Elven Óxido Lappato	150x37	P537F	103, 109
Evolution Beige	100x50	P100C	116
Evolution Beige	75x75	P75C	116
Evolution Beige	60x60	P64C	116
Evolution Beige	37x75	P37C	116

Item Artículo	Size Formato	Group Grupo	Page Página
Evolution Beige Antislip	75x75	P75E	116
Evolution Beige Antislip	37x75	P37E	116
Evolution Beige Lappato	75x75	P75F	116
Evolution Beige Lappato	60x60	P64F	116
Evolution Beige Lappato	37x75	P37F	116
Evolution Blanco	100x50	P100C	112
Evolution Blanco	75x75	P75C	112
Evolution Blanco	60x60	P64C	112
Evolution Blanco	37x75	P37C	112
Evolution Blanco Lappato	75x75	P75F	112
Evolution Blanco Lappato	60x60	P64F	112
Evolution Blanco Lappato	37x75	P37F	112
Evolution Grafito	100x50	P100D	114
Evolution Grafito	75x75	P75D	114
Evolution Grafito	60x60	P64D	114
Evolution Grafito	37x75	P37D	114
Evolution Grafito Antislip	75x75	P75E	114
Evolution Grafito Antislip	37x75	P37E	114
Evolution Grafito Lappato	75x75	P75F	114
Evolution Grafito Lappato	60x60	P64F	114
Evolution Grafito Lappato	37x75	P37F	114
Evolution Gris	100x50	P100C	113
Evolution Gris	75x75	P75C	113
Evolution Gris	60x60	P64C	113
Evolution Gris	37x75	P37C	113
Evolution Gris Antislip	75x75	P75E	113
Evolution Gris Antislip	37x75	P37E	113
Evolution Gris Lappato	75x75	P75F	113
Evolution Gris Lappato	60x60	P64F	113
Evolution Gris Lappato	37x75	P37F	113
Evolution Negro	100x50	P100D	115
Evolution Negro	75x75	P75D	115
Evolution Negro	60x60	P64D	115
Evolution Negro	37x75	P37D	115
Evolution Negro Lappato	75x75	P75F	115
Evolution Negro Lappato	60x60	P64F	115
Evolution Negro Lappato	37x75	P37F	115
Evolution Taupé	100x50	P100D	117
Evolution Taupé	75x75	P75D	117
Evolution Taupé	60x60	P64D	117
Evolution Taupé	37x75	P37D	117

Item Artículo	Size Formato	Group Grupo	Page Página
Evolution Taupé Antislip	75x75	P75E	117
Evolution Taupé Antislip	37x75	P37E	117
Evolution Taupé Lappato	75x75	P75F	117
Evolution Taupé Lappato	60x60	P64F	117
Evolution Taupé Lappato	37x75	P37F	117
Evolution Concept Cream	25x70	R27G	121
Evolution Concept Gris	25x70	R27G	121
Evolution Concept White	25x70	R27G	121
Evolution Concept Taupé	25x70	R27G	121
Evolution Cream	25x70	R27C	121
Evolution Gris	25x70	R27D	121
Evolution Taupé	25x70	R27D	121
Evolution White	25x70	R27C	121
Evoque Art Blanco Brillo	30x90	R90G	140
Evoque Art Blanco Mate	30x90	R90G	142
Evoque Art Crema Brillo	30x90	R90G	140
Evoque Art Crema Mate	30x90	R90G	143
Evoque Blanco Brillo	75x75	P75C	129
Evoque Blanco Brillo	60x60	P64C	129
Evoque Blanco Brillo	37x75	P37C	129
Evoque Blanco Brillo	30x90	R90D	140
Evoque Blanco Brillo	30x60	R36D	145
Evoque Blanco Brillo	8x25	Y100	147
Evoque Blanco Mate	150x75	P575C	128
Evoque Blanco Mate	150x37	P537C	128, 137
Evoque Blanco Mate	75x75	P75C	129
Evoque Blanco Mate	60x60	P64C	129
Evoque Blanco Mate	37x75	P37C	129
Evoque Blanco Mate	30x90	R90C	141, 142
Evoque Blanco Mate	30x60	R36C	145
Evoque Blanco Mate	8x25	Y100	147
Evoque Concept Blanco Brillo	30x90	R90G	140
Evoque Concept Blanco Brillo	30x60	R36G	145
Evoque Concept Blanco Mate	150x37	P537G	137
Evoque Concept Blanco Mate	30x90	R90G	141
Evoque Concept Blanco Mate	30x60	R36G	145
Evoque Concept Crema Brillo	30x90	R90G	140
Evoque Concept Crema Brillo	30x60	R36G	145
Evoque Concept Crema Mate	30x90	R90G	141
Evoque Concept Crema Mate	30x60	R36G	145
Evoque Concept Marfil Mate	150x37	P537G	137

F

Evoque Crema Brillo	75x75	P75C	133
Evoque Crema Brillo	37x75	P37C	133
Evoque Crema Brillo	30x60	R36D	145
Evoque Crema Mate	75x75	P75C	133
Evoque Crema Mate	60x60	P64C	133
Evoque Crema Mate	37x75	P37C	133
Evoque Crema Mate	30x90	R90C	141, 143
Evoque Crema Mate	30x60	R36C	145
Evoque Gris Brillo	75x75	P75C	132
Evoque Gris Brillo	37x75	P37C	132
Evoque Gris Mate	75x75	P75C	132
Evoque Gris Mate	37x75	P37C	132
Evoque Marfil Brillo	75x75	P75C	131
Evoque Marfil Brillo	37x75	P37C	131
Evoque Marfil Mate	150x75	P575C	130
Evoque Marfil Mate	150x37	P537C	130, 137
Evoque Marfil Mate	75x75	P75C	131
Evoque Marfil Mate	37x75	P37C	131

Fox Blanco	25x25	R25C	67
Frame Art Beige	30x90	R90H	161
Frame Art Blanco	30x90	R90H	161
Frame Beige	75x75	P75D	154
Frame Beige	60x60	P64D	154
Frame Beige	37x75	P37D	154
Frame Beige	30x90	R90D	161
Frame Beige Antislip	75x75	P75E	154
Frame Beige Antislip	37x75	P37E	154
Frame Blanco	75x75	P75D	152
Frame Blanco	60x60	P64D	152
Frame Blanco	37x75	P37D	152
Frame Blanco	30x90	R90D	161
Frame Cemento	75x75	P75D	152
Frame Cemento	60x60	P64D	152
Frame Cemento	37x75	P37D	152
Frame Cemento Antislip	75x75	P75E	152
Frame Cemento Antislip	37x75	P37E	152
Frame Concept Beige	30x90	R90G	161

Item Artículo	Size Formato	Group Grupo	Page Página
Frame Concept Blanco	30x90	R90G	161
Frame Concept Cemento	30x90	R90G	161
Frame Concept Taupé	30x90	R90G	161
Frame Grafito	75x75	P75D	153
Frame Grafito	60x60	P64D	153
Frame Grafito	37x75	P37D	153
Frame Grafito Antislip	75x75	P75E	153
Frame Grafito Antislip	37x75	P37E	153
Frame Taupé	75x75	P75D	154
Frame Taupé	60x60	P64D	154
Frame Taupé	37x75	P37D	154
Fresh Beige	25x70	R27C	163
Fresh Blanco	25x70	R27C	163
Fresh Grafito	25x70	R27C	163
Fresh Modul Grafito	25x70	R27E	163
Fresh Modul Visón	25x70	R27E	163
Fresh Visón	25x70	R27C	163
Future Beige	100x50	P100C	166
Future Beige	75x75	P75C	166
Future Beige	60x60	P64C	166
Future Beige	50x50	P50C	180
Future Beige	37x75	P37C	166
Future Beige	30x90	R90D	177, 179
Future Beige	25x70	R27D	181
Future Beige Antislip	75x75	P75E	166
Future Beige Antislip	37x75	P37E	166
Future Beige Lappato	100x50	P100E	166
Future Beige Lappato	75x75	P75F	166
Future Beige Lappato	60x60	P64F	166
Future Beige Lappato	37x75	P37F	166
Future Blanco	100x50	P100C	168
Future Blanco	75x75	P75C	168
Future Blanco	60x60	P64C	168
Future Blanco	50x50	P50C	180
Future Blanco	37x75	P37C	168
Future Blanco	30x90	R90D	177
Future Blanco	25x70	R27D	181
Future Blanco Lappato	100x50	P100E	168
Future Blanco Lappato	75x75	P75F	168
Future Blanco Lappato	60x60	P64F	168
Future Blanco Lappato	37x75	P37F	168
Future Cobre	100x50	P100C	167

Item Artículo	Size Formato	Group Grupo	Page Página
Future Cobre	75x75	P75D	167
Future Cobre	60x60	P64D	167
Future Cobre	50x50	P50D	180
Future Cobre	37x75	P37D	167
Future Cobre	25x70	R27D	181
Future Cobre Lappato	100x50	P100E	167
Future Cobre Lappato	75x75	P75F	167
Future Cobre Lappato	60x60	P64F	167
Future Cobre Lappato	37x75	P37F	167
Future Concept Beige	30x90	R90F	177
Future Concept Blanco	30x90	R90F	177
Future Concept Cobre	30x90	R90F	177
Future Concept Cobre	25x70	R27G	181
Future Concept Óxido	30x90	R90F	177
Future Concept Óxido	25x70	R27G	181
Future Grafito	100x50	P100D	170
Future Grafito	75x75	P75D	170
Future Grafito	60x60	P64D	170
Future Grafito	37x75	P37D	170
Future Grafito Antislip	75x75	P75E	170
Future Grafito Antislip	37x75	P37E	170
Future Grafito Lappato	100x50	P100E	170
Future Grafito Lappato	75x75	P75F	170
Future Grafito Lappato	60x60	P64F	170
Future Grafito Lappato	37x75	P37F	170
Future Gris	100x50	P100C	169
Future Gris	75x75	P75C	169
Future Gris	60x60	P64C	169
Future Gris	50x50	P50D	180
Future Gris	37x75	P37C	169
Future Gris	25x70	R27D	181
Future Gris Antislip	75x75	P75E	169
Future Gris Antislip	37x75	P37E	169
Future Gris Lappato	100x50	P100E	169
Future Gris Lappato	75x75	P75F	169
Future Gris Lappato	60x60	P64F	169
Future Gris Lappato	37x75	P37F	169
Future Negro	100x50	P100D	171
Future Negro	75x75	P75D	171
Future Negro	60x60	P64D	171
Future Negro	37x75	P37D	171
Future Negro Lappato	100x50	P100E	171

Item Artículo	Size Formato	Group Grupo	Page Página
Future Negro Lappato	75x75	P75F	171
Future Negro Lappato	60x60	P64F	171
Future Negro Lappato	37x75	P37F	171
Future Óxido	100x50	P100D	172
Future Óxido	75x75	P75D	172
Future Óxido	60x60	P64D	172
Future Óxido	50x50	P50D	180
Future Óxido	37x75	P37D	172
Future Óxido	25x70	R27D	181
Future Óxido Lappato	100x50	P100E	172
Future Óxido Lappato	75x75	P75F	172
Future Óxido Lappato	60x60	P64F	172
Future Óxido Lappato	37x75	P37F	172
Geo Blanco	25x70	R27C	67
Jazz Blanco	60x60	P64C	184
Jazz Blanco	30x60	P34C	184
Jazz Blanco Outdoor	60x60	P64D	184
Jazz Grafito	60x60	P64D	185
Jazz Grafito	30x60	P34D	185
Jazz Grafito Outdoor	60x60	P64E	185
Jazz Greige	60x60	P64C	185
Jazz Greige	30x60	P34C	185
Jazz Greige Outdoor	60x60	P64D	185
Jazz Gris	60x60	P64C	184
Jazz Gris	30x60	P34C	184
Jazz Gris Outdoor	60x60	P64D	184
Kursal Beige	100x50	P100C	189
Kursal Beige	60x60	P64C	189
Kursal Beige	50x50	P50D	193
Kursal Beige	30x60	P34C	189

Item Artículo	Size Formato	Group Grupo	Page Página
Kursal Beige	25x50	R25C	193
Kursal Blanco	100x50	P100C	188
Kursal Blanco	60x60	P64C	188
Kursal Blanco	50x50	P50D	193
Kursal Blanco	30x60	P34C	188
Kursal Blanco	25x50	R25C	193
Kursal Gris	100x50	P100C	188
Kursal Gris	60x60	P64C	188
Kursal Gris	50x50	P50D	193
Kursal Gris	30x60	P34C	188
Kursal Gris	25x50	R25C	193
Kursal Moka	100x50	P100D	189
Kursal Moka	60x60	P64D	189
Kursal Moka	50x50	P50D	193
Kursal Moka	30x60	P34D	189
Kursal Moka	25x50	R25D	193
Kursal Óxido	100x50	P100D	190
Kursal Óxido	60x60	P64D	190
Kursal Óxido	50x50	P50D	193
Kursal Óxido	30x60	P34D	190
Kursal Óxido	25x50	R25D	193
Lava Blanco	100x50	P100D	196
Lava Blanco	60x60	P64D	196
Lava Blanco	30x60	P34D	196
Lava Grafito	100x50	P100F	197
Lava Grafito	60x60	P64E	197
Lava Grafito	30x60	P34E	197
Lava Gris	100x50	P100D	196
Lava Gris	60x60	P64D	196
Lava Gris	30x60	P34D	196
Lava Gris Outdoor	60x60	P64D	196
Lava Gris Outdoor	30x60	P34D	196
Lava Negro	100x50	P100F	197
Lava Negro	60x60	P64E	197
Lava Negro	30x60	P34E	197
Líneas Living Negro	25x70	R27F	205
Líneas Soho Arena	25x70	R27F	289
Líneas Soho Gris	25x70	R27F	289

Item Artículo	Size Formato	Group Grupo	Page Página
Listelo Amiens Blanco	5x36	S390	63
Listelo Amiens Crema	5x36	S390	63
Listelo Blonda Blanco	4,6x70	S430	93
Listelo Blonda Crema	4,6x70	S430	93
Listelo Bloom Grafito	5,8x90	S530	329
Listelo Bloom Marrón	5,8x90	S530	329
Listelo Boboli Flow White	8,5x30	S480	225
Listelo Boboli White	8,5x30	S520	225
Listelo Brancato Beige	4x50	S340	81
Listelo Brancato Blanco	4x50	S340	81
Listelo Chelsea Brown	6,9x90	S570	83
Listelo Chelsea Dark	6,9x90	S570	83
Listelo Chevernie Crema	5,8x25	S260	87
Listelo Chevernie Gris	5,8x25	S260	86
Listelo Colour Me Cobalto	3,8x50	S320	91
Listelo Colour Me Frambuesa	3,8x50	S320	91
Listelo Colour Me Gris	3,8x50	S320	91
Listelo Colour Me Lima	3,8x50	S320	91
Listelo Colour Me Visón	3,8x50	S320	91
Listelo District Gris	4,6x50	S320	95
Listelo District Visón	4,6x50	S320	95
Listelo Evoque Art Blanco Brillo	4,5x90	S490	140, 141
Listelo Evoque Art Crema Brillo	4,5x90	S490	140, 141
Listelo Flora	11,8x70	S540	295
Listelo Folk Gris	12x50	S440	193
Listelo Folk Moka	12x50	S440	193
Listelo Graffiti Gris	3,8x50	S270	65
Listelo Graffiti Moka	3,8x50	S270	65
Listelo Kala Negro	11,8x70	S500	295
Listelo Kala Negro	3,8x70	S380	295
Listelo Kubán Black	7x30	S320	142
Listelo Kubán Brown	7x30	S320	143
Listelo Motion Azul	7,8x70	S480	208
Listelo Motion Gris	7,8x70	S480	209
Listelo Motion Malva	7,8x70	S480	208
Listelo Motion Marrón	7,8x70	S480	209
Listelo Motion Rojo	7,8x70	S480	209
Listelo Palatino Beige	5x36	S420	255
Listelo Palatino Grey	5x36	S420	254
Listelo Palatino White	5x36	S420	254
Listelo Piaget Gold	4,8x30	S460	143

Item Artículo	Size Formato	Group Grupo	Page Página
Listelo Piaget Silver	4,8x30	S460	142
Listelo Priorat Cemento	5,8x70	S490	271
Listelo Priorat Natural	5,8x70	S490	271
Listelo Remake Gris	3,8x70	S350	281
Listelo Remake Visón	3,8x70	S350	281
Listelo Sarga Marrón	4,6x70	S420	57
Listelo Sarga Negro	4,6x70	S420	57
Listelo Sasha	4,8x30	S460	179
Listelo Soho Arena	3,8x70	S350	289
Listelo Soho Gris	3,8x70	S350	289
Listelo Spray Grafito	7,8x70	S470	163
Listelo Spray Visón	7,8x70	S470	163
Listelo Tarifa Moka	10x50	S520	227
Listelo Tarifa Negro	10x50	S520	227
Listelo Termae Beige	8,6x25	S320	293
Listelo Termae Grey	8,6x25	S320	293
Listelo Termae White	8,6x25	S320	293
Listelo Toussete Beige	4,8x30	S460	321
Listelo Toussete Grey	4,8x30	S460	321
Listelo Toussete White	4,8x30	S460	321
Listelo Uptown Art Gold	7x30	S320	321
Listelo Uptown Art Silver	7x30	S320	321
Listelo Uptown Beige	4,6x50	S230	323
Listelo Uptown Grey	4,6x50	S230	323
Listelo Uptown White	4,6x50	S230	323
Listelo Xilo Marrón	7,8x70	S490	205
Listelo Xilo Negro	7,8x70	S490	205
Living Beige	75x75	P75C	202
Living Beige	60x60	P64C	202
Living Beige C1	50x50	P50D	205
Living Beige	37x75	P37C	202
Living Beige	25x70	R27C	205
Living Beige Lappato	75x75	P75F	202
Living Beige Lappato	60x60	P64F	202
Living Beige Lappato	37x75	P37F	202
Living Blanco	75x75	P75C	200
Living Blanco	60x60	P64C	200
Living Blanco C1	50x50	P50D	205
Living Blanco	37x75	P37C	200
Living Blanco	25x70	R27C	205
Living Blanco Lappato	75x75	P75F	200
Living Blanco Lappato	60x60	P64F	200

Item Artículo	Size Formato	Group Grupo	Page Página
Living Blanco Lappato	37x75	P37F	200
Living Grafito	75x75	P75D	201
Living Grafito	60x60	P64D	201
Living Grafito C1	50x50	P50D	205
Living Grafito	37x75	P37D	201
Living Grafito Lappato	75x75	P75F	201
Living Grafito Lappato	60x60	P64F	201
Living Grafito Lappato	37x75	P37F	201
Living Gris	75x75	P75C	200
Living Gris	60x60	P64C	200
Living Gris C1	50x50	P50D	205
Living Gris	37x75	P37C	200
Living Gris Lappato	75x75	P75F	200
Living Gris Lappato	60x60	P64F	200
Living Gris Lappato	37x75	P37F	200
Living Marrón	60x60	P64D	202
Living Marrón Lappato	60x60	P64F	202
Living Negro	60x60	P64D	201
Living Negro C1	50x50	P50D	205
Living Negro Lappato	60x60	P64F	201
Lounge Azul	25x70	R27D	208
Lounge Blanco	25x70	R27C	208, 209
Lounge Concept Azul	25x70	R27G	208
Lounge Concept Gris	25x70	R27G	209
Lounge Concept Malva	25x70	R27G	208
Lounge Crema	25x70	R27C	209
Lounge Gris	25x70	R27D	209
Lounge Malva	25x70	R27D	208
Madagascar Cream	75x75	P75C	213
Madagascar Cream	37x75	P37C	213
Madagascar Grey	75x75	P75C	212
Madagascar Grey	37x75	P37C	212
Madagascar White	75x75	P75C	212
Madagascar White	37x75	P37C	212
Madeira Blanco	100x24,8	P125D	216, 217
Madeira Blanco	30x90	R90C	219
Madeira Blanco Lappato	100x24,8	P125F	216, 217

M

Item Artículo	Size Formato	Group Grupo	Page Página
Madeira Ceniza	100x24,8	P125D	216, 217
Madeira Crema	100x24,8	P125D	216, 217
Madeira Crema	30x90	R90D	219
Madeira Crema Lappato	100x24,8	P125F	216, 217
Madeira Concept Grafito	30x90	R90F	219
Madeira Concept Roble	30x90	R90F	219
Madeira Grafito	100x24,8	P125D	216, 217
Madeira Grafito C-3	100x24,8	P125E	216, 217
Madeira Gris	100x24,8	P125D	216, 217
Madeira Gris Lappato	100x24,8	P125F	216, 217
Madeira Negro	100x24,8	P125D	216, 217
Madeira Negro Lappato	100x24,8	P125F	216, 217
Madeira Roble	100x24,8	P125D	216, 217
Madeira Roble C-3	100x24,8	P125E	216, 217
Madeira Roble Lappato	100x24,8	P125F	216, 217
Madeira Titanium	100x24,8	P125D	216, 217
Madeira Titanium C-3	100x24,8	P125E	216, 217
Madeira Titanium Lappato	100x24,8	P125F	216, 217
Madeira Toscana	100x24,8	P125D	216, 217
Madeira Toscana Lappato	100x24,8	P125F	216, 217
Malla Acero Bronce	30,5x32,5	S540	177, 181
Malla Acero Plata	30,5x32,5	S540	177, 181
Malla Fresh Grafito	30x30	S540	163
Malla Fresh Visón	30x30	S540	163
Malla Lounge Azul	30x30	S550	208
Malla Lounge Gris	30x30	S550	209
Malla Lounge Malva	30x30	S550	208
Malla Velvet Grafito	30x30	S550	329
Malla Velvet Marrón	30x30	S550	329
Match Antracita	50x50	P50D	209, 328
Match Cobalto	50x50	P50D	91, 208
Match Cream	50x50	P50D	162
Match Gris	50x50	P50D	83, 91
Match Marrón	50x50	P50D	57, 209, 328
Match Negro	50x50	P50D	57, 83, 91, 209, 295
Match Snow	50x50	P50D	83, 91, 162
Match Visón	50x50	P50D	83, 91
Match Púrpura	50x50	P50D	208
Millenium Blanco Brillo	30x90	R90D	223
Millenium Blanco Mate	30x90	R90D	223
Millenium Flow Blanco Brillo	30x90	R90F	223

Item Artículo	Size Formato	Group Grupo	Page Página
Millenium Flow Blanco Mate	30x90	R90F	223
Millenium Flow Negro Brillo	30x90	R90F	223
Millenium Flow Negro Mate	30x90	R90F	223
Millenium Quilt Blanco Brillo	30x90	R90F	223
Millenium Quilt Blanco Mate	30x90	R90F	223
Millenium Rubik Blanco Brillo	30x90	R90F	223
Millenium Rubik Blanco Mate	30x90	R90F	223
Mistery White	30x90	R90D	225
Mistral Beige	25x50	R25C	227
Mistral Blanco	25x50	R25C	227
Mistral Negro	50x50	P50C	227
Mistral Negro	25x50	R25D	227
Mixit Art Beige	30x90	R90H	239
Mixit Art Blanco	30x90	R90H	238
Mixit Art Gris	30x90	R90H	238
Mixit Beige	75x75	P75C	233
Mixit Beige	37x75	P37C	233
Mixit Beige	30x90	R90C	239
Mixit Beige Antislip	75x75	P75E	233
Mixit Beige Antislip	37x75	P37E	233
Mixit Blanco	75x75	P75C	232
Mixit Blanco	37x75	P37C	232
Mixit Blanco	30x90	R90C	238
Mixit Blanco Antislip	75x75	P75E	232
Mixit Blanco Antislip	37x75	P37E	232
Mixit Concept Beige	30x90	R90G	239
Mixit Concept Blanco	30x90	R90G	238
Mixit Concept Gris	30x90	R90G	238
Mixit Grafito	75x75	P75C	233
Mixit Grafito	37x75	P37C	233
Mixit Grafito Antislip	75x75	P75E	233
Mixit Grafito Antislip	37x75	P37E	233
Mixit Gris	75x75	P75C	232
Mixit Gris	37x75	P37C	232
Mixit Gris	30x90	R90C	238
Mixit Gris Antislip	75x75	P75E	232
Mixit Gris Antislip	37x75	P37E	232
Mood Blanco	30x90	R90C	243
Mood Oblique Blanco	30x90	R90G	243
Mood Oceanic Blanco	30x90	R90G	243
Mood Strata Blanco	30x90	R90G	243

Item Artículo	Size Formato	Group Grupo	Page Página
Mosaico Alpino Negro	30x30	Y500	51
Mosaico Beauval Almond	30x30	Y600	60
Mosaico Beauval Blanco	30x30	Y600	59, 63
Mosaico Beauval Crema	30x30	Y600	61, 63
Mosaico Brancato Beige	30x30	Y600	75
Mosaico Brancato Blanco	30x30	Y600	74
Mosaico Brancato Gris	30x30	Y600	76
Mosaico Chevernie Crema Mate	33x33	Y300	87
Mosaico Chevernie Gris Mate	33x33	Y300	86
Mosaico Chevernie Perla Mate	33x33	Y300	86
Mosaico Evolution Beige	30x30	Y300	116
Mosaico Evolution Blanco	30x30	Y300	112
Mosaico Evolution Grafito	30x30	Y300	114
Mosaico Evolution Gris	30x30	Y300	113
Mosaico Evolution Negro	30x30	Y300	115
Mosaico Evolution Taupé	30x30	Y300	117
Mosaico Evoque Blanco Mate	30x30	Y300	129
Mosaico Evoque Crema Mate	30x30	Y300	133
Mosaico Evoque Marfil Mate	30x30	Y300	131
Mosaico Evoque Gris Mate	30x30	Y300	132
Mosaico Future Blanco	30x30	Y600	168
Mosaico Future Beige	30x30	Y600	166
Mosaico Future Cobre	30x30	Y600	167
Mosaico Future Grafito	30x30	Y600	170
Mosaico Future Gris	30x30	Y600	169
Mosaico Future Negro	30x30	Y600	171
Mosaico Future Óxido	30x30	Y600	172
Mosaico Jazz Blanco	30x30	Y500	184
Mosaico Jazz Grafito	30x30	Y500	185
Mosaico Jazz Greige	30x30	Y500	185
Mosaico Jazz Gris	30x30	Y500	184
Mosaico Lava Grafito	30x30	Y600	197
Mosaico Lava Negro	30x30	Y600	197
Mosaico Lava Gris	30x30	Y600	196
Mosaico Living Beige	30x30	Y500	202
Mosaico Living Blanco	30x30	Y500	200
Mosaico Living Grafito	30x30	Y500	201
Mosaico Living Gris	30x30	Y500	200
Mosaico Living Marrón	30x30	Y500	202
Mosaico Living Negro	30x30	Y500	201
Mosaico Madagascar Cream	30x30	Y300	213

Item Artículo	Size Formato	Group Grupo	Page Página
Mosaico Madagascar Grey	30x30	Y300	212
Mosaico Madagascar White	30x30	Y300	212
Mosaico Mixit Beige	30x30	Y300	233
Mosaico Mixit Blanco	30x30	Y300	232
Mosaico Mixit Grafito	30x30	Y300	233
Mosaico Mixit Gris	30x30	Y300	232
Mosaico Nature Beige	30x30	Y500	249
Mosaico Nature Black	30x30	Y500	248
Mosaico Nature Bone	30x30	Y500	246
Mosaico Nature Grey	30x30	Y500	247
Mosaico Palatino Beige Honed	30x30	Y500	255
Mosaico Palatino Grey Honed	30x30	Y500	254
Mosaico Palatino White Honed	30x30	Y500	254
Mosaico Petit Granit Crema	30x30	Y600	259
Mosaico Petit Granit Grafito	30x30	Y600	258
Mosaico Petit Granit Gris	30x30	Y600	258
Mosaico Petit Granit Moka	30x30	Y600	259
Mosaico Petit Granit Negro	30x30	Y600	258
Mosaico Petit Granit Visón	30x30	Y600	259
Mosaico Priorat Beige	30x30	Y300	268
Mosaico Priorat Blanco	30x30	Y300	266
Mosaico Priorat Cemento	30x30	Y300	266
Mosaico Priorat Grafito	30x30	Y300	267
Mosaico Priorat Natural	30x30	Y300	268
Mosaico Remake Blanco	30x30	Y300	276
Mosaico Remake Crema	30x30	Y300	277
Mosaico Remake Gris	30x30	Y300	276
Mosaico Remake Visón	30x30	Y300	277
Mosaico Termae Beige	33x33	Y300	293
Mosaico Termae Grey	33x33	Y300	293
Mosaico Termae White	33x33	Y300	293
Mosaico Uptown Beige	30x30	Y300	305
Mosaico Uptown Black	30x30	Y300	306
Mosaico Uptown Grey	30x30	Y300	303
Mosaico Uptown White	30x30	Y300	301
Mosaico Urban Beige	30x30	Y500	325
Mosaico Urban Grafito	30x30	Y500	326
Mosaico Urban Gris	30x30	Y500	326
Mosaico Urban Negro	30x30	Y500	327
Muro Beauveal Almond	30x64	Y500	60
Muro Beauveal Blanco	30x64	Y500	59, 63

Item Artículo	Size Formato	Group Grupo	Page Página
Muro Beauveal Crema	30x64	Y500	61, 63
Muro Brancato Beige	30x64	Y500	75
Muro Brancato Blanco	30x64	Y500	74
Muro Brancato Gris	30x64	Y500	76
Muro Future Blanco	26x58	Y500	168
Muro Future Beige	26x58	Y500	166
Muro Future Cobre	26x58	Y500	167
Muro Future Grafito	26x58	Y500	170
Muro Future Gris	26x58	Y500	169
Muro Future Negro	26x58	Y500	171
Muro Future Óxido	26x58	Y500	172
Muro Madagascar Cream	26x58	Y500	213
Muro Madagascar Grey	26x58	Y500	212
Muro Madagascar White	26x58	Y500	212
Muro Mixit Beige	26x58	Y500	233
Muro Mixit Blanco	26x58	Y500	232
Muro Mixit Grafito	26x58	Y500	233
Muro Mixit Gris	26x58	Y500	232
Muro Nature Beige	26x58	Y500	249
Muro Nature Black	26x58	Y500	248
Muro Nature Bone	26x58	Y500	246
Muro Nature Grey	26x58	Y500	247
Muro Palatino Beige Honed	26x58	Y500	255
Muro Palatino Grey Honed	26x58	Y500	254
Muro Palatino White Honed	26x58	Y500	254
Muro Priorat Beige	22,8x39	Y300	268
Muro Priorat Blanco	22,8x39	Y300	266
Muro Priorat Cemento	22,8x39	Y300	266
Muro Priorat Grafito	22,8x39	Y300	267
Muro Priorat Natural	22,8x39	Y300	268
Nature Beige	100x50	P100C	249
Nature Beige	75x75	P75C	249
Nature Beige	60x60	P64D	249
Nature Beige	37x75	P37C	249
Nature Black	100x50	P100D	248
Nature Black	75x75	P75D	248
Nature Black	60x60	P64E	248

N

Item Artículo	Size Formato	Group Grupo	Page Página
Nature Black	37x75	P37D	248
Nature Bone	100x50	P100C	246
Nature Bone	75x75	P75C	246
Nature Bone	60x60	P60D	246
Nature Bone	50x50	P50E	246
Nature Bone	37x75	P37C	246
Nature Bone	30x90	R90D	251
Nature Bone Antislip	100x50	P100F	246
Nature Bone Antislip	75x75	P75E	246
Nature Bone Antislip	37x75	P37E	246
Nature Bone 20 Mm	75x75	P75G	246
Nature Bone 20 Mm	60x60	P64G	246
Nature Concept Bone	30x90	R90F	251
Nature Concept Grey	30x90	R90F	251
Nature Grey	100x50	P100C	247
Nature Grey	75x75	P75C	247
Nature Grey	60x60	P64D	247
Nature Grey	50x50	P50E	247
Nature Grey	37x75	P37C	247
Nature Grey	30x90	R90D	251
Nature Grey Antislip	100x50	P100F	247
Nature Grey Antislip	75x75	P75E	247
Nature Grey Antislip	37x75	P37E	247
Nature Grey 20 Mm	75x75	P75G	247
Nature Grey 20 Mm	60x60	P64G	247
Nova Blanco	25x70	R27C	67

P

Palatino Beige Honed	73x73	P75H	255
Palatino Beige Honed	36x73	P37H	255
Palatino Beige Honed	18x73	P18H	255
Palatino Grey Honed	73x73	P75H	254
Palatino Grey Honed	36x73	P37H	254
Palatino Grey Honed	18x73	P18H	254
Palatino White Honed	73x73	P75H	254
Palatino White Honed	36x73	P37H	254
Palatino White Honed	18x73	P18H	254
Perfil Acero Bronce	1,5x90	S330	79, 140, 141, 161, 177, 219, 239, 251, 319

Item Artículo	Size Formato	Group Grupo	Page Página
Perfil Acero Bronce	1,5x70	S300	121, 181, 281
Perfil Acero Bronce	1,5x60	S270	79, 145
Perfil Acero Bronce	1,5x50	S260	323
Perfil Acero Plata	1,5x90	S330	79, 140, 141, 161, 177, 219, 238, 243, 251, 318, 67, 121, 181, 281
Perfil Acero Plata	1,5x70	S300	79, 145
Perfil Acero Plata	1,5x60	S270	79, 145
Perfil Acero Plata	1,5x50	S260	67, 323
Perfil Metallic	2x90	S290	83, 225
Petit Granit Crema	60x60	P64D	259
Petit Granit Crema	30x60	P34D	259
Petit Granit Grafito	60x60	P64E	258
Petit Granit Grafito	30x60	P34E	258
Petit Granit Gris	60x60	P64E	258
Petit Granit Gris	30x60	P34E	258
Petit Granit Moka	60x60	P64E	259
Petit Granit Moka	30x60	P34E	259
Petit Granit Negro	60x60	P64E	258
Petit Granit Negro	30x60	P34E	258
Petit Granit Visón	60x60	P64E	259
Petit Granit Visón	30x60	P34E	259
Portobello Blanco	100x24,8	P125D	263
Portobello Blanco	18,5x75	P18D	263
Portobello Fresno	100x24,8	P125D	263
Portobello Fresno	18,5x75	P18D	263
Portobello Nogal	100x24,8	P125D	263
Portobello Nogal	18,5x75	P18D	263
Portobello Nogal Antislip	100x24,8	P125E	263
Portobello Roble	100x24,8	P125D	263
Portobello Roble	18,5x75	P18D	263
Portobello Roble Antislip	100x24,8	P125E	263
Portobello Roble Antislip	18,5x75	P18E	263
Priorat Beige	60x60	P64D	268
Priorat Beige	30x60	P34D	268
Priorat Beige	25x70	R27D	271
Priorat Beige Antislip	60x60	P64E	268
Priorat Beige Antislip	30x60	P34E	268
Priorat Blanco	60x60	P64D	266
Priorat Blanco	30x60	P34D	266
Priorat Blanco	25x70	R27D	271
Priorat Blanco Antislip	60x60	P64E	266

Item Artículo	Size Formato	Group Grupo	Page Página
Priorat Blanco Antislip	30x60	P34E	266
Priorat Cemento	60x60	P64D	266
Priorat Cemento	30x60	P34D	266
Priorat Cemento	25x70	R27D	271
Priorat Cemento Antislip	60x60	P64E	266
Priorat Cemento Antislip	30x60	P34E	266
Priorat Concept Beige	25x70	R27G	271
Priorat Concept Blanco	25x70	R27G	271
Priorat Concept Cemento	25x70	R27G	271
Priorat Concept Natural	25x70	R27G	271
Priorat Grafito	60x60	P64D	267
Priorat Grafito	30x60	P34D	267
Priorat Grafito Antislip	60x60	P64E	267
Priorat Grafito Antislip	30x60	P34E	267
Priorat Modul Beige	60x60	P64E	268
Priorat Modul Blanco	60x60	P64E	266
Priorat Modul Cemento	60x60	P64E	266
Priorat Modul Grafito	60x60	P64E	267
Priorat Modul Natural	60x60	P64E	268
Priorat Natural	60x60	P64D	268
Priorat Natural	30x60	P34D	268
Priorat Natural	25x70	R27D	271
Priorat Natural Antislip	60x60	P64E	268
Priorat Natural Antislip	30x60	P34E	268
Queens Perla	24x69	R69E	67
Remake Blanco	60x60	P64C	276
Remake Blanco	30x60	P34C	276
Remake Blanco	25x70	R27C	281
Remake Concept Blanco	25x70	R27G	281
Remake Concept Crema	25x70	R27G	281
Remake Concept Gris	25x70	R27G	281
Remake Concept Visón	25x70	R27G	281
Remake Crema	60x60	P64C	277

Q

R

Item Artículo	Size Formato	Group Grupo	Page Página
Remake Crema	30x60	P34C	277
Remake Crema	25x70	R27C	281
Remake Gris	60x60	P64C	276
Remake Gris	30x60	P34C	276
Remake Gris	25x70	R27C	281
Remake Visón	60x60	P64C	277
Remake Visón	30x60	P34C	277
Remake Visón	25x70	R27C	281
Remake 30 Blanco	60x60	P64E	276
Remake 30 Crema	60x60	P64E	277
Remake 30 Gris	60x60	P64E	276
Remake 30 Gris Antislip	60x60	P64E	276
Remake 30 Visón	60x60	P64E	277
Remake 30 Visón Antislip	60x60	P64E	277
Remake 20 Multicolor	60x60	P64E	277
Remake 20 Multicolor Gris	60x60	P64E	276
Savia Blanco	150x24,8	P524D	286
Savia Blanco	18,5x75	P18D	287
Savia Blanco Antislip	150x24,8	P524E	286
Savia Blanco Antislip	18,5x75	P18E	287
Savia Century	150x24,8	P524D	286
Savia Century	18,5x75	P18D	287
Savia Crema	150x24,8	P524D	286
Savia Crema	18,5x75	P18D	287
Savia Gris	150x24,8	P524D	286
Savia Gris	18,5x75	P18D	287
Savia Roble	150x24,8	P524D	286
Savia Roble	18,5x75	P18D	287
Savia Roble Antislip	150x24,8	P524E	286
Savia Roble Antislip	18,5x75	P18E	287
Soho Arena	50x50	P50C	288
Soho Arena	25x70	R27C	289
Soho Blanco	25x70	R27C	289
Soho Crema	25x70	R27C	289
Soho Gris	50x50	P50C	288
Soho Gris	25x70	R27C	289
StoneTech Black	75x75	P75D	291

S

Item Artículo	Size Formato	Group Grupo	Page Página
Stonetech Black	60x60	P64D	291
Stonetech Black	30x60	P34D	291
Stonetech Black Soft	75x75	P75F	291
Stonetech Black 20 Mm	75x75	P75G	291
Stonetech Black 20 Mm	60x60	P64G	291
Stonetech Grafito	60x60	P64D	291
Stonetech Grafito	30x60	P34D	291
Stonetech Grafito 20 Mm	75x75	P75G	291
Stonetech Grafito 20 Mm	60x60	P64G	291

T

Termae Beige	50x50	P50C	292
Termae Beige	33x33	P33C	292
Termae Beige	25x50	R25D	293
Termae Concept Beige	25x50	R25G	293
Termae Concept Grey	25x50	R25G	293
Termae Concept White	25x50	R25G	293
Termae Grey	50x50	P50C	292
Termae Grey	33x33	P33C	292
Termae Grey	25x50	R25D	293
Termae White	50x50	P50C	292
Termae White	33x33	P33C	292
Termae White	25x50	R25D	293
Tetris Brancato Beige Honed	26x26	Y500	71
Tetris Brancato Blanco Honed	26x26	Y500	70
Tetris Brancato Gris Honed	26x26	Y500	70
Thai Blanco	25x70	R27C	295
Thai Negro	25x70	R27D	295

U

Uptown Art Beige	30x90	R90G	319, 321
Uptown Art Grey	30x90	R90G	318, 321
Uptown Art White	30x90	R90G	318, 321
Uptown Beige	150x75	P575D	304
Uptown Beige	150x37	P537D	304, 313
Uptown Beige	75x75	P75C	305
Uptown Beige	60x60	P64C	305

Item Artículo	Size Formato	Group Grupo	Page Página
Uptown Beige	50x50	P50C	323
Uptown Beige	37x75	P37C	305
Uptown Beige	30x90	R90D	319, 321
Uptown Beige	25x50	R25C	323
Uptown Beige Antislip	75x75	P75E	305
Uptown Beige Antislip	37x75	P37E	305
Uptown Beige 20 Mm	75x75	P75G	305
Uptown Beige 20 Mm	60x60	P64G	305
Uptown Black	75x75	P75D	306
Uptown Black	60x60	P64D	306
Uptown Black	37x75	P37D	306
Uptown Concept Beige	150x37	P537G	313
Uptown Concept Beige	30x90	R90G	319
Uptown Concept Beige	25x50	R25G	323
Uptown Concept Grey	150x37	P537G	312
Uptown Concept Grey	30x90	R90G	318
Uptown Concept Grey	25x50	R25G	323
Uptown Concept White	150x37	P537G	312
Uptown Concept White	30x90	R90G	318
Uptown Concept White	25x50	R25G	323
Uptown Grey	150x75	P575D	302
Uptown Grey	150x37	P537D	302, 312
Uptown Grey	75x75	P75D	303
Uptown Grey	60x60	P64D	303
Uptown Grey	50x50	P50C	323
Uptown Grey	37x75	P37D	303
Uptown Grey	25x50	R25C	323
Uptown Grey Antislip	75x75	P75E	303
Uptown Grey Antislip	37x75	P37E	303
Uptown Grey 20 Mm	75x75	P75G	303
Uptown Grey 20 Mm	60x60	P64G	303
Uptown Modul Beige	75x75	P75E	305
Uptown Modul Black	75x75	P75E	306
Uptown Modul Grey	75x75	P75E	303
Uptown Modul White	75x75	P75E	301
Uptown White	150x75	P575D	300
Uptown White	150x37	P537D	300, 312
Uptown White	75x75	P75C	301
Uptown White	60x60	P64C	301
Uptown White	50x50	P50C	323
Uptown White	37x75	P37C	301

Item Artículo	Size Formato	Group Grupo	Page Página
Uptown White	30x90	R90D	318, 321
Uptown White	25x50	R25C	323
Uptown White Antislip	75x75	P75E	301
Uptown White Antislip	37x75	P37E	301
Uptown White 20 Mm	75x75	P75G	301
Uptown White 20 Mm	60x60	P64G	301
Urban Beige	100x50	P100C	325
Urban Beige	60x60	P64C	325
Urban Beige	30x60	P34C	325
Urban Grafito	60x60	P64C	326
Urban Grafito	30x60	P34C	326
Urban Grafito Antislip	60x60	P64E	326
Urban Grafito Antislip	30x60	P34E	326
Urban Gris	100x50	P100C	326
Urban Gris	60x60	P64C	326
Urban Gris	30x60	P34C	326
Urban Gris Antislip	60x60	P64E	326
Urban Gris Antislip	30x60	P34E	326
Urban Moka	100x50	P100D	325
Urban Negro	100x50	P100D	327
Urban Negro	60x60	P64D	327
Urban Negro	30x60	P34D	327
Urban Negro Antislip	60x60	P64E	327
Urban Negro Antislip	30x60	P34E	327

V

Velvet Blanco	30x90	R90D	329
Velvet Crema	30x90	R90D	329
Velvet Grafito	30x90	R90E	329
Velvet Marrón	30x90	R90E	329
Velvet Modul Blanco	30x90	R90E	329
Velvet Modul Crema	30x90	R90E	329
Village Cement	100x24,8	P125D	333
Village Cement	18,5x75	P18D	333
Village Cream	100x24,8	P125D	333
Village Cream	18,5x75	P18D	333
Village Dark	100x24,8	P125D	333
Village Dark	18,5x75	P18D	333
Village Oak	100x24,8	P125D	333

W

Village Oak	18,5x75	P18D	333
Village White	100x24,8	P125D	333
Village White	18,5x75	P18D	333
Wall Brick Black	30x90	R90G	335
Wall Brick Old Cotto	30x90	R90G	335
Wall Brick Old Cream	30x90	R90G	335
Wall Brick Old Grey	30x90	R90G	335
Wall Brick Old Smoke	30x90	R90G	335
Wall Brick White	30x90	R90G	335

Z

Zebra Blanco	100x50	P100C	337
Zócalo Boboli White	12x30	S520	225
Zócalo Piaget Gold	12,5x30	S570	143, 321
Zócalo Piaget Silver	12,5x30	S570	142, 321
Zócalo Sasha	12,5x30	S570	179
Zócalo Toussete Beige	12,5x30	S570	321
Zócalo Toussete Grey	12,5x30	S570	321
Zócalo Toussete White	12,5x30	S570	321

COLLECTIONS



100x50 | 60x60 | 30x60
40" x20" | 24" x24" | 12" x24"

ALPINO

FULL BODY FLOOR TILES | PORCELÁNICO TODO MASA
PLEINE MASSE | BODENFLIESEN EINE MASSE

Natural: Clase I | R9



Alpino Negro
100x50 cm

P100D
GEQ2100K



Alpino Negro
30x60 cm

P34D
GEQ0500K

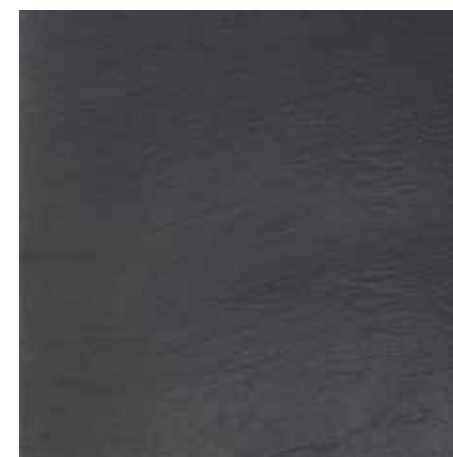

Alpino Negro
60x60 cm

P64D
GEQ4200K

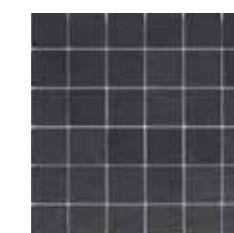

Mosaico Alpino Negro
30x30 cm Y500 GEQ0400K



Rounded edge skirting 8x60 | Rodapié romano 8x60 S280
Negro GEQRQ00K



Step 30x60 | Peldaño simple 30x60 S500
Negro GEQ0502K
Step 100x50 | Peldaño simple 100x50 S600
Negro GEQ2101K



Double Step 30x60 | Peldaño doble 30x60 S650
Negro GEQ0501K
Double Step 100x50 | Peldaño doble 100x50 S720
Negro GEQ2102K

PACKING LIST

formato/size	artículo/item	pzs-cj/pcs-box	m²cj/box	kg/cj/box	cj/box/epl	m²/epl	kg/epl
100x50/40" x20"	Base	2	1,00	23,60	28	28,00	683,80
60x60/24" x24"	Base	3	1,08	22,53	40	43,20	924,20
30x60/12" x24"	Base	6	1,08	22,32	40	43,20	915,80
30x30/12" x12"	Mosaico	11	1,00	20,46	36	36,00	759,56
8x60/3" x24"	Rodapié	10	0,48	11,50	80	38,40	943,00
30x60/12" x24"	Peldaño	6	1,08	20,58	Please ask for information / Consulte información		
30x60/12" x24"	Peldaño Doble	2	0,36	13,28	Please ask for information / Consulte información		
100x50/40" x20"	Peldaño	2	1,00	25,20	Please ask for information / Consulte información		
100x50/40" x20"	Peldaño Doble	2	1,00	28,34	Please ask for information / Consulte información		



60x60
24" x 24"

ARABESCATTO

GLAZED PORCELAIN FLOOR TILES

PAVIMENTO PORCELÁNICO ESMALTADO

GRÈS CÉRAME EMAILÉ

GLASIERTE FEINSTEINZEUG BODENFLIESEN



Arabescatto Blanco
60x60 cm

P64C
G2942000 12

PACKING LIST

formato/size	artículo/item	pzs-cj/pcs-box	m ² cj/box	kg/cj/box	cj/box/epl	m ² /epl	kg/epl
60x60/24"x24"	Base	3	1,08	22,53	40	43,20	924,20



100x24,8
40" x 10" **ARDENNES**

COLOURED BODY PORCELAIN FLOOR TILES | PAVIMENTO PORCELÁNICO COLOREADO
GRÉS CÉRAME COLOREÉ | DURCHGEFÄRBTE FEINSTEINZEUGBODENFLIESEN

Natural: Clase I | R9
Antislip: Clase 3 | R11 | A+B+C



Ardennes Blanco
100x24,8 cm P125D GJL44000 34



Ardennes Crema
100x24,8 cm P125D GJL44001 34



Ardennes Roble
100x24,8 cm P125D GJL44011 34

Ardennes Roble Antislip Clase3/R11/A+B+C P125E GJL44061 34



Ardennes Tortora
100x24,8 cm P125D GJL4400T 34

Ardennes Tortora Antislip Clase3/R11/A+B+C P125E GJL4403T 34



Ardennes Castaño
100x24,8 cm P125D GJL4400C 34



Ardennes Century
100x24,8 cm P125D GJL4401C 34

Rounded edge skirting 8x50 | Rodapié romo 8x50 S150

Blanco	GJLVP000	Tortora	GJLVP00T
Crema	GJLVP001	Castaña	GJLVP00C
Roble	GJLVP011	Century	GJLVP01C

Step 100x24,8 | Peldaño simple 100x24,8 S600

Blanco	GJL44010	Tortora	GJL4401T
Crema	GJL44021	Castaña	GJL4402C
Roble	GJL44031	Century	GJL4403C

Step 100x24,8 Antislip | Peldaño simple 100x24,8 Antislip S600

Roble	GJL44081	Tortora	GJL4404T
-------	----------	---------	----------

Double Step 100x24,8 | Peldaño doble 100x24,8 S720

Blanco	GJL44020	Tortora	GJL4402T
Crema	GJL44041	Castaña	GJL4404C
Roble	GJL44051	Century	GJL4405C

Double Step 100x24,8 Antislip | Peldaño doble 100x24,8 Antislip S720

Roble	GJL44091	Tortora	GJL4405T
-------	----------	---------	----------

PACKING LIST

formato/size	artículo/item	pzs-cj/pcs-box	m²/cj/box	kg/cj/box	cj/box/epl	m²/epl	kg/epl
100x24,8/40" x 10"	Base/ Antislip	3	0,74	17,67	40	29,60	729,80
8x50/3" x 20"	Rodapié	10	0,40	9,60	120	48	1175
100x24,8/40" x 10"	Peldaño Base / Antislip	3	0,74	22,50	Please ask for information / Consulte información		
100x24,8/40" x 10"	Peldaño Doble Base / Antislip	2	0,50	12,60	Please ask for information / Consulte información		

WALL TILES | ARDENNES CASTAÑO 100X24,8
FLOOR TILES | ARDENNES CASTAÑO 100X24,8



WALL TILES | ATELIER BLANCO 25X70, LISTELO SARGA NEGRO 4,6X70,
DECOR SARGA NEGRO 25X25
FLOOR TILES | MATCH NEGRO 50X50



25x70
10" x 28" **ATELIER**

WHITE BODY WALL TILES | REVESTIMIENTO PASTA BLANCA | FAÏENCE PÂTE BLANCHE | WEISSSCHERBIGE WANDFLIESEN



Atelier Blanco R27C
25x70 cm KZAZA000



Atelier Beige R27C
25x70 cm KZAZA001



Listelo Sarga Negro S420
4,6x70 cm KZA2700K



Listelo Sarga Marrón S420
4,6x70 cm KZA27003

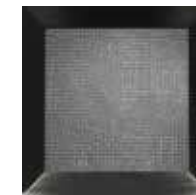

** Decor Sarga Negro
25x25 cm S470 KZA2900K



** Decor Sarga Marrón
25x25 cm S470 KZA29003

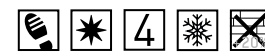

50X50
20" X20" **MATCH**

GLAZED PORCELAIN FLOOR TILES | PAVIMENTO PORCELÁNICO ESMALTADO | GRÈS CÉRAME ÉMAILLÉ | GLASIERTE FEINSTEINZEUG BODENFLIESEN



Match Negro P50D
50x50 GQ41301K

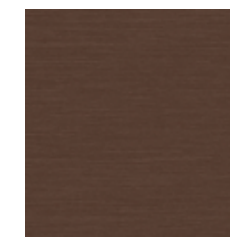

Match Marrón P50D
50x50 GQ413023



Rounded edge skirting 8x50 | Rodapié romano 8x50 S150
Negro GQ4VP01K Marrón GQ4VP013

PACKING LIST

formato/size	artículo/item	pzs-cj/pcs-box	m²/cj/box	kg/cj/box	cj/box/epl	m²/epl	kg/epl
25x70/10" x 28"	Base	7	1,23	21,35	42	51,66	919,70
25x25/10" x 10"	Decor	4	0,25	5,48	66	16,50	384,68
4,6x70/1,8" x 28"	Listelo	4	0,13	2,52	144	18,55	385,88
50x50/20" x 20"	Base	4	1,00	20,52	36	36,00	761,72
8x50/3" x 20"	Rodapié	10	0,40	9,60	120	48	1175

** En el caso de colocar el decorado de forma aleatoria, se recomienda cortar la base a 25x45, conservando así la continuidad de las juntas/ In case of fixing the 25cm Decor in a random manner, we recommend to cut the plain tile to size 25x45cm to avoid the brick effect with the 25x70cm plain tile



100x50 | 60x60 | 30x60
 40" x 20" | 24" x 24" | 12" x 24"

BEAUVAL

COLOURED BODY PORCELAIN FLOOR TILES | PAVIMENTO PORCELÁNICO COLOREADO
 GRÉS CÉRAME COLORE | DURCHGEFÄRBTE FEINSTEINZEUGBODENFLIESEN

Natural: Class I | R9
 Antislip: Class 3 | R11 | A+B+C



Beauval Blanco
 100x50 cm

P100D
 GED21000 12



Beauval Blanco
 30x60 cm
 Beauval Blanco Lappato
 30x60 cm
 Beauval Blanco Antislip
Class3/R11/A+B+C
 30x60 cm

P34D 36
 GED05000
 P34F 36
 GED05020
 P34E 36
 GED05040



Muro Beauval Blanco
 30x64 cm

Y500
 GEDMR000



Mosaico Beauval Blanco
 30x30 cm Y600 GED04000



Beauval Blanco
 60x60 cm
 Beauval Blanco Lappato
 60x60 cm
 Beauval Blanco Antislip
Class3/R11/A+B+C
 60x60 cm

P64D 18
 GED42000
 P64F 18
 GED42010
 P64E 18
 GED42020



Beauval Almond
100x50 cm

P100D
GED21020 12



Beauval Almond
30x60 cm

P34D
GED05010 36

Beauval Almond Lappato
30x60 cm

P34F
GED05030 34

Beauval Almond Antislip
30x60 cm

P34E
GED05050 36

Clase3/R11/A+B+C



Beauval Crema
100x50 cm

P100D
GED21001 12



Beauval Crema
30x60 cm

P34D
GED05251 34

Beauval Crema Lappato
30x60 cm

P34F
GED05301 36

Beauval Crema Antislip
30x60 cm

P34E
GED05221 36

Clase3/R11/A+B+C



Muro Beauval Almond
30x64 cm

Y500
GEDMR010



Beauval Almond
60x60 cm

P64D
GED42011 18

Beauval Almond Lappato
60x60 cm

P64F
GED42031 17

Beauval Almond Antislip
60x60 cm

P64E
GED42051 18

Clase3/R11/A+B+C



Muro Beauval Crema
30x64 cm

Y500
GEDMR101



Mosaico Beauval Almond
30x30 cm Y600 GED04010



Mosaico Beauval Crema
30x30 cm Y600 GED04101



Beauval Crema
60x60 cm

P64D
GED42001 18

Beauval Crema Lappato
60x60 cm

P64F
GED42021 18

Beauval Crema Antislip
60x60 cm

P64E
GED42041 18

Clase3/R11/A+B+C

Rounded edge skirting 8x60 Rodapié romo 8x60				S280
Blanco	GEDRQ000	Almond	GEDRQ001	
Crema	GEDRQ461			
Rounded edge skirting 8x60 Lappato Rodapié romo 8x60 Lappato				S320
Blanco	GEDRQ010	Almond	GEDRQ011	
Crema	GEDRQ441			

Step 30x60 Peldaño simple 30x60				S500
Blanco	GED05060	Almond	GED05001	
Crema	GED05371			
Step 30x60 Lappato Peldaño simple 30x60 Lappato				S520
Blanco	GED05070	Almond	GED05011	
Crema	GED05311			
Step 30x60 Antislip Peldaño simple 30x60 Antislip				S500
Blanco	GED05080	Almond	GED05021	
Crema	GED05261			
Step 100x50 Peldaño simple 100x50				S600
Blanco	GED21040	Almond	GED21021	
Crema	GED21031	S600		

Double Step 30x60 Peldaño doble 30x60				S650
Blanco	GED05090	Almond	GED05031	
Crema	GED05271			
Double Step 30x60 Lappato Peldaño doble 30x60 Lappato				S670
Blanco	GED05100	Almond	GED05041	
Crema	GED05281			
Double Step 30x60 Antislip Peldaño doble 30x60 Antislip				S650
Blanco	GED05110	Almond	GED05051	
Crema	GED05291			
Double Step 100x50 Peldaño doble 100x50				S720
Blanco	GED21060	Almond	GED21061	
Crema	GED21071			

PACKING LIST

formato/size	artículo/item	pzs-cj/pcs-box	m²/cj/box	kg/cj/box	cj/box/epl	m²/epl	kg/epl
100x50/40"x20"	Base	2	1,00	23,60	28	28,00	683,80
60x60/24"x24"	Base/ Lappato / Antislip	3	1,08	22,53	40	43,20	924,20
30x60/12"x24"	Base/ Lappato / Antislip	6	1,08	22,32	40	43,20	915,80
30x64/12"x25"	Muro	5	0,96	18,45	30	28,80	576,50
30x30/12"x12"	Mosaico	11	1,00	20,46	36	36,00	759,56
8x60/3"x24"	Rodapié Base / Lappato	10	0,48	11,30	80	38,40	943,00
30x60/12"x24"	Peldaño Base / Lappato / Antislip	6	1,08	20,58	Please ask for information / Consulte información		
30x60/12"x24"	Peldaño Doble Base / Lappato / Antislip	2	0,36	13,28	Please ask for information / Consulte información		
100x50/40"x20"	Peldaño	2	1,00	25,20	Please ask for information / Consulte información		
100x50/40"x20"	Peldaño Doble	2	1,00	28,34	Please ask for information / Consulte información		



25x70
10" x 28" **BEAUVAL**

WHITE BODY WALL TILES

REVESTIMIENTO PASTA BLANCA

FAIÈNCE PÂTE BLANCHE

WEISSSCHERBIGE WANDFLIESEN



Beauval Blanco
25x70 cm

R27C
KEDZA000 15



Beauval Crema
25x70 cm

R27C
KEDZA001 15



Beauval Concept Blanco
25x70 cm

R27G
KEDZA010 15



Beauval Concept Crema
25x70 cm

R27G
KEDZA011 15



Muro Beauval Blanco
30x64 cm

Y500
GEDMR000



Muro Beauval Crema
30x64 cm

Y500
GEDMR101



Mosaico Beauval Blanco
30x30 cm
Y600 GED04000



Listelo Amiens Blanco
5x36 cm
S390 KED0E010



Mosaico Beauval Crema
30x30 cm
Y600 GED04101



Listelo Amiens Crema
5x36 cm
S390 KED0E011

PACKING LIST

formato/size	artículo/item	pzs-cj/pcs-box	m²/cj/box	kg/cj/box	cj/box/epl	m²/epl	kg/epl
25x70/10" x 28"	Base / Concept	7	1,23	21,35	42	51,66	919,70
30x64/11,8" x 25"	Muro	5	0,96	18,45	30	28,80	576,50
30x30/12" x 12"	Mosaico	11	1,00	20,46	36	36,00	759,56
5x36/2" x 14"	Listelo	10	0,18	3,60	72	12,96	282,20



25x50
10" x 20" **BETON**

WHITE BODY WALL TILES

REVESTIMIENTO PASTA BLANCA

FAÏENCE PÂTE BLANCHE

WEISSSCHERBIGE WANDFLIESEN

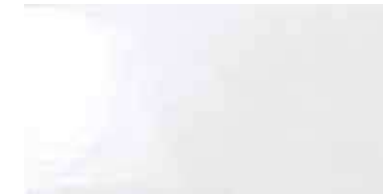

Beton Blanco R25C
25x50 cm K39TP012



Beton Beige R25C
25x50 cm K39TP001



Beton Gris R25C
25x50 cm K39TP002



Beton Moka R25C
25x50 cm K39TP003

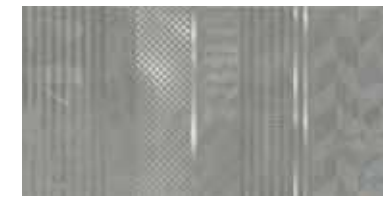

**** Decor Graffiti Gris (Set 2)** S540
25x50 cm K39TP032



**** Decor Graffiti Moka (Set 2)** S540
25x50 cm K39TP01D



Listelo Graffiti Gris S270
3,8x50 cm K39ZT002



Listelo Graffiti Moka S270
3,8x50 cm K39ZT00D

PACKING LIST

formato/size	artículo/item	pzs.-cj/pcs.-box	m ² /cj/box	kg/cj/box	cj/box/epl	m ² /epl	kg/epl
25x50/10"x20"	Base	11	1,38	21,78	36	49,68	807,08
25x50/10"x20"	Decor	8	1,00	16,00	45	45,00	743
3,8x50/1,5"x20"	Listelo	22	0,42	7,48	90	37,62	696,20

** Precio por pieza / Price per piece

WALL TILES | BETON BLANCO 25X50, LISTELO GRAFFITI GRIS 3,8X50
FLOOR TILES | PETIT GRANIT GRIS NATURAL 60X60



WALL TILES | ART BLANCO 25X50

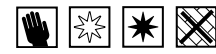

25x70 | 25x50 | 24x69
10" x 28" | 10" x 20" | 9" x 27" **BLANCOS**

WHITE BODY WALL TILES

REVESTIMIENTO PASTA BLANCA

FAIENCE PÂTE BLANCHE

WEISSSCHERBIGE WANDFLIESEN

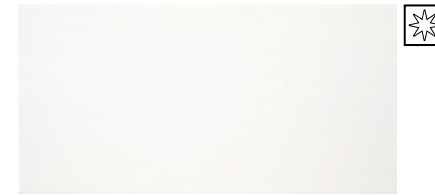

Art Blanco R25C
25x50 cm KRT19000

Perfil Acero Plata S260
1,5x50 cm KJQBH00L



Fox Blanco R25C
25x50 cm KFX19000

Perfil Acero Plata S260
1,5x50 cm KJQBH00L



Queens Perla R69E
24x69 cm KBLAG002



Atlas Blanco R69C
24x69 cm KAAAG000



Geo Blanco R27C
25x70 cm KGJZA000

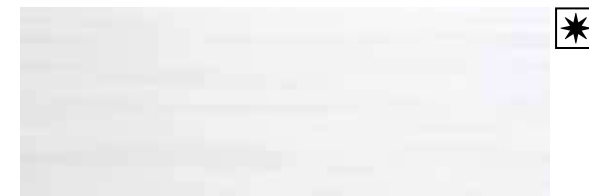

Nova Blanco R27C
25x70 cm K7TZA000

Perfil Acero Plata S300
1,5x70 cm KZD2800L

Perfil Acero Plata S300
1,5x70 cm KZD2800L

PACKING LIST

formato/size	artículo/item	pzs-cj/pcs-box	m²cj/box	kg/cj/box	cj/box/epl	m²/epl	kg/epl
25x70/10" x 28"	Base	7	1,23	21,35	42	51,66	919,70
24x69/9" x 27"	Base	7	1,16	19,53	42	48,72	843,00
25x50/10" x 20"	Base	11	1,38	21,78	36	49,68	807,08
1,5x50/0,8" x 20"	Perfil	6	0,05	0,48	400	18,00	215,00
1,5x70/0,8" x 28"	Perfil	6	0,06	0,72	400	25,20	311,00

BRANCATO

HONED



FLOOR TILE | BRANCATO GRIS HONED 73X73

BRANCATO HONED

73x73 | 36x73 | 18x73
28" x 28" | 14" x 28" | 7" x 28"



COLOURED BODY PORCELAIN FLOOR TILES | PAVIMENTO PORCELÁNICO COLOREADO | GRÉS CÉRAME COLORE | DURCHGEFÄRBTE FEINSTEINZEUGBODENFLIESEN



Brancato Blanco Honed
73x73 cm

P75H
GEE5N000 15



Brancato Gris Honed
73x73 cm

P75H
GEE5N002 15



Brancato Beige Honed
73x73 cm

P75H
GEE5N001 15



Brancato Blanco Honed
36x73 cm

P37H
GEE5P000 30



Brancato Gris Honed
36x73 cm

P37H
GEE5P002 30



Brancato Beige Honed
36x73 cm

P37H
GEE5P001 30



Brancato Blanco Honed
18x73 cm

P18H
GEE5Q000 42

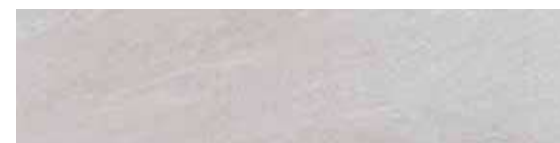

Brancato Gris Honed
18x73 cm

P18H
GEE5Q002 42



Brancato Beige Honed
18x73 cm

P18H
GEE5Q001 42



Tetris Brancato Blanco Honed
26x26 cm Y500 GEEZZ000

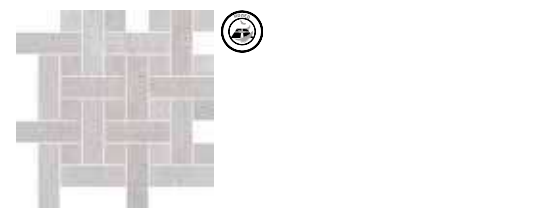

Tetris Brancato Gris Honed
26x26 cm Y500 GEEZZ002



Tetris Brancato Beige Honed
26x26 cm Y500 GEEZZ001

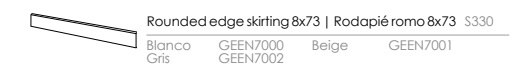

Rounded edge skirting 8x73 | Rodapié romano 8x73 S330
Blanco Gris GEEN7000 GEEN7002 Beige GEEN7001

PACKING LIST

formato/size	artículo/item	pzs-cj/pcs-box	m ² cj/box	kg/cj/box	cj/box/epl	m ² /epI	kg/epI
73x73/28" x 28"	Base	2	1,07	23,96	42	44,94	1.029,32
36x73/14" x 28"	Base	4	1,07	23,60	48	51,36	1.155,80
18x73/7" x 28"	Base	9	1,19	25,20	48	57,12	1.232,60
26x26/10" x 10"	Tetris	11	0,74	15,40	36	26,64	577,40
8x73/3" x 28"	Rodapié	10	0,60	12,90	80	48,00	1055,00

BRANCATO



Natural: Clase 1 | R9 | A
 Antislip: Clase 3 | R11 | A+B+C
 2Ø MM: 3 | R11 | A+B+C



Brancato Blanco
 100x50 cm P100D GEE21010 14



Brancato Blanco P64D GEE42000 19
 60x60 cm
Brancato Blanco Lappato P64F GEE42010 19
 60x60 cm
Brancato Blanco Antislip P64E GEE42020 19
Clase3/R11/A+B+C
 60x60 cm



Brancato Beige
 100x50 cm P100D GEE21011 14



Brancato Beige P64D GEE42001 17
 60x60 cm
Brancato Beige Lappato P64F GEE42011 17
 60x60 cm
Brancato Beige Antislip P64E GEE42021 17
Clase3/R11/A+B+C
 60x60 cm
Brancato Beige 2ØMM P64G GEE42051 12
Clase3/R11/A+B+C
 60x60 cm



Brancato Blanco P75D GEE0R000 14
 75x75 cm
Brancato Blanco Antislip Clase3/R11/A+B+C P75E GEE0R010 14
 75x75 cm



Brancato Blanco P34D GEE05160 38
 30x60 cm
Brancato Blanco Lappato P34F GEE05170 38
 30x60 cm
Brancato Blanco Antislip P34E GEE05200 38
Clase3/R11/A+B+C
 30x60 cm



Brancato Beige P75D GEE0R011 14
 75x75 cm
Brancato Beige Antislip Clase3/R11/A+B+C P75E GEE0R031 14
 75x75 cm
Brancato Beige 2ØMM Clase3/R11/A+B+C P75G GEE0R001 15
 75x75 cm



Brancato Beige P34D GEE05341 34
 30x60 cm
Brancato Beige Lappato P34F GEE05321 34
 30x60 cm
Brancato Beige Antislip P34E GEE05331 34
Clase3/R11/A+B+C
 30x60 cm



Brancato Blanco P37D GEEAC000 28
 37x75 cm
Brancato Blanco Antislip Clase3/R11/A+B+C P37E GEEAC030 28
 3 75 cm

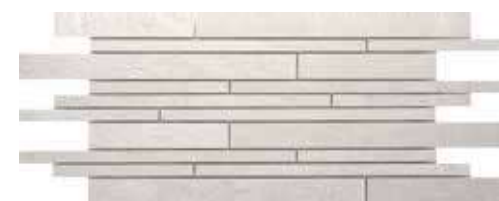

Muro Brancato Blanco Y500 GEEMR100
 30x64 cm



Brancato Beige P37D GEEAC001 28
 37x75 cm
Brancato Beige Antislip Clase3/R11/A+B+C P37E GEEAC031 28
 37x75 cm



Muro Brancato Beige Y500 GEEMR101
 30x64 cm

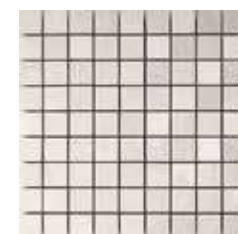

Mosaico Brancato Blanco Y600 GEE04100
 30x30 cm



Mosaico Brancato Beige Y600 GEE04101
 30x30 cm

BRANCATO 75x75 | 37x75 | 60x60 | 30x60

30"x30" | 15"x30" | 24"x24" | 12"x24"

COLOURED BODY PORCELAIN FLOOR TILES | PAVIMENTO PORCELÁNICO COLOREADO
GRES CERAME COLORE | DURCHGEFÄRBTE FEINSTEINZEUGBODENFLIESEN



Natural: Clase I | R9 | A
Antislip: Clase 3 | R11 | A+B+C
2Ø MM: 3 | R11 | A+B+C



Brancato Gris 75x75 cm P75D GEE0R002 14
Brancato Gris Antislip 75x75 cm Clase3/R11/A+B+C P75E GEE0R012 14



Brancato Gris 60x60 cm P64D GEE42002 19



Brancato Gris 37x75 cm P37D GEEAC002 28
Brancato Gris Antislip 37x75 cm Clase3/R11/A+B+C P37E GEEAC032 28



Brancato Gris 30x60 cm P34D GEE05002 38

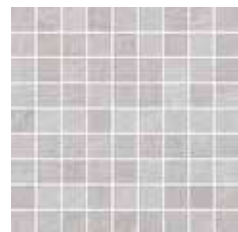

Mosaico Brancato Gris 30x30 cm Y600 GEE04002



Muro Brancato Gris 30x64 cm Y500 GEEMR002



FLOOR TILE | BRANCATO GRIS 75X75

Profile	Color	Article	Price
Rounded edge skirting 8x60 Rodapié romano 8x60	Blanco	GEERQ340	\$280
	Beige	GEERQ301	
Rounded edge skirting 8x60 Lappato Rodapié romano 8x60 Lappato	Blanco	GEERQ230	\$320
	Beige	GEERQ361	
Rounded edge skirting 8x75 Rodapié romano 8x75	Blanco	GEE3E000	\$290
	Gris	GEE3E002	
Step 30x60 Peldaño simple 30x60	Blanco	GEE05150	\$500
	Gris	GEE05022	
Step 30x60 Lappato Peldaño simple 30x60 Lappato	Blanco	GEE05240	\$520
	Beige	GEE05231	
Step 30x60 Antislip Peldaño simple 30x60 Antislip	Blanco	GEE05140	\$500
	Beige	GEE05211	
Step 37x75 Peldaño simple 37x75	Blanco	GEEAC010	\$560
	Gris	GEEAC012	
Step 37x75 Antislip Peldaño simple 37x75 Antislip	Blanco	GEEAC040	\$560
	Gris	GEEAC042	
Step 100x50 Peldaño simple 100x50	Blanco	GEE21020	\$600
	Beige	GEE21021	
Double Step 30x60 Peldaño doble 30x60	Blanco	GEE05130	\$650
	Gris	GEE05012	
Double Step 30x60 Lappato Peldaño doble 30x60 Lappato	Blanco	GEE05120	\$670
	Beige	GEE05351	
Double Step 30x60 Antislip Peldaño doble 30x60 Antislip	Blanco	GEE05110	\$650
	Beige	GEE05181	
Double Step 37x75 Peldaño doble 37x75	Blanco	GEEAC020	\$690
	Beige	GEEAC021	
Double Step 37x75 Antislip Peldaño doble 37x75 Antislip	Blanco	GEEAC050	\$690
	Gris	GEEAC052	
Double Step 100x50 Peldaño doble 100x50	Blanco	GEE21040	\$720
	Beige	GEE21041	

PACKING LIST

formato/size	artículo/item	pcs-cj/pcs-box	m²cj/box	kg/cj/box	cj/box/epl	m²/epl	kg/epl
100x50/40"x20"	Base / Lappato	2	1,00	23,60	28	28,00	683,80
75x75/30"x30"	Base / Antislip	2	1,13	24,62	42	47,46	1057,04
75x75/30"x30"	20 MM	1	0,56	24,91	42	23,52	1069,22
60x60/24"x24"	Base / Lappato / Antislip	3	1,08	22,53	40	43,20	924,20
60x60/24"x24"	20 MM	2	0,72	31,72	32	23,04	1038,04
30x60/12"x24"	Base / Lappato / Antislip	6	1,08	22,32	40	43,20	915,80
37x75/15"x30"	Base / Antislip	4	1,13	24,24	48	54,24	1186,52
30x64/11,8"x25"	Muro	5	0,96	18,45	30	28,80	576,50
30x30/12"x12"	Mosaico	11	1,00	20,46	36	36,00	759,56
8x60/3"x24"	Rodapié Base / Lappato	10	0,48	11,30	80	38,40	943,00
8x75/3"x30"	Rodapié	10	0,60	12,90	80	48,00	1055,00
30x60/12"x24"	Peldaño Base / Lappato / Antislip	6	1,08	20,58			Please ask for information / Consulte información
37x75/15"x30"	Peldaño Base / Antislip	4	1,11	24,24			Please ask for information / Consulte información
100x50/40"x20"	Peldaño	2	1,00	25,20			Please ask for information / Consulte información
30x60/12"x24"	Peldaño Doble Base / Lappato / Antislip	2	0,36	13,28			Please ask for information / Consulte información
37x75/15"x30"	Peldaño Doble Base / Antislip	2	0,56	12,12			Please ask for information / Consulte información
100x50/40"x20"	Peldaño Doble	2	1,00	28,34			Please ask for information / Consulte información



WALL TILE | BRANCATO BEIGE 30X60, BRANCATO CONCEPT BEIGE 30X60
 FLOOR TILE | BRANCATO BEIGE 60X60



30x90 | 30x60
 12" x 36" | 12" x 24" **BRANCATO**

WHITE BODY WALL TILES | REVESTIMIENTO PASTA BLANCA | FAÏENCE PÂTE BLANCHE | WEISSSCHERBIGE WANDFLIESEN



Brancato Blanco
 30x90 cm R90D
 KEEP000 12



Brancato Concept Grafito
 30x90 cm R90F
 KEEP00J 3



Perfil Acero Plata
 1,5x90 cm S330
 K432L00L



Brancato Beige
 30x90 cm R90D
 KEEP001 12



Brancato Concept Marrón
 30x90 cm R90F
 KEEP003 3



Brancato Art Beige
 30x90 cm R90H
 KEEP021



Listelo Brancato Art Beige
 4,5x90 cm S490
 KEE3P001



Perfil Acero Bronce
 1,5x90 cm S330
 K432L00M

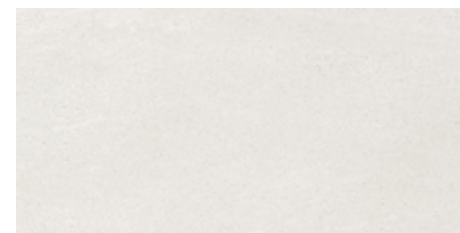

Brancato Blanco (PB)
 30x60 cm R36D
 KEE05000 12

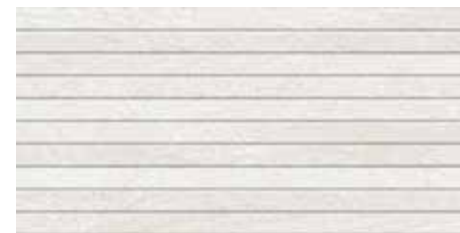

Brancato Concept Blanco
 30x60 cm R36G
 KJN05040 3



Perfil Acero Plata
 1,5x60 cm S270
 KEEN400A



Brancato Beige (PB)
 30x60 cm R36D
 KEE05001 12



Brancato Concept Beige
 30x60 cm R36G
 KJN05041 3

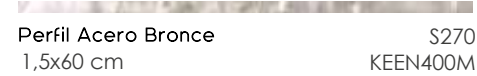

Perfil Acero Bronce
 1,5x60 cm S270
 KEEN400M

PACKING LIST

formato/size	artículo/item	pzs-cj/pcs-box	m ² cj/box	kg/cj/box	cj/box/epl	m ² /epI	kg/epI
30x90/12"x36"	Base / Concept / Art	4	1,08	18,84	51	55,08	983,84
30x60/12"x24"	Base / Concept	6	1,08	18,48	40	43,20	762,20
4,5x90/1,5"x20"	Listelo	6	0,24	4,50	56	13,61	275,00
1,5x90/1,8"x36"	Perfil	6	0,08	0,90	336	27,22	325,40
1,5x60/1,8"x24"	Perfil	6	0,05	0,54	500	27,00	293,00



WALL TILES | BRANCATO BLANCO 25X50, BRANCATO CONCEPT BLANCO 25X50, LISTELO BRANCATO BLANCO 4X50
FLOOR TILES | BRANCATO BLANCO 50X50



25x50 10"x20" BRANCATO

WHITE BODY WALL TILES

REVESTIMIENTO PASTA BLANCA

FAIENCE PÂTE BLANCHE

WEISSSCHERBIGE WANDFLIESEN



Brancato Blanco 25x50 cm R25C KEETP000 12



Brancato Beige 25x50 cm R25C KEETP001 12



Listelo Brancato Blanco 4x50 cm S340 KEEAV000



Listelo Brancato Beige 4x50 cm S340 KEEAV001



Brancato Concept Blanco 25x50 cm R25G KEETP010 2



Brancato Concept Beige 25x50 cm R25G KEETP011 2



50X50 20"x20" BRANCATO

GLAZED PORCELAIN FLOOR TILES

PAVIMENTO PORCELÁNICO ESMALTADO

GRÈS CÉRAME ÉMAILLE

GLASIERTE FEINSTEINZEUG BODENFLIESEN



Brancato Blanco 50x50 P50C GEE13000



Brancato Beige 50x50 P50C GEE13001

Rounded edge skirting 8x50 | Rodapié romano 8x50 S150
Blanco GEEVP000 Beige GEEVP001

PACKING LIST

formato/size	artículo/item	pzs-cj/pcs-box	m²cj/box	kg/cj/box	cj/box/epl	m²/epl	kg/epl
25x50/10"x20"	Base / Concept	11	1,38	21,78	36	49,68	807,08
50x50/20"x20"	Base	4	1,00	20,52	36	36,00	761,72
4x50/1,6"x20"	Listelo	22	0,44	6,82	84	36,96	596,88
8x50/3"x20"	Rodapié	10	0,40	9,60	120	48,00	1175,00



30x90
12" x36" **CHELSEA**

WHITE BODY WALL TILES | REVESTIMIENTO PASTA BLANCA | FAÏENCE PÂTE BLANCHE | WEISSSCHERBIGE WANDFLIESEN

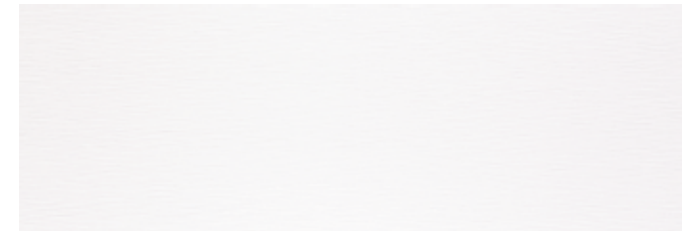

Chelsea Snow 30x90 cm R90C
KBJPG000

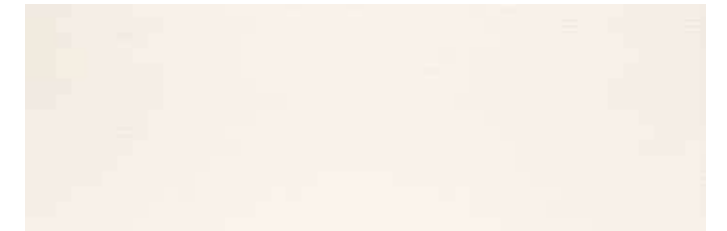

Chelsea Cream 30x90 cm R90C
KBJPG001



Decor Chelsea Snow 30x90 cm S690
KBJPG010



Decor Chelsea Cream 30x90 cm S690
KBJPG011



Listelo Chelsea Dark 6,9x90 cm S570
KBJ0000J



Listelo Chelsea Brown 6,9x90 cm S570
KBJ00003



Perfil Metallic 2x90 cm S290
KBLW3002

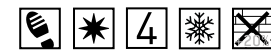

50X50
20" X20" **MATCH**

GLAZED PORCELAIN FLOOR TILES | PAVIMENTO PORCELÁNICO ESMALTADO | GRÈS CÉRAMÉ ÉMAILLÉ | GLASIERTE FEINSTEINZEUG BODENFLIESEN

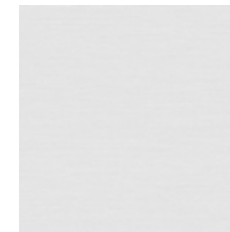

Match Snow P50D 50x50cm GQ413050



Match Gris P50D 50x50cm GQ413002

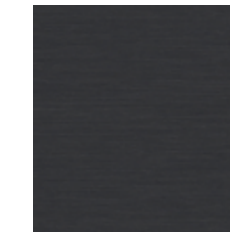

Match Negro P50D 50x50cm GQ41301K



Match Visón P50D 50x50cm GQ41300C



PACKING LIST

formato/size	artículo/item	pzs-cj/pcs-box	m²cj/box	kg/cj/box	cj/box/epl	m²/epl	kg/epl
30x90/12" x36"	Base	4	1,08	18,84	51	55,08	983,84
30x90/12" x36"	Decor	4	1,08	21,72	12	12,96	283,64
6,9x90/2,7" x35,4"	Listelo	6	0,37	7,50	54	20,12	428,00
2x90/0,8" x35,4"	Perfil Metallic	6	0,11	3,00	200	21,60	623,00
50x50/20" x20"	Base	4	1,00	20,52	36	36,00	761,72
8x50/3" x20"	Rodapié	10	0,40	9,60	120	48	1175

CHEVERNIE

WALL TILES | CHEVERNIE CREMA BRILLO 25X50, CHEVERNIE CREMA BRILLO 8X25,
LISTELO CHEVERNIE CREMA BRILLO 5,8X25
FLOOR TILES | CHEVERNIE CREMA MATE 50X50

CHEVERNIE

25x50 | 8x50
10" x 20" | 3" x 10"



WHITE BODY WALL TILES | REVESTIMIENTO PASTA BLANCA | FAÏENCE PÂTE BLANCHE | WEISSSCHERBIGE WANDFLIESEN

 
Bullnose Chevernie Perla Mate
5x25 cm S120 KQ3L5000

8



Chevernie Perla Mate
25x50 cm R25C
KQ3TP000

18



Chevernie Perla Brillo
25x50 cm R25C
KQ3TP010

18

 
Bullnose Chevernie Gris Mate
5x25 cm S120 KQ3L5002

8



Chevernie Gris Mate
25x50 cm R25C
KQ3TP002

18



Chevernie Gris Brillo
25x50 cm R25C
KQ3TP012

18



Listelo Chevernie Gris
5,8x25 cm S260
KQ3ZZ002



Listelo Chevernie Gris
5,8x25 cm S260
KQ3ZZ002



Mosaico Chevernie Perla Mate
33x33 cm Y300 GQ308000



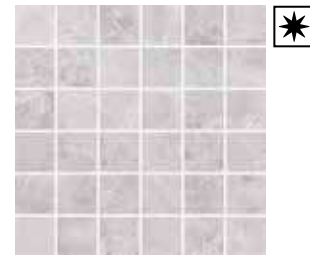

Mosaico Chevernie Gris Mate
33x33 cm Y300 GQ308002



 
Bullnose Chevernie Crema Mate
5x25 Cm S120 KQ3L5001

8



Chevernie Crema Mate
25x50 Cm R25C
KQ3TP001

18



Chevernie Crema Brillo
25x50 Cm R25C
KQ3TP011

18



Listelo Chevernie Crema
5,8x25 Cm S260 KQ3ZZ001



Listelo Chevernie Crema
5,8x25 Cm S260
KQ3ZZ001



Mosaico Chevernie Crema Mate
33x33 Cm Y300 GQ308001



CHEVERNIE

50X50 | 33x33
20" x 20" | 13" x 13"

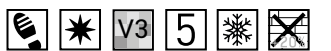

GLAZED PORCELAIN FLOOR TILES | PAVIMENTO PORCELÁNICO ESMALTADO | GRÈS CÉRAMÉ ÉMAILLÉ | GLASIERTE FEINSTEINZEUG BODENFLIESEN

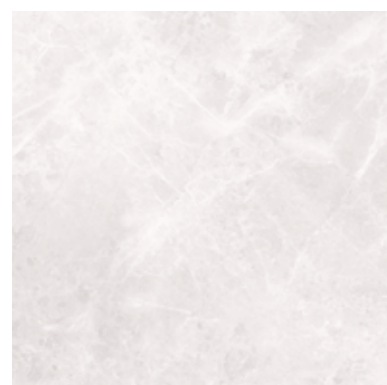

Chevernie Perla Mate
50x50 cm P50D
GQ313000

18

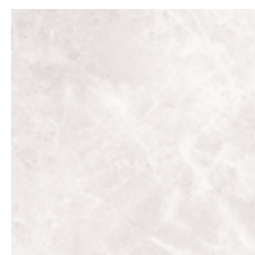

Chevernie Perla Mate
33x33 cm P33C
GQ308022



Chevernie Gris Mate
50x50 cm P50D
GQ313002

18



Chevernie Gris Mate
33x33 cm P33C
GQ308012

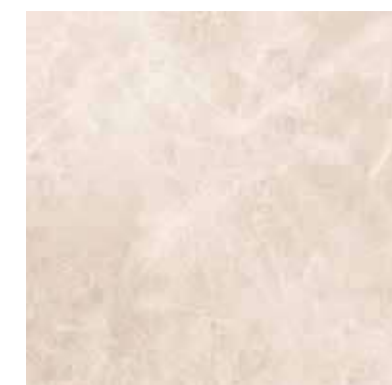

Chevernie Crema Mate
50x50 cm P50D
GQ313001

18



Chevernie Crema Mate
33x33 cm P33C
GQ308011



EXAMPLE OF BRICK COMPOSITION EJEMPLO DE COMPOSICIÓN



Chevernie Brick Perla Mate
8x25 cm



Chevernie Brick Gris Mate
8x25 cm



Chevernie Brick Crema Mate
8x25 cm



Chevernie Perla Mate
8x25 cm Y100 KQ3KS032 72



Chevernie Perla Brillo
8x25 cm Y100 KQ3KS020 72



Chevernie Gris Mate
8x25 cm Y100 KQ3KS042 72



Chevernie Gris Brillo
8x25 cm Y100 KQ3KS022 72



Chevernie Crema Mate
8x25 cm Y100 KQ3KS031 72

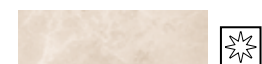

Chevernie Crema Brillo
8x25 cm Y100 KQ3KS021 72

PACKING LIST

formato/size	artículo/item	pzs-cj/pcs-box	m²cj/box	kg/cj/box	cj/box/epl	m²/epl	kg/epl
25x50/10"x20"	Base	11	1,38	21,78	36	49,68	807,08
8x25/3"x10"	Base	22	0,45	8,80	120	54,00	1079,00
5x25/2"x10"	Bullnose	22	0,28	3,52	150	41,25	551,00
33x33/13"x13"	Mosaico	10	1,09	19,00	36	39,24	707,00
50x50/20"x20"	Base	4	1,00	20,52	36	36,00	761,72
33x33/13"x13"	Base	11	1,21	22,55	48	58,08	1105,4
5,8x25/2,3"x10"	Listelo	19	0,28	5,13	120	33,06	638,60





WALL TILES | COLOUR ME BLANCO 25X50, LISTELO COLOUR ME COBALTO 3,8X50, COLOUR ME CONCEPT COBALTO 25X50
FLOOR TILES | MATCH SNOW 50X50



25x50 10" x 20" COLOUR ME

WHITE BODY WALL TILES | REVESTIMIENTO PASTA BLANCA | FAÏENCE PÂTE BLANCHE | WEISSSCHERBIGE WANDFLIESEN

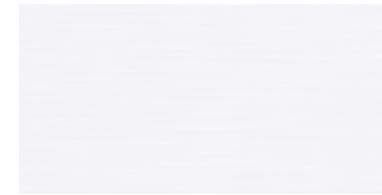

Colour Me Blanco 25x50 cm R25C KJKTP000 5

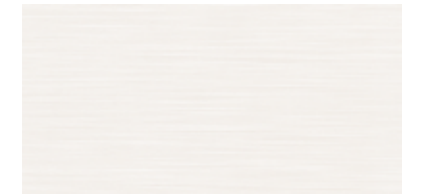

Colour Me Beige 25x50 cm R25C KJKTP001 5

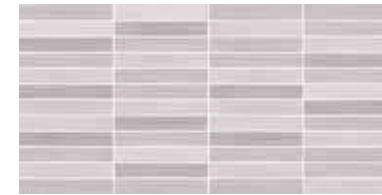

Colour Me Concept Gris 25x50 cm R25G KJKTP002

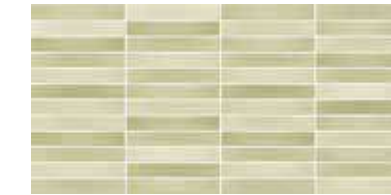

Colour Me Concept Lima 25x50 cm R25G KJKTP005



Colour Me Concept Visón 25x50 cm R25G KJKTP00C



List. Colour Me Gris 3,8x50 cm S320 KJKZT002



List. Colour Me Lima 3,8x50 cm S320 KJKZT005



List. Colour Me Visón 3,8x50 cm S320 KJKZT00C

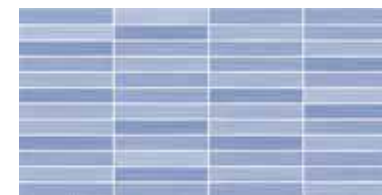

Colour Me Concept Cobalto 25x50 cm R25G KJKTP009

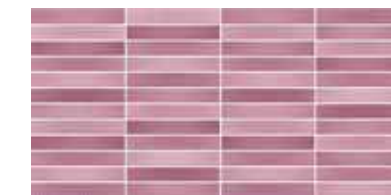

Colour Me Concept Frambuesa 25x50 cm R25G KJKTP00F



List. Colour Me Cobalto 3,8x50 cm S320 KJKZT000



List. Colour Me Frambuesa 3,8x50 cm S320 KJKZT010

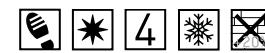

50X50 20" X 20" MATCH

GLAZED PORCELAIN FLOOR TILES | PAVIMENTO PORCELÁNICO ESMALTADO | GRÈS CÉRAME ÉMAILLÉ | GLASIERTE FEINSTEINZEUG BODENFLIESEN



Match Gris 50x50cm P50D GQ413002

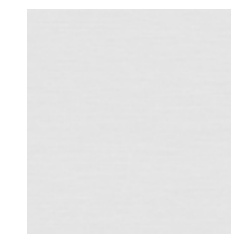

Match Snow 50x50cm P50D GQ413050



Match Cobalto 50x50cm P50D GQ413030



Match Negro 50x50cm P50D GQ41301K



Match Visón 50x50cm P50D GQ41300C

Rounded edge skirting 8x50 | Rodapié romano 8x50 S150
Gris GQ4VP002 Snow GQ4VP020
Cobalto GQ4VP000 Negro GQ4VP01K
Visón GQ4VP00C

PACKING LIST

formato/size	artículo/item	pzs-cj/pcs-box	m²/cj/box	kg/cj/box	cj/box/epl	m²/epl	kg/epl
25x50/10" x 20"	Base / Concept	11	1,38	21,78	36	49,68	807,08
3,8x50/1,5" x 20"	Listello	20	0,38	6,40	120	45,60	791,00
50x50/20" x 20"	Base	4	1,00	20,52	36	36,00	761,72
8x50/3" x 20"	Rodapié	10	0,40	9,60	120	48	1175



25x70
10" x 28" **DIADEME**

WHITE BODY WALL TILES

REVESTIMIENTO PASTA BLANCA

FAIÈNCE PÂTE BLANCHE

WEISSSCHERBIGE WANDFLIESEN



Diademe Blanco
25x70 cm R27C
KIYZA000



Diademe Crema
25x70 cm R27C
KIYZA001



Decor Blonda Blanco
25x70 cm S570
KIYZA020



Decor Blonda Crema
25x70 cm S570
KIYZA011



Listelo Blonda Blanco
4,6x70 cm S430
KIYMV005



Listelo Blonda Crema
4,6x70 cm S430
KIYMV00F



Diademe Concept Malva
25x70 cm R27G
KIYZA00F 3



Diademe Concept Champagne
25x70 cm R27G
KIYZA010 3



Diademe Concept Aguamarina
25x70 cm R27G
KIYZA009 3

WALL TILES | DIADEME CREMA 25X70, DIADEME BLONDA CREMA 25X70, DIADEME
CONCEPT CHAMPAGNE 25X70, LISTELO BLONDA CREMA 4,6X70

PACKING LIST

formato/size	artículo/item	pzs-cj/pcs-box	m²cj/box	kg/cj/box	cj/box/epl	m²/epl	kg/epl
25x70/10"x28"	Base / Concept	7	1,23	21,35	42	51,66	919,70
25x70/10"x28"	Decor	4	0,70	12,40	42	29,40	543,80
4,6x70/1,8"x28"	Listelo	6	0,19	3,90	144	27,82	584,60



WALL TILES | DISTRICT BLANCO 25X50, DISTRICT GRIS 25X50,
DISTRICT CONCEPT GRIS 25X50
FLOOR TILES | DISTRICT GRIS 50X50



25x50 10" x 20" **DISTRICT**

WHITE BODY WALL TILES

REVESTIMIENTO PASTA BLANCA

FAIËNCE PÂTE BLANCHE

WEISSSCHERBIGE WANDFLIESEN



District Blanco 25x50 cm R25C KIHTP001 **14**



District Gris 25x50 cm R25C KIHTP002 **15**



** District Concept Gris 25x50 cm R25G KIHTP012 **6**

Listelo District Gris 4,6x50 cm S320 KHAV002



District Beige 25x50 cm R25C KIHTP001 **14**



District Visón 25x50 cm R25C KIHTP00C **15**



** District Concept Visón 25x50 cm R25G KIHTP01C **6**

Listelo District Visón 4,6x50 cm S320 KHAV00C

50x50 20" X 20" **DISTRICT**



GLAZED PORCELAIN FLOOR TILES

PAVIMENTO PORCELÁNICO ESMALTADO

GRÈS CÉRAME ÉMAILLÉ

GLASIERTE FEINSTEINZEUG BODENFLIESEN



District Gris 50x50 P50C GIH13002

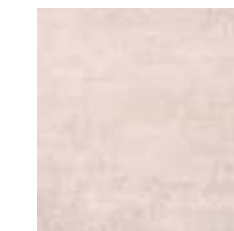

District Visón 50x50 P50C GIH1300C

Rounded edge skirting 8x50 | Rodapié romano 8x50 S150
Gris GIHVP002 Visón GIHVP00C

PACKING LIST

formato/size	artículo/item	pzs-cj/pcs-box	m²/cj/box	kg/cj/box	cj/box/epl	m²/epl	kg/epl
25x50/10" x 20"	Base / Concept	11	1,38	21,78	36	49,68	807,08
4,6x50/1,8" x 20"	Listelo	10	0,23	3,60	120	27,60	455,00
50x50/20" x 20"	Base	4	1,00	20,52	36	36,00	761,72
8x50/3" x 20"	Rodapié	10	0,40	9,60	120	48,00	1175,00

** 3 relieves diferentes decorativos/3 different structures patterns

ELVEN



ELVEN



WALL TILE | ELVEN CONCEPT BLANCO LAPPATO 150X37
FLOOR TILE | ELVEN GRAFITO LAPPATO 150X75



Elven Blanco Lappato
150x75 cm

P575F
GOH5T000 



Elven Grafito Lappato
150x75 cm

P575F
GOH5T00J 



Elven Blanco Lappato
150x37 cm

P537F
GOH5F000 



Elven Grafito Lappato
150x37 cm

P537F
GOH5F00J 

CL
CONVENIENT LARGE

CL
CONVENIENT LARGE



Elven Beige Lappato
150x75 cm

P575F
GOH5T001 10



Elven Óxido Lappato
150x75 cm

P575F
GOH5T006 10



Elven Beige Lappato
150x37 cm

P537F
GOH5F001 20

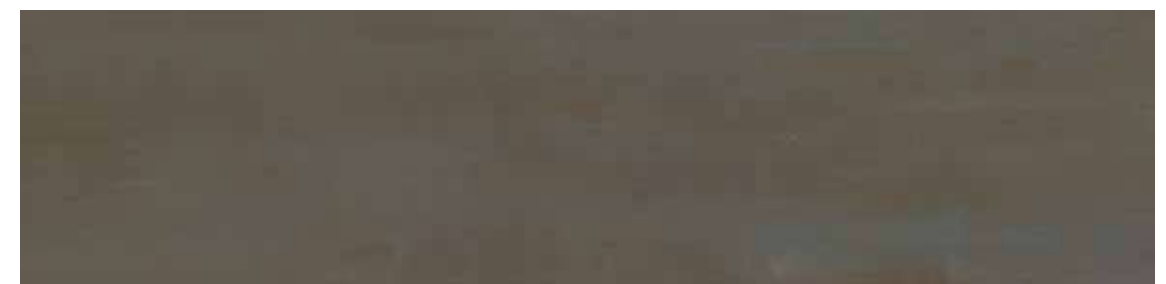

Elven Óxido Lappato
150x37 cm

P537F
GOH5F006 20

CL
CONVENIENT LARGE

CL
CONVENIENT LARGE

	Rounded edge skirting 8x75 Lappato Rodapié romano 8x75 Lappato	S330		Step (SR) 150x37 Lappato Peldaño simple (SR) 150x37 Lappato	S690		Double Step 150x37 Lappato Peldaño doble 150x37 Lappato	S750				
	Blanco Grafito	GOH3E000 GOH3E00J	Beige Óxido	GOH3E001 GOH3E006	Blanco Grafito	GOH5F010 GOH5F01J	Beige Óxido	GOH5F011 GOH5F016	Blanco Grafito	GOH5F020 GOH5F02J	Beige Óxido	GOH5F021 GOH5F026

PACKING LIST

formato/size	artículo/item	pzs-cj/pcs-box	m ² cj/box	kg/cj/box	cj/box/epl	m ² /ep1	kg/ep1
150x75/60"x30"	Lappato	1	1,12	26,80	48	53,76	1.309,40
150x37/60"x15"	Lappato	2	1,12	26,80	50	56,00	1.363,00
8x75/3"x30"	Rodapié Lappato	10	0,60	12,90	80	48,00	1055,00
150x37/60"x15"	Peldaño Lappato	2	1,11	26,80	Please ask for information / Consulte información		
150x37/60"x15"	Peldaño Doble Lappato	2	1,11	26,80	Please ask for information / Consulte información		

ELVEN



WALL TILE | ELVEN CONCEPT ÓXIDO LAPPATO 150X37, ELVEN BEIGE LAPPATO 150X37
FLOOR TILE | ELVEN CONCEPT ÓXIDO 150X75

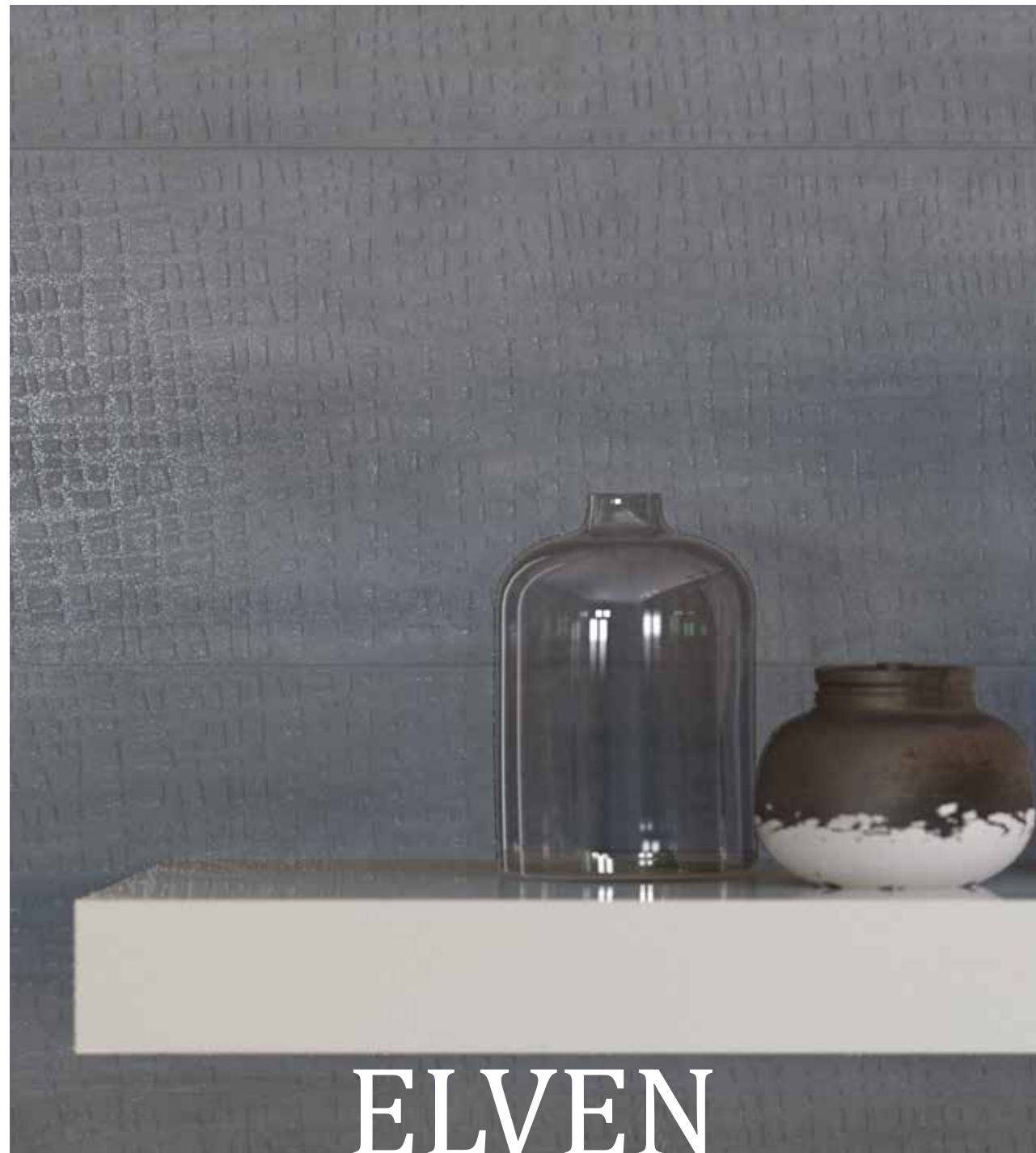

WALL TILE | ELVEN CONCEPT GRAFITO LAPPATO 150X37



WALL TILE | ELVEN CONCEPT GRAFITO LAPPATO 150X37
FLOOR TILE | ELVEN GRAFITO GRAFITO LAPPATO 150X75



Elven Blanco Lappato
150x37 cm

P537F
GOH5F000



Elven Concept Blanco Lappato
150x37 cm

P537H
GOH5F030



Elven Grafito Lappato
150x37 cm

P537F
GOH5F00J



Elven Concept Grafito Lappato
150x37 cm

P537H
GOH5F03J

CL
CONVENIENT LARGE



Elven Beige Lappato
150x37 cm

P537F
GOH5F001



Elven Concept Beige Lappato
150x37 cm

P537H
GOH5F031



Elven Óxido Lappato
150x37 cm

P537F
GOH5F006



Elven Concept Óxido Lappato
150x37 cm

P537H
GOH5F036

CL
CONVENIENT LARGE

PACKING LIST

formato/size	artículo/item	pzs-cj/pcs-box	m ² cj/box	kg/cj/box	cj/box/epl	m ² /epl	kg/epl
150x37/60"x15"	Lappato / Concept Lappato	2	1,12	26,80	50	56,00	1.363,00

EVOLUTION



WALL TILES | EVOLUTION TAUPE NATURAL 100X50
FLOOR TILES | EVOLUTION TAUPE NATURAL 75X75

EVOLUTION

100x50 | 75x75 | 60x60 | 37x75
 40" x 20" | 30" x 30" | 24" x 24" | 15" x 30"

COLOURED BODY PORCELAIN FLOOR TILES | PAVIMENTO PORCELÁNICO COLOREADO | GRÉS CÉRAME COLORE | DURCHGEFÄRBTE FEINSTEINZEUGBODENFLIESEN



Natural: Class 1 | R9
 Antislip: Class 3 | R10 | A+B+C



Evolution Blanco
 75x75 cm
 Evolution Blanco Lappato
 75x75 cm

P75C
 GJ30R000

P75F
 GJ30R010



Evolution Blanco
 60x60 cm
 Evolution Blanco Lappato
 60x60 cm

P64C
 GJ342000

P64F
 GJ342010



Evolution Gris
 75x75 cm
 Evolution Gris Lappato
 75x75 cm
 Evolution Gris Antislip Clase3/R10/A+B+C
 75x75 cm

P75C
 GJ30R002

P75F
 GJ30R012

P75E
 GJ30R022



Evolution Gris
 60x60 cm
 Evolution Gris Lappato
 60x60 cm

P64C
 GJ342002

P64F
 GJ342012



Evolution Blanco
 100x50 cm

P100C
 GJ321000

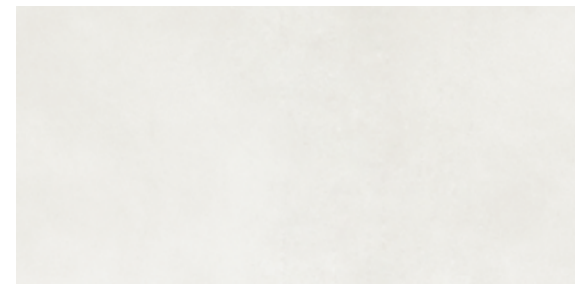

Evolution Blanco
 37x75 cm
 Evolution Blanco Lappato
 37x75 cm

P37C
 GJ3AC000

P37F
 GJ3AC010



Evolution Gris
 100x50 cm

P100C
 GJ321002



Evolution Gris
 37x75 cm
 Evolution Gris Lappato
 37x75 cm
 Evolution Gris Antislip Clase3/R10/A+B+C
 37x75 cm

P37C
 GJ3AC002

P37F
 GJ3AC012

P37E
 GJ3AC062



Mosaico Evolution Blanco
 30x30 cm GJ304000 Y300

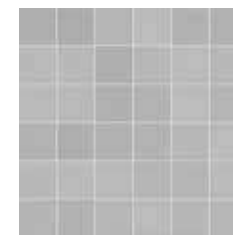

Mosaico Evolution Gris
 30x30 cm GJ304002 Y300



Evolution Grafito 75x75 cm P75D GJ30R00J
 Evolution Grafito Lappato 75x75 cm P75F GJ30R01J
 Evolution Grafito Antislip Class3/R10/A+B+C P75E GJ30R02J



Evolution Grafito 60x60 cm P64D GJ34200J
 Evolution Grafito Lappato 60x60 cm P64F GJ34201J



Evolution Negro 75x75 cm P75D GJ30R00K
 Evolution Negro Lappato 75x75 cm P75F GJ30R01K



Evolution Negro 60x60 cm P64D GJ34200K
 Evolution Negro Lappato 60x60 cm P64F GJ34201K



Evolution Grafito 100x50 cm P100D GJ32100J



Evolution Grafito 37x75 cm P37D GJ3AC00J
 Evolution Grafito Lappato 37x75 cm P37F GJ3AC01J
 Evolution Grafito Antislip Class3/R10/A+B+C P37E GJ3AC06J



Evolution Negro 100x50 cm P100D GJ32100K

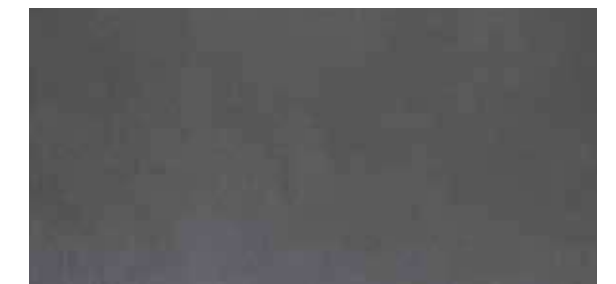

Evolution Negro 37x75 cm P37D GJ3AC00K
 Evolution Negro Lappato 37x75 cm P37F GJ3AC01K

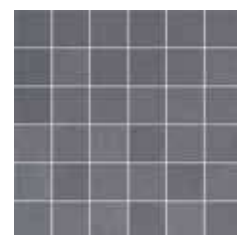

Mosaico Evolution Grafito 30x30 cm GJ30400J Y300

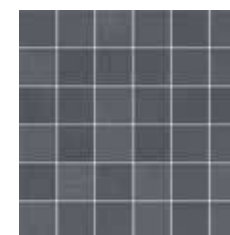

Mosaico Evolution Negro 30x30 cm GJ30400K Y300



Evolution Beige 75x75 cm P75C GJ30R001
 Evolution Beige Lappato 75x75 cm P75F GJ30R011
 Evolution Beige Antislip 75x75 cm P75E GJ30R021



Evolution Beige 60x60 cm P64C GJ342001
 Evolution Beige Lappato 60x60 cm P64F GJ342011



Evolution Taupé 75x75 cm P75D GJ30R00A
 Evolution Taupé Lappato 75x75 cm P75F GJ30R01A
 Evolution Taupé Antislip 75x75 cm P75E GJ30R02A

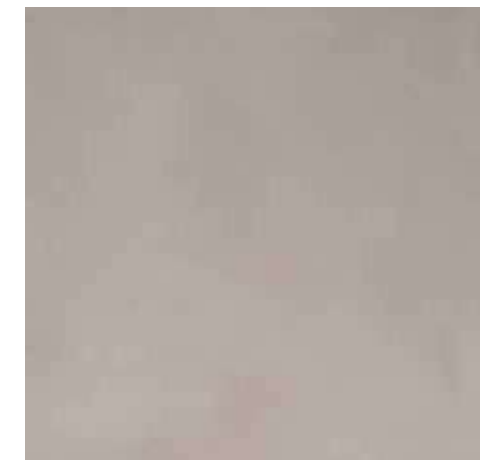

Evolution Taupé 60x60 cm P64D GJ34200A
 Evolution Taupé Lappato 60x60 cm P64F GJ34201A



Evolution Beige 100x50 cm P100C GJ321001



Evolution Beige 37x75 cm P37C GJ3AC001
 Evolution Beige Lappato 37x75 cm P37F GJ3AC011
 Evolution Beige Antislip 37x75 cm P37E GJ3AC061



Evolution Taupé 100x50 cm P100D GJ32100A



Evolution Taupé 37x75 cm P37D GJ3AC00A
 Evolution Taupé Lappato 37x75 cm P37F GJ3AC01A
 Evolution Taupé Antislip 37x75 cm P37E GJ3AC06A

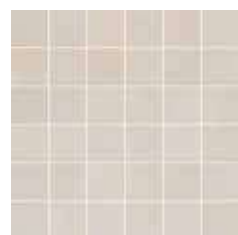

Mosaico Evolution Beige 30x30 cm GJ304001 Y300

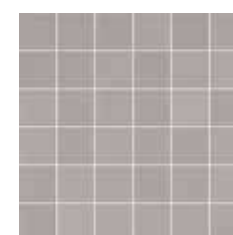

Mosaico Evolution Taupé 30x30 cm GJ30400A Y300

EVOLUTION 100x50 | 75x75 | 60x60 | 37x75

40" x 20" | 30" x 30" | 24" x 24" | 15" x 30"

COLOURED BODY PORCELAIN FLOOR TILES | PAVIMENTO PORCELÁNICO COLOREADO
GRES CERÁME COLORE | DURCHGEFÄRBTE FEINSTEINZEUGBODENFLIESEN

Natural: Clase I | R9
Antislip: Clase 3 | R10 | A+B+C

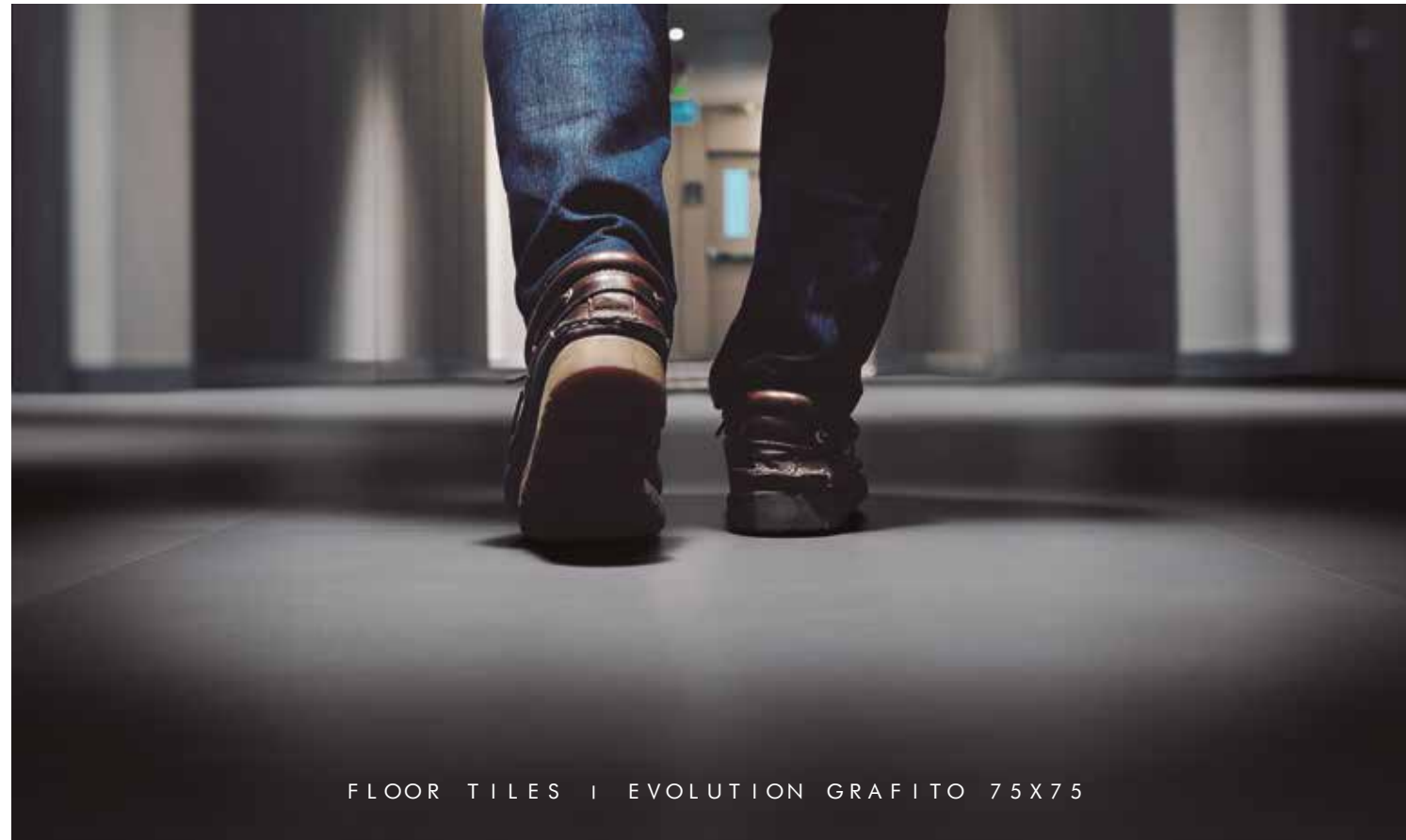

FLOOR TILES | EVOLUTION GRAFITO 75X75



Rounded edge skirting 8x50 Rodapié romano 8x50 S150			
Blanco	GJ3VP000	Gris	GJ3VP002
Beige	GJ3VP001	Grafito	GJ3VP00J
Taupé	GJ3VP00A	Negro	GJ3VP00K
Rounded edge skirting 8x60 Rodapié romano 8x60 S280			
Blanco	GJ3RQ000	Gris	GJ3RQ002
Beige	GJ3RQ001	Grafito	GJ3RQ00J
Taupé	GJ3RQ00A	Negro	GJ3RQ00K
Rounded edge skirting 8x60 Lappato Rodapié romano 8x60 Lappato S320			
Blanco	GJ3RQ010	Gris	GJ3RQ012
Beige	GJ3RQ011	Grafito	GJ3RQ01J
Taupé	GJ3RQ01A	Negro	GJ3RQ01K
Rounded edge skirting 8x75 Rodapié romano 8x75 S290			
Blanco	GJ33E000	Gris	GJ33E002
Beige	GJ33E001	Grafito	GJ33E00J
Taupé	GJ33E00A	Negro	GJ33E00K
Rounded edge skirting 8x75 Lappato Rodapié romano 8x75 Lappato S330			
Blanco	GJ33E010	Gris	GJ33E012
Beige	GJ33E011	Grafito	GJ33E01J
Taupé	GJ33E01A	Negro	GJ33E01K

Step 30x60 Peldaño simple 30x60 S500			
Blanco	GJ30S000	Gris	GJ30S002
Beige	GJ30S001	Grafito	GJ30S00J
Taupé	GJ30S00A	Negro	GJ30S00K
Step 30x60 Lappato Peldaño simple 30x60 Lappato S520			
Blanco	GJ30S010	Gris	GJ30S012
Beige	GJ30S011	Grafito	GJ30S01J
Taupé	GJ30S01A	Negro	GJ30S01K
Step 37x75 Peldaño simple 37x75 S560			
Blanco	GJ3AC020	Gris	GJ3AC022
Beige	GJ3AC021	Grafito	GJ3AC02J
Taupé	GJ3AC02A	Negro	GJ3AC02K
Step 37x75 Lappato Peldaño simple 37x75 Lappato S600			
Blanco	GJ3AC030	Gris	GJ3AC032
Beige	GJ3AC031	Grafito	GJ3AC03J
Taupé	GJ3AC03A	Negro	GJ3AC03K
Step 37x75 Antislip Peldaño simple 37x75 Antislip S560			
Beige	GJ3AC071	Taupé	GJ3AC07A
Gris	GJ3AC072	Grafito	GJ3AC07J
Step 100x50 Peldaño simple 100x50 S600			
Blanco	GJ321010	Gris	GJ321012
Beige	GJ321011	Grafito	GJ32101J
Taupé	GJ32101A	Negro	GJ32101K

Double Step 30x60 Peldaño doble 30x60 S650			
Blanco	GJ30S020	Gris	GJ30S022
Beige	GJ30S021	Grafito	GJ30S02J
Taupé	GJ30S02A	Negro	GJ30S02K
Double Step 30x60 Lappato Peldaño doble 30x60 Lappato S670			
Blanco	GJ30S030	Gris	GJ30S032
Beige	GJ30S031	Grafito	GJ30S03J
Taupé	GJ30S03A	Negro	GJ30S03K
Double Step 37x75 Peldaño doble 37x75 S690			
Blanco	GJ3AC040	Gris	GJ3AC042
Beige	GJ3AC041	Grafito	GJ3AC04J
Taupé	GJ3AC04A	Negro	GJ3AC04K
Double Step 37x75 Lappato Peldaño doble 37x75 Lappato S710			
Blanco	GJ3AC050	Gris	GJ3AC052
Beige	GJ3AC051	Grafito	GJ3AC05J
Taupé	GJ3AC05A	Negro	GJ3AC05K
Double Step 37x75 Antislip Peldaño doble 37x75 Antislip S690			
Beige	GJ3AC081	Taupé	GJ3AC08A
Gris	GJ3AC072	Grafito	GJ3AC07J
Double Step 100x50 Peldaño doble 100x50 S720			
Blanco	GJ321030	Gris	GJ321032
Beige	GJ321031	Grafito	GJ32103J
Taupé	GJ32103A	Negro	GJ32103K

PACKING LIST

formato/size	artículo/item	pzs-cj/pcs-box	m²/cj/box	kg/cj/box	cj/box/epl	m²/epl	kg/epl
100x50/40" x 20"	Base/ Lappato	2	1,00	23,60	28	28,00	683,80
75x75/30" x 30"	Base/ Lappato/Antislip	2	1,13	24,62	42	47,46	1057,04
37x75/15" x 30"	Base/ Lappato/Antislip	4	1,13	24,24	48	54,24	1186,52
60x60/24" x 24"	Base/Lappato	3	1,08	22,53	40	43,20	924,20
30x30/12" x 12"	Mosaico	11	1,00	20,46	36	36,00	759,56
8x50/3" x 20"	Rodapié Base	10	0,40	9,60	120	48,00	1175,00
8x60/3" x 24"	Rodapié Base/Lappato	10	0,48	11,30	80	38,40	943,00
8x75/3" x 30"	Rodapié Base/Lappato	10	0,60	12,90	80	48,00	1055,00
30x60/12" x 24"	Peldaño Base/Lappato	6	1,08	20,58	Please ask for information / Consulte información		
37x75/15" x 30"	Peldaño Base/Lappato/Antislip	4	1,11	24,24	Please ask for information / Consulte información		
30x60/12" x 24"	Peldaño Doble Base/Lappato	2	0,36	13,28	Please ask for information / Consulte información		
37x75/15" x 30"	Peldaño Doble Base/Lappato/Antislip	2	0,56	12,12	Please ask for information / Consulte información		
100x50/40" x 20"	Peldaño Base	2	1,00	25,20	Please ask for information / Consulte información		
100x50/40" x 20"	Peldaño Doble Base	2	1,00	28,34	Please ask for information / Consulte información		

WALL TILES | EVOLUTION GRIS 37X75
FLOOR TILES | EVOLUTION GRIS 75X75



25x70 EVOLUTION

10" x 28"

WHITE BODY WALL TILES

REVESTIMIENTO PASTA BLANCA

FAIÈNCE PÂTE BLANCHE

WEISSSCHERBIGE WANDFLIESEN



Evolution White
25x70 cm

R27C
KJ3ZA000 10



Evolution Cream
25x70 cm

R27C
KJ3ZA010 10



Evolution Concept White
25x70 cm

R27G
KJ3ZA020 5



Evolution Concept Cream
25x70 cm

R27G
KJ3ZA030 5



Evolution Gris
25x70 cm

R27D
KJ3ZA002 10



Evolution Taupé
25x70 cm

R27D
KJ3ZA00A 10



Evolution Concept Gris
25x70 cm

R27G
KJ3ZA012 5



Evolution Concept Taupé
25x70 cm

R27G
KJ3ZA01A 5

Perfil Acero Plata
1,5x70 cm

S300
KZD2800L

Perfil Acero Bronce
1,5x70 cm

S300
KZD2800M

WALL TILE | EVOLUTION CREAM 25X70, EVOLUTION CONCEPT CREAM 25X70,
EVOLUTION CONCEPT TAUPÉ 25X70,
FLOOR TILE | EVOLUTION TAUPÉ 75X75

PACKING LIST

formato/size	artículo/item	pzs-cj/pcs-box	m²/cj/box	kg/cj/box	cj/box/epl	m²/epl	kg/epl
25x70/9" x 28"	Base/Concept	7	1,23	21,35	42	51,66	919,70
1,5x70/1,8" x 28"	Perfil	6	0,06	0,72	400	25,20	311,00

EVOQUE



WALL TILES | EVOQUE CONCEPT MARFIL MATE 150X37
FLOOR TILE | EVOQUE MARFIL MATE 150X75

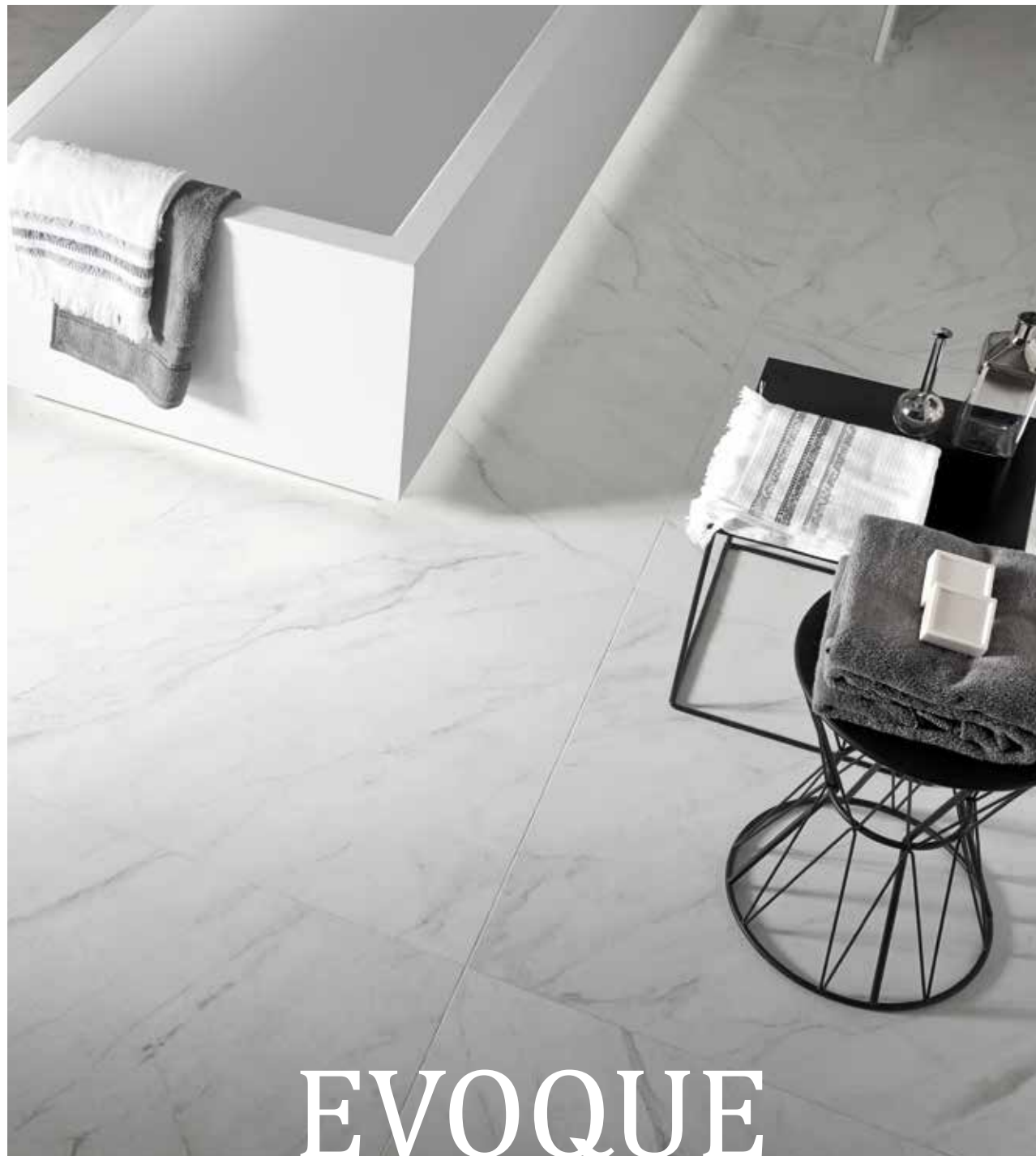

FLOOR TILE | EVOQUE BLANCO MATE 150X75



FLOOR TILE | EVOQUE BLANCO MATE 150X75, EVOQUE BLANCO MATE 150X37

EVOQUE



WALL TILES | EVOQUE BLANCO MATE 75X75
FLOOR TILES | EVOQUE BLANCO MATE 75X75

EVOQUE

150x75 | 150x37 | 75x75 | 60x60 | 37x75
 60" x30" | 60" x15" | 30" x30" | 24" x24" | 15" x30"

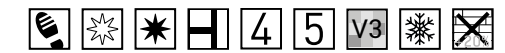

COLOURED BODY PORCELAIN FLOOR TILES | PAVIMENTO PORCELÁNICO COLOREADO | GRÉS CÉRAME COLORE | DURCHGEFÄRBTE FEINSTEINZEUGBODENFLIESEN *
 GLAZED PORCELAIN FLOOR TILES | PAVIMENTO PORCELÁNICO ESMALTADO | GRÉS CÉRAME EMAILÉ | GLASIERTE FEINSTEINZEUG BODENFLIESEN **



Evoque Blanco Mate
150x75 cm

P575C
GJNZ000 10



Evoque Blanco Mate
75x75 cm

P75C
GJN0R010 11



Evoque Blanco Brillo
75x75 cm

P75C
GJN0R000 11



Evoque Blanco Mate
150x37 cm

P537C
GJN5F000 20



Evoque Blanco Mate
37x75 cm

P37C
GJNAC010 22



Evoque Blanco Brillo
37x75 cm

P37C
GJNAC000 22

CL CONVENIENT LARGE

* 150X75 / 150X37

** 75X75 / 37X75

Rounded edge skirting 8x75 Matt Rodapié romo 8x75 Mate				S290
Bianco Crema	GJN3E010 GJN3E021	Marfil Gris	GJN3E031 GJN3E012	
Rounded edge skirting 8x75 Gloss Rodapié romo 8x75 Brillo				S290
Bianco Crema	GJN3E000 GJN3E001	Marfil Gris	GJN3E011 GJN3E002	

Step 37x75 Matt Peldaño simple 37x75 Mate				S560
Bianco Crema	GJNAC030 GJNAC061	Marfil Gris	GJNAC071 GJNAC032	
Step 37x75 Gloss Peldaño simple 37x75 Brillo				S560
Bianco Crema	GJNAC020 GJNAC041	Marfil Gris	GJNAC051 GJNAC022	

Double Step 37x75 Matt Peldaño doble 37x75 Mate				S690
Bianco Crema	GJNAC050 GJNAC101	Marfil Gris	GJNAC111 GJNAC052	
Double Step 37x75 Gloss Peldaño doble 37x75 Brillo				S690
Bianco Crema	GJNAC040 GJNAC081	Marfil Gris	GJNAC091 GJNAC042	



Evoque Blanco Mate
60x60 cm

P64C
GJN42000 10



Mosaico Evoque Blanco Mate
30x30 cm
GJN04000 Y300

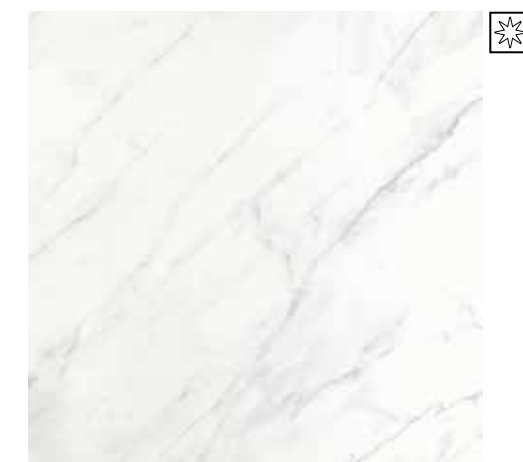

Evoque Blanco Brillo
60x60 cm

P64C
GJN42010 10

EVOQUE

150x75 | 150x37 | 75x75 | 60x60 | 37x75
 60" x30" | 60" x15" | 30" x30" | 24" x24" | 15" x30"



COLOURED BODY PORCELAIN FLOOR TILES | PAVIMENTO PORCELÁNICO COLOREADO | GRÉS CÉRAME COLORÉ | DURCHGEFÄRBTE FEINSTEINZEUGBODENFLIESEN *
 GLAZED PORCELAIN FLOOR TILES | PAVIMENTO PORCELÁNICO ESMALTADO | GRÉS CÉRAME EMAILLÉ | GLASIERTE FEINSTEINZEUG BODENFLIESEN **



Evoque Marfil Mate
150x75 cm

P575C
GJNZZ001 10



Evoque Marfil Mate
75x75 cm

P75C
GJN0R031 14



Evoque Marfil Brillo
75x75 cm

P75C
GJN0R011 14



Evoque Marfil Mate
150x37 cm

P537C
GJN5F001 20



Evoque Marfil Mate
37x75 cm

P37C
GJNAC031 28



Evoque Marfil Brillo
37x75 cm

P37C
GJNAC011 28

CL
CONVENIENT LARGE

*150X75 / 150X37

**75X75 / 37X75

PACKING LIST

formato/size	artículo/item	pzs-cj/pcs-box	m ² cj/box	kg/cj/box	cj/box/epl	m ² /epl	kg/epl
150x75/60" x30"	Base	1	1,12	26,80	48	53,76	1.309,40
150x37/60" x15"	Base	2	1,12	26,80	50	56,00	1.363,00
75x75/30" x30"	Gloss / Brillo Matt / Mate	2	1,13	24,62	42	47,46	1057,04
37x75/15" x30"	Gloss / Brillo Matt / Mate	4	1,13	24,24	48	54,24	1186,52
60x60/24" x24"	Gloss / Brillo Matt / Mate	3	1,08	22,53	40	43,20	924,20
30x30/12" x12"	Mosaico	11	1,00	20,46	36	36,00	759,56
8x75/3" x30"	Rodapié Gloss / Brillo Matt / Mate	10	0,60	12,90	80	48,00	1055,00
37x75/15" x30"	Peldaño Gloss / Brillo Matt / Mate	4	1,11	24,24	Please ask for information / Consulte información		
37x75/15" x30"	Peldaño Doble Gloss / Brillo Matt / Mate	2	0,56	12,12	Please ask for information / Consulte información		



Mosaico Evoque Marfil Mate
30x30 cm
GJN04011 Y300



Crema Marfil
60x60 cm

P64C
G2342001 12



Evoque Gris Mate
 75x75 cm
 P75C
 GJN0R012 13



Evoque Gris Brillo
 75x75 cm
 P75C
 GJN0R002 13



Evoque Crema Mate
 75x75 cm
 P75C
 GJN0R021 8



Evoque Crema Brillo
 75x75 cm
 P75C
 GJN0R001 8



Evoque Gris Mate
 37x75 cm
 P37C
 GJNAC012 26



Evoque Gris Brillo
 37x75 cm
 P37C
 GJNAC002 26



Evoque Crema Mate
 37x75 cm
 P37C
 GJNAC021 16



Evoque Crema Brillo
 37x75 cm
 P37C
 GJNAC001 16

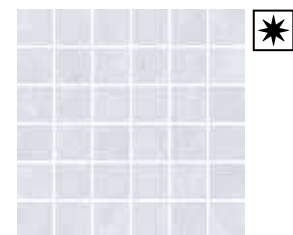

Mosaico Evoque Gris Mate
 30x30 cm GJN04002
 Y300

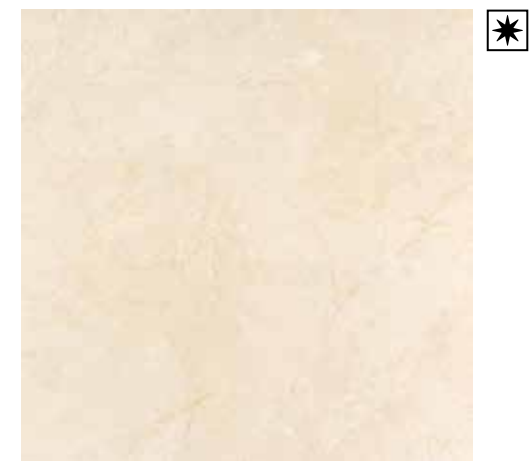

Evoque Crema Mate
 60x60 cm
 P64C
 GJN42001 10

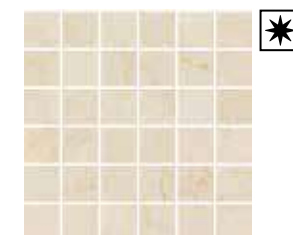

Mosaico Evoque Crema Mate
 30x30 cm
 GJN04001 Y300

EVOQUE

HOTEL *****
SHAPHIRE

WALL TILES | EVOQUE BLANCO MATE 150X37, EVOQUE CONCEPT BLANCO MATE 150X37
FLOOR TILE | EVOQUE BLANCO MATE 150X75



150x37
60" x 15" **EVOQUE**

COLOURED BODY PORCELAIN WALL TILES | REVESTIMIENTO PORCELÁNICO COLOREADO | GRÉS CÉRAME COLORE | DURCHGEFÄRBTE FEINSTEINZEUGBODENFLIESEN



Evoque Blanco Mate
150x37 cm

P537C
GJN5F000 20

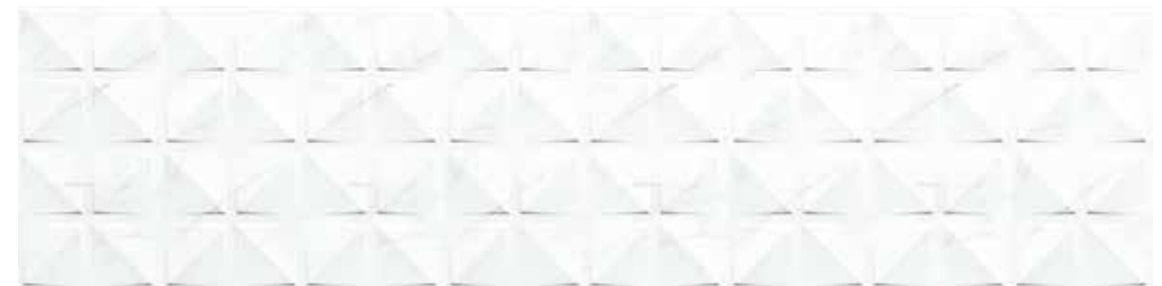

Evoque Concept Blanco Mate
150x37 cm

P537G
GJN5F010 12



Evoque Marfil Mate
150x37 cm

P537C
GJN5F001 20



Evoque Concept Marfil Mate
150x37 cm

P537G
GJN5F011 12

CL
CONVENIENT LARGE

PACKING LIST

formato/size	artículo/item	pzs-cj/pcs-box	m²cj/box	kg/cj/box	cj/box/epl	m²/epl	kg/epl
150x37/60"x15"	Base / Concept	2	1,12	26,80	50	56,00	1.363,00

EVOQUE



WALL TILE | EVOQUE BLANCO MATE 30X90, EVOQUE CONCEPT BLANCO MATE 30X90
FLOOR TILE | EVOQUE BLANCO MATE 75X75



Evoque Blanco Brillo
30x90 cm

R90D
KJNPG000 15



Crema Marfil
30x90 cm

R90D
K23PG001 15



Evoque Concept Blanco Brillo
30x90 cm

R90G
KJNPG020 11



Evoque Concept Crema Brillo
30x90 cm

R90G
KJNPG051 10

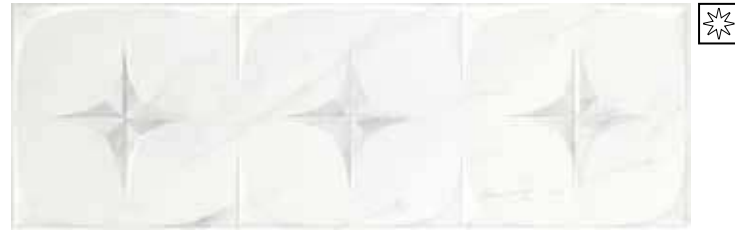

Evoque Art Blanco Brillo
30x90 cm

R90G
KJNPG040 11



Evoque Art Crema Brillo
30x90 cm

R90G
KJNPG071 10



Listelo Evoque Art Blanco Brillo
4,5x90 cm

S490
KJN3P000



Listelo Evoque Art Crema Brillo
4,5x90 cm

S490
KJN3P001



Perfil Acero Plata
1,5x90 cm

S330
K432L00L



Perfil Acero Bronce
1,5x90 cm

S330
K432L00M



Evoque Blanco Mate
30x90 cm

R90C
KJNPG010 15



Evoque Crema Mate
30x90 cm

R90C
KJNPG011 15



Evoque Concept Blanco Mate
30x90 cm

R90G
KJNPG030 12



Evoque Concept Crema Mate
30x90 cm

R90G
KJNPG031 10



Listelo Evoque Art Blanco Brillo
4,5x90 cm

S490
KJN3P000



Listelo Evoque Art Crema Brillo
4,5x90 cm

S490
KJN3P001



Perfil Acero Plata
1,5x90 cm

S330
K432L00L



Perfil Acero Bronce
1,5x90 cm

S330
K432L00M

PACKING LIST

formato/size	artículo/item	pzs-cj/pcs-box	m ² cj/box	kg/cj/box	cj/box/epl	m ² /epI	kg/epI
30x90/12" x 36"	Base/Concept/Art	4	1,08	18,48	51	55,08	983,84
30x90/12" x 36"	Decor	2	0,54	9,80	44	23,76	454,20
4,5x90/1,5" x 20"	Listelo	6	0,24	4,92	56	13,61	298,52
4,8x30/1,9" x 12"	Listelo	11	0,16	3,30	110	17,42	386,00
7x30/2,7" x 12"	Listelo	11	0,23	4,95	90	20,79	468,50
12,5x30/4,9" x 12"	Zócalo	6	0,22	4,80	110	24,75	551,00
1,5x90/1,8" x 36"	Perfil	6	0,08	0,90	336	27,22	325,40



Evoque Blanco Mate
30x90 cm R90C KJNPG010

15



Listelo Piaget Silver
4,8x30 cm S460 KJNH600L



Decor Piaget Blanco Mate (set 2 pz)
30x90 cm S630 KJNPG070



Zócalo Piaget Silver
12,5x30 cm S570 KJNTB00L



Evoque Blanco Mate
30x90 cm R90C KJNPG010

15



Listelo kubán Black
7x30 cm S320 KJNON000



Evoque Art Blanco Mate
30x90 cm R90G KJNPG050

10



Evoque Crema Mate
30x90 cm R90C KJNPG011

15



Listelo Piaget gold
4,8x30 cm S460 KJNH6004



Decor Piaget Crema Mate (set 2 pz)
30x90 cm S630 KJNPG101



Zócalo Piaget gold
12,5x30 cm S570 KJNTB004



Evoque Crema Mate
30x90 cm R90C KJNPG011

15



Listelo kubán Brown
7x30 cm S320 KJNON003



Evoque Art Crema Mate
30x90 cm R90G KJNPG081

10

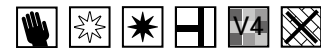

30x60
12" x 24" **EVOQUE**

WHITE BODY WALL TILES

REVESTIMIENTO PASTA BLANCA

FAÏENCE PÂTE BLANCHE

WEISSSCHERBIGE WANDFLIESEN



Evoque Blanco Brillo R36D
30x60 cm KJN05000 14



Evoque Crema Brillo R36D
30x60 cm KJN05001 14



Evoque Concept Blanco Brillo R36G
30x60 cm KJN05050 11



Evoque Concept Crema Brillo R36G
30x60 cm KJN05051 11



Perfil Acero Plata S270
1,5x60 cm KEEN400A



Perfil Acero Bronce S270
1,5x60 cm KEEN400M



Evoque Blanco Mate R36C
30x60 cm KJN05020 14

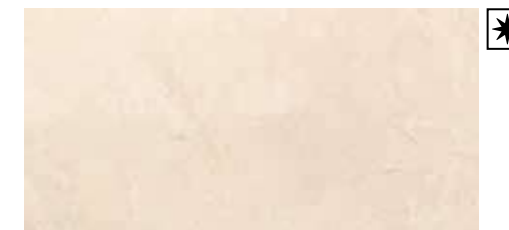

Evoque Crema Mate R36C
30x60 cm KJN05021 14



Evoque Concept Blanco Mate R36G
30x60 cm KJN05060 11



Evoque Concept Crema Mate R36G
30x60 cm KJN05061 11

WALL TILE | EVOQUE BLANCO MATE 30X60, EVOQUE CONCEPT BLANCO MATE 30X60
FLOOR TILE | EVOQUE BLANCO MATE 75X75,

PACKING LIST

formato/size	articulo/item	pzs-cj/pcs-box	m ² cj/box	kg/cj/box	cj/box/epl	m ² /epl	kg/epl
30x60/12"x24"	Base/Concept	6	1,08	18,48	40	43,20	762,20
1,5x60/1,8"x24"	Perfil	6	0,05	0,54	500	27,00	293,00



WALL TILE | EVOQUE BLANCO MATE 8X25



8x25
3" x 10" **EVOQUE**

WHITE BODY WALL TILES

REVESTIMIENTO PASTA BLANCA

FAIENCE PÂTE BLANCHE

WEISSSCHERBIGE WANDFLIESEN



Evoque Blanco Mate
8x25 cm



Y100
KJNKS010 72



Evoque Blanco Brillo
8x25 cm



Y100
KJNKS000 72

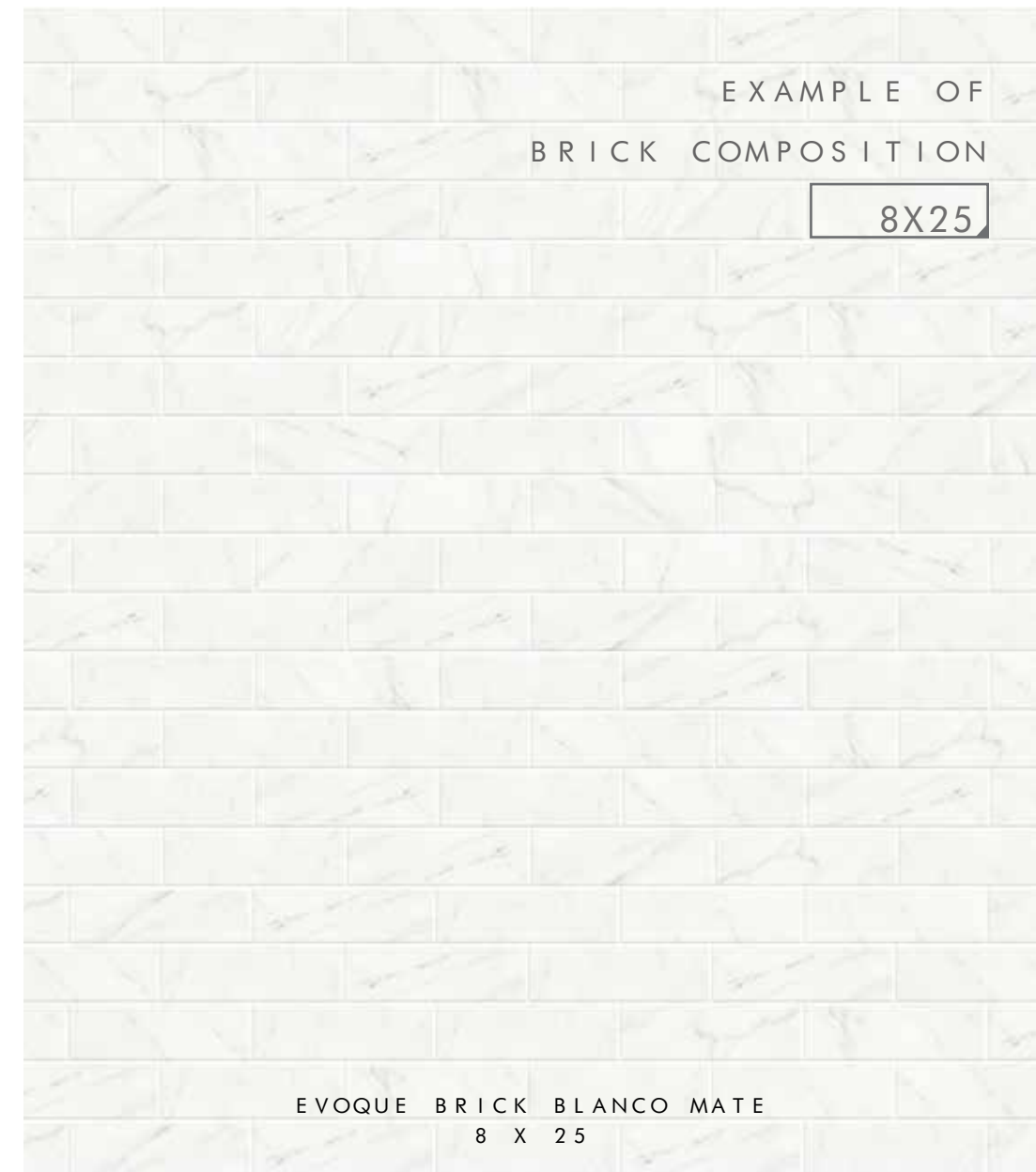

EVOQUE BRICK BLANCO MATE
8 X 25

PACKING LIST

formato/size	artículo/item	pzs-cj/pcs-box	m²cj/box	kg/cj/box	cj/box/epl	m²/epl	kg/epl
8x25 / 3"X10"	Base	22	0,45	8,80	120	54,00	1079,00

FRAME

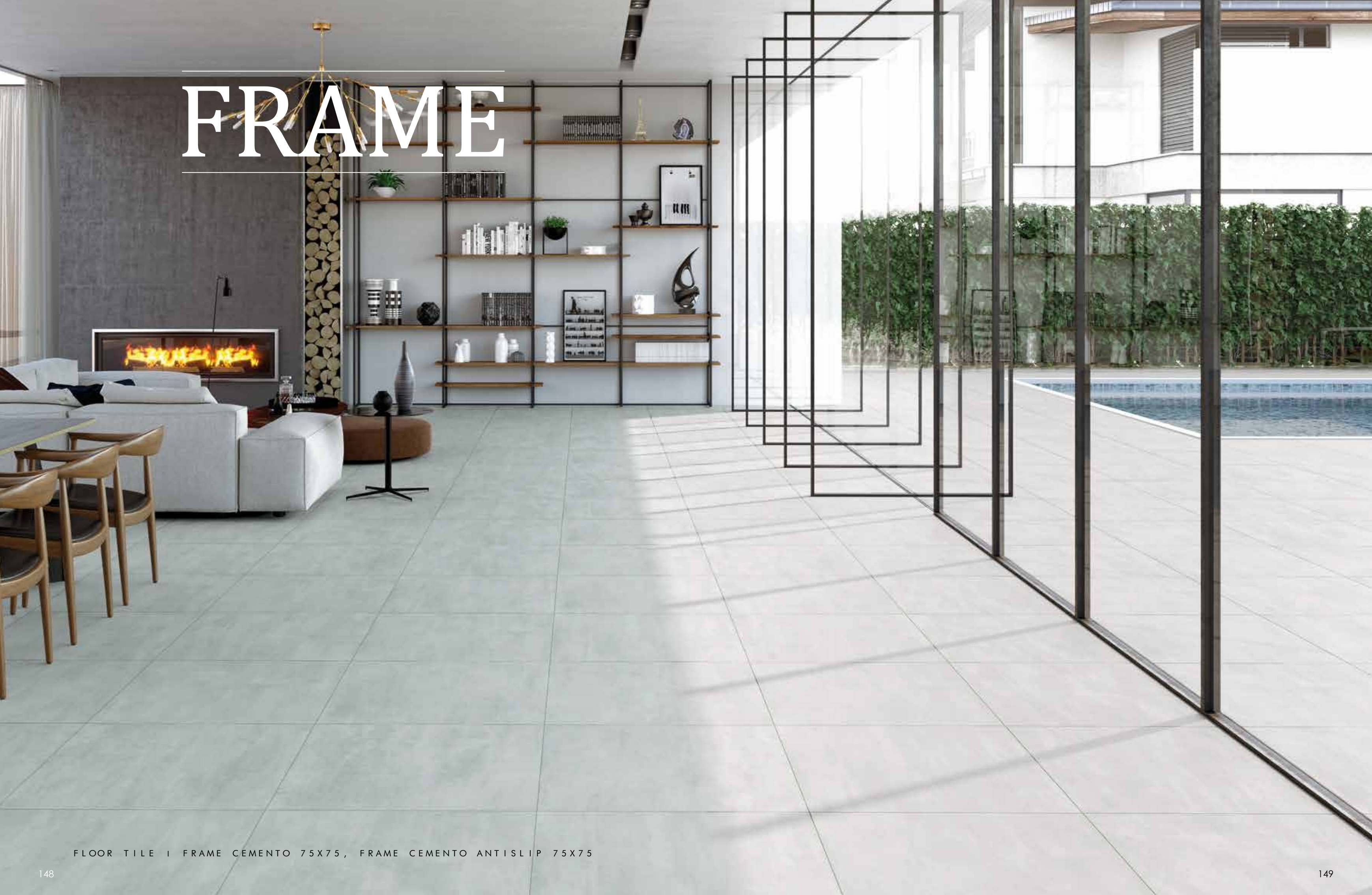

FLOOR TILE | FRAME CEMENTO 75X75, FRAME CEMENTO ANTISLIP 75X75

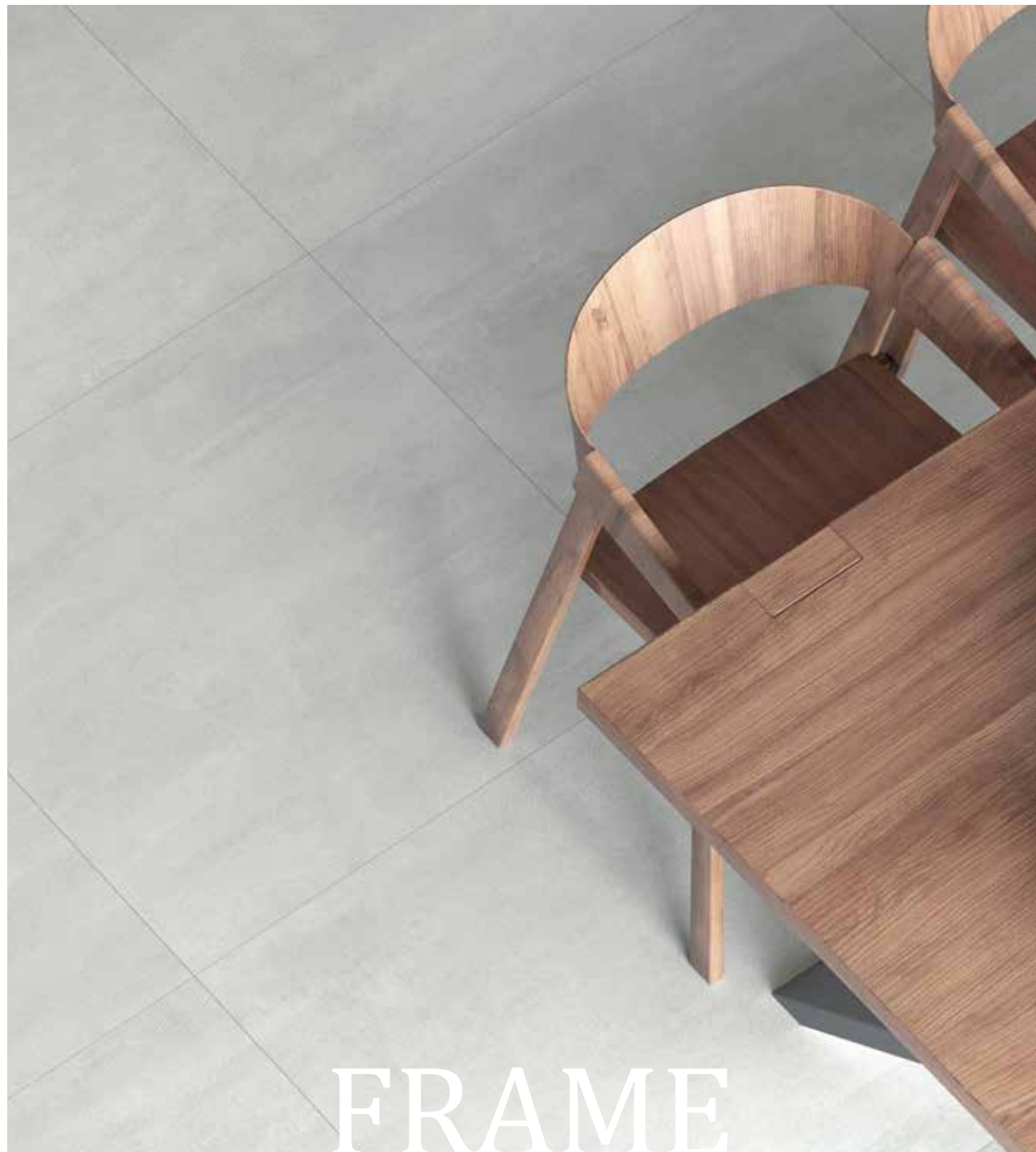

FRAME

FLOOR TILE | FRAME BLANCO 75X75



WALL TILE | FRAME BLANCO 37X75
FLOOR TILE | FRAME BLANCO 75X75

FRAME

75x75 | 37x75 | 60x60
30" x 30" | 15" x 30" | 24" x 24"

COLOURED BODY PORCELAIN FLOOR TILES | PAVIMENTO PORCELÁNICO COLOREADO | GRÉS CÉRAME COLORE | DURCHGEFÄRBTE FEINSTEINZEUGBODENFLIESEN



Natural: Clase 1 | R9 | A
Antislip: Clase 3 | R11 | A+B+C



Frame Blanco
75x75 cm P75D GOV0R000 16

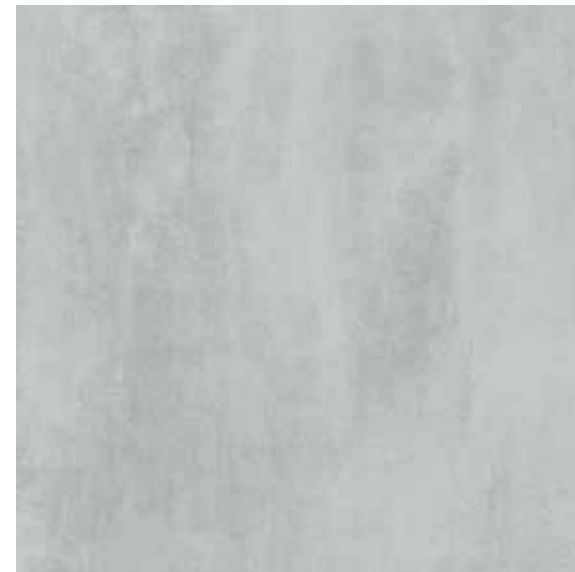

Frame Cemento
75x75 cm P75D GOV0R00C 16
Frame Cemento Antislip **Clase3/R11/A+B+C** P75E GOV0R01C 16



Frame Grafito
75x75 cm P75D GOV0R00J 16
Frame Grafito Antislip **Clase3/R11/A+B+C** P75E GOV0R01J 16



Frame Blanco
37x75 cm P37D GOVAC000 32



Frame Cemento
37x75 cm P37D GOVAC00C 32
Frame Cemento Antislip **Clase3/R11/A+B+C** P37E GOVAC01C 32



Frame Grafito
37x75 cm P37D GOVAC00J 32
Frame Grafito Antislip **Clase3/R11/A+B+C** P37E GOVAC01J 32



Frame Blanco
60x60 cm P64D GOV42000 18



Frame Cemento
60x60 cm P64D GOV4200C 18



Frame Grafito
60x60 cm P64D GOV4200J 18



Cube Frame Blanco
26x30 cm GOV5W000 Y500



Cube Frame Cemento
26x30 cm GOV5W00C Y500



Cube Frame Grafito
26x30 cm GOV5W00J Y500

FRAME

75x75 | 37x75 | 60x60
30" x 30" | 15" x 30" | 24" x 24"

COLOURED BODY PORCELAIN FLOOR TILES | PAVIMENTO PORCELÁNICO COLOREADO
GRES CERAME COLORE | DURCHGEFÄRBTE FEINSTEINZEUGBODENFLIESEN



Natural: Clase I | R9 | A
Antislip: Clase 3 | R11 | A+B+C



Frame Beige 75x75 cm P75D GOV0R001 16
Frame Beige Antislip 75x75 cm P75E GOV0R011 16



Frame Beige 37x75 cm P37D GOVAC001 32
Frame Beige Antislip 37x75 cm P37E GOVAR011 32



Cube Frame Beige 26x30 cm P64D GOV42001 18



Cube Frame Beige 26x30 cm GOV5W001 Y500



Frame Taupé 75x75 cm P75D GOV0R00A 16



Frame Taupé 37x75 cm P37D GOVAC00A 32



Cube Frame Taupé 26x30 cm P64D GOV4200A 18



Cube Frame Taupé 26x30 cm GOV5W00A Y500



WALL TILE | FRAME TAUPÉ 37X75
FLOOR TILE | FRAME BEIGE 75X75

	Rounded edge skirting 8x60 Rodapié romano 8x60 S280		Step 30x60 Peldaño simple 30x60 S500		Double Step 30x60 Peldaño doble 30x60 S650						
Blanco	GOVRQ000	Beige	GOVRQ001	Blanco	GOV05000	Beige	GOV05001	Blanco	GOV05010	Beige	GOV05011
Cemento	GOVRQ00C	Gratito	GOVRQ00J	Cemento	GOV0500C	Gratito	GOV0500J	Cemento	GOV0501C	Gratito	GOV0501J
Taupé	GOVRQ00A	Taupé	GOVRQ00A	Taupé	GOV0500A	Taupé	GOV0500A	Taupé	GOV0501A	Taupé	GOV0501A
	Rounded edge skirting 8x75 Rodapié romano 8x75 S290		Step 37x75 Peldaño simple 37x75 S560		Double Step 37x75 Peldaño doble 37x75 S690						
Blanco	GOV3E000	Beige	GOV3E001	Blanco	GOV08010	Beige	GOVAC021	Blanco	GOVAC010	Beige	GOVAC041
Cemento	GOV3E00C	Gratito	GOV3E00J	Cemento	GOVAC02C	Gratito	GOVAC03C	Cemento	GOVAC03C	Gratito	GOVAC03J
Taupé	GOV3E00A	Taupé	GOV3E00A	Taupé	GOVAC01A	Taupé	GOVAC03A	Taupé	GOVAC02A	Taupé	GOVAC03J
	Step 37x75 Antislip Peldaño simple 37x75 Antislip S560		Double Step 37x75 Antislip Peldaño doble 37x75 Antislip S690		Double Step 37x75 Antislip Peldaño doble 37x75 Antislip S690						
Beige	GOVAC031	Cemento	GOVAC04C	Beige	GOVAC031	Cemento	GOVAC04C	Beige	GOVAC051	Cemento	GOVAC06C
Gratito	GOVAC02J			Gratito	GOVAC02J			Gratito	GOVAC04J		

PACKING LIST

formato/size	artículo/item	pzs-cj/pcs-box	m²cj/box	kg/cj/box	cj/box/epl	m²/epl	kg/epl
75x75/30"x30"	Base / Antislip	2	1,13	24,62	42	47,46	1.057,04
37x75/15"x30"	Base / Antislip	4	1,13	24,24	48	54,24	1.186,52
60x60/24"x24"	Base	3	1,08	22,53	40	43,20	924,20
26x30/10"x12"	Cube	11	0,85	15,40	36	30,60	577,40
8x60/3"x24"	Rodapié	10	0,48	11,30	80	38,40	943,00
8x75/3"x30"	Rodapié	10	0,60	12,90	80	48,00	1055,00
30x60/12"x24"	Peldaño	6	1,08	22,58			Please ask for information / Consulte información
30x60/12"x24"	Peldaño Doble	2	0,36	13,28			Please ask for information / Consulte información
37x75/15"x30"	Peldaño Base/Antislip	4	1,11	24,24			Please ask for information / Consulte información
37x75/15"x30"	Peldaño Doble Base/Antislip	2	0,56	12,12			Please ask for information / Consulte información

FRAME



WALL TILE | FRAME BEIGE 30X90, FRAME ART BEIGE 30X90
FLOOR TILE | FRAME BEIGE 75X75

FRAME

WALL TILE | FRAME BLANCO 30X90, FRAME CONCEPT CEMENTO 30X90
FLOOR TILE | FRAME CEMENTO 75X75



30x90
12" x 36" **FRAME**

WHITE BODY WALL TILES

REVESTIMIENTO PASTA BLANCA

FAÏENCE PÂTE BLANCHE

WEISSSCHERBIGE WANDFLIESEN



Frame Blanco
30x90 cm

R90D
KOVPG000 14



Frame Beige
30x90 cm

R90D
KOVPG001 14



Frame Concept Blanco
30x90 cm

R90G
KOVPG010 5



Frame Concept Beige
30x90 cm

R90G
KOVPG011 5



Frame Concept Cemento
30x90 cm

R90G
KOVPG00C 5



Frame Concept Taupé
30x90 cm

R90G
KOVPG00A 5



Frame Art Blanco
30x90 cm

R90H
KOVPG020 6



Frame Art Beige
30x90 cm

R90H
KOVPG021 6



Perfil Acero Plata
1,5x90 cm

S330
K432L00L



Perfil Acero Bronce
1,5x90 cm

S330
K432L00M

PACKING LIST

formato/size	artículo/item	pzs-cj/pcs-box	m²cj/box	kg/cj/box	cj/box/epl	m²/epl	kg/epl
30x90/12"x36"	Base/Concept/Art	4	1,08	18,84	51	55,08	983,84
1,5x90/1,8"x36"	Perfil	6	0,08	0,90	336	27,22	325,40



WALL TILES | FRESH GRAFITO 25X70, FRESH BLANCO 25X70,
FRESH MODUL GRAFITO 25X70, LISTELO SPRAY GRAFITO 7,8X70
FLOOR TILES | MATCH SNOW 50X50

MATCH 50x50

20" X 20"

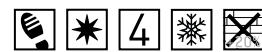

GLAZED PORCELAIN FLOOR TILES | PAVIMENTO PORCELÁNICO ESMALTADO | GRÉS CÉRAME ÉMAILLÉ | GLASIERTE FEINSTEINZEUG BODENFLIESEN

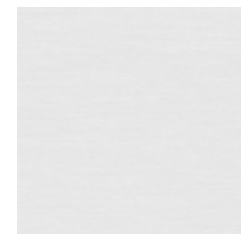

Match Snow P50D
50x50cm GQ413050

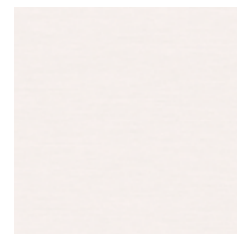

Match Cream P50D
50x50cm GQ413040

Rounded edge skirting 8x50 | Rodapié romano 8x50 S150
Snow GQ4VP020 Cream GQ4VP010

PACKING LIST

formato/size	artículo/item	pzs-cj/pcs-box	m²/cj/box	kg/cj/box	cj/box/epl	m²/epl	kg/epl
25x70/10" x 28"	Base / Modul	7	1,23	21,35	42	51,66	919,70
25x70/10" x 28"	Decor	3	0,52	9,6	42	22,00	426,20
7,8x70/3" x 28"	Listelo	6	0,33	6,12	80	26,21	512,60
30x30/12" x 12"	Malla	9	0,81	12,60	42	34,00	552,00
50x50/20" x 20"	Base	4	1,00	20,52	36	36,00	761,72
8x50/3" x 20"	Rodapié	10	0,40	9,60	120	48,00	1175



25x70 FRESH

10" x 28"

WHITE BODY WALL TILES | REVESTIMIENTO PASTA BLANCA | FAÏENCE PÂTE BLANCHE | WEISSSCHERBIGE WANDFLIESEN

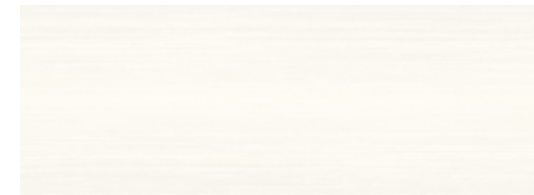

Fresh Blanco R27C
25x70 cm KEYZA000



Fresh Grafito R27C
25x70 cm KEYZA00J

Listelo Spray Grafito S470
7,8x70 cm KEYMN000



Fresh Modul Grafito R27E
25x70 cm KEYZA01J



** Decor Nippon Blanco (Set 3) S610
25x70 cm KEYZA010

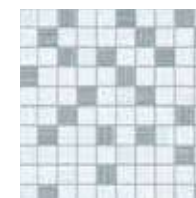

Malla Fresh Grafito
30x30 cm KEY0400J S540

** Precio por pieza / Price per piece



Fresh Beige R27C
25x70 cm KEYZA001



Fresh Visón R27C
25x70 cm KEYZA003

Listelo Spray Visón S470
7,8x70 cm KEYMN001

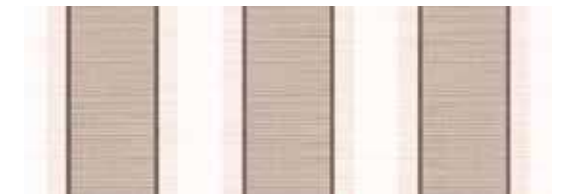

Fresh Modul Visón R27E
25x70 cm KEYZA013



** Decor Nippon Beige (Set 3) S610
25x70 cm KEYZA011

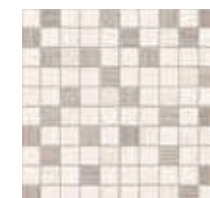

Malla Fresh Visón
30x30 cm KEY04003 S540

FUTURE





Future Beige 75x75 cm P75C G8V0R001 12
 Future Beige Lappato 75x75 cm P75F G8V0R011 12
 Future Beige Antislip Clase3/R11/A+B+C 75x75 cm P75E G8V0R031 12



Future Beige 60x60 cm P64C G8V42001 18
 Future Beige Lappato 60x60 cm P64F G8V42011 18



Future Cobre 75x75 cm P75D G8V0R01M 12
 Future Cobre Lappato 75x75 cm P75F G8V0R00M 12



Future Cobre 60x60 cm P64D G8V42003 18
 Future Cobre Lappato 60x60 cm P64F G8V4200M 18



Future Beige 100x50 cm P100C G8V21001 13
 Future Beige Lappato 100x50 cm P100E G8V21011 13



Future Beige 37x75 cm P37C G8VAC001 24
 Future Beige Lappato 37x75 cm P37F G8VAC011 24
 Future Beige Antislip Clase3/R11/A+B+C 37x75 cm P37E G8VAC071 24



Future Cobre 100x50 cm P100C G8V21003 14
 Future Cobre Lappato 100x50 cm P100E G8V2100M 14



Future Cobre 37x75 cm P37D G8VAC00M 24
 Future Cobre Lappato 37x75 cm P37F G8VAC01M 24

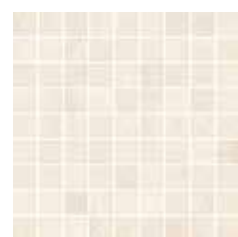

Mosaico Future Beige 30x30 cm G8V04001 Y600

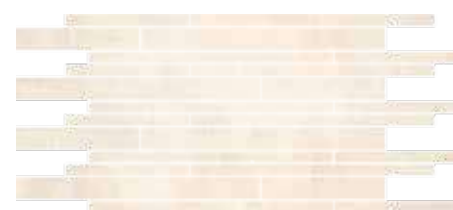

Muro Future Beige 26x58 cm Y500 G8V0K001

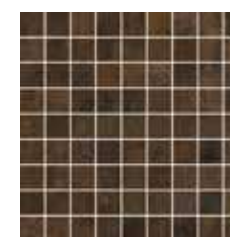

Mosaico Future Cobre 30x30 cm G8V0400M Y600



Muro Future Cobre 26x58 cm Y500 G8V0K00M



Future Blanco
75x75 cm
Future Blanco Lappato
75x75 cm

P75C
G8V0R000 12

P75F
G8V0R010 12



Future Blanco
60x60 cm
Future Blanco Lappato
60x60 cm

P64C
G8V42000 18

P64F
G8V42022 18



Future Gris
75x75 cm
Future Gris Lappato
75x75 cm
Future Gris Antislip Clase3/R11/A+B+C
75x75 cm

P75C
G8V0R032 12

P75F
G8V0R002 12

P75E
G8V0R052 12



Future Gris
60x60 cm
Future Gris Lappato
60x60 cm

P64C
G8V42002 18

P64F
G8V42032 18



Future Blanco
100x50 cm
Future Blanco Lappato
100x50 cm

P100C
G8V21000 14

P100E
G8V21010 14



Future Blanco
37x75 cm
Future Blanco Lappato
37x75 cm

P37C
G8VAC000 24

P37F
G8VAC010 24



Future Gris
100x50 cm
Future Gris Lappato
100x50 cm

P100C
G8V21002 13

P100E
G8V21012 13



Future Gris
37x75 cm
Future Gris Lappato
37x75 cm
Future Gris Antislip Clase3/R11/A+B+C
37x75 cm

P37C
G8VAC002 24

P37F
G8VAC012 24

P37E
G8VAC052 24



Mosaico Future Blanco
30x30 cm G8V04000 Y600

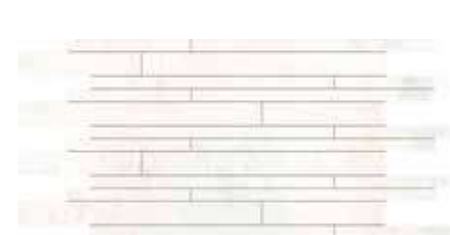

Muro Future Blanco
26x58 cm Y500
G8V0K000

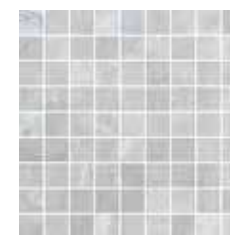

Mosaico Future Gris
30x30 cm G8V04002 Y600



Muro Future Gris
26x58 cm Y500
G8V0K002



Future Grafito 75x75 cm P75D G8V0R01J 12
 Future Grafito Lappato 75x75 cm P75F G8V0R00J 12
 Future Grafito Antislip 75x75 cm P75E G8V0R02J 12 Clase3/R11/A+B+C



Future Grafito 60x60 cm P64D G8V4201J 16
 Future Grafito Lappato 60x60 cm P64F G8V4202J 16



Future Negro 75x75 cm P75D G8V0R00K 12
 Future Negro Lappato 75x75 cm P75F G8V0R01K 12



Future Negro 60x60 cm P64D G8V4200K 18
 Future Negro Lappato 60x60 cm P64F G8V4201K 18



Future Grafito 100x50 cm P100D G8V2100J 14
 Future Grafito Lappato 100x50 cm P100E G8V2101J 14



Future Grafito 37x75 cm P37D G8VAC00J 24
 Future Grafito Lappato 37x75 cm P37F G8VAC01J 24
 Future Grafito Antislip 37x75 cm P37E G8VAC06J 24 Clase3/R11/A+B+C



Future Negro 100x50 cm P100D G8V2100K 14
 Future Negro Lappato 100x50 cm P100E G8V2101K 14

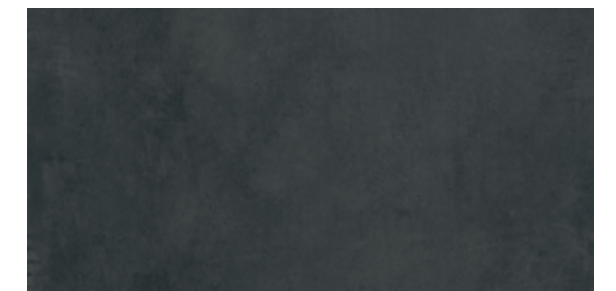

Future Negro 37x75 cm P37D G8VAC00K 24
 Future Negro Lappato 37x75 cm P37F G8VAC01K 24

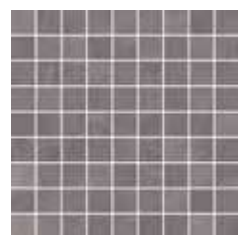

Mosaico Future Grafito 30x30 cm G8V0400J Y600



Muro Future Grafito 26x58 cm Y500 G8V0K00J

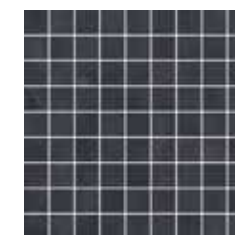

Mosaico Future Negro 30x30 cm G8V0400K Y600

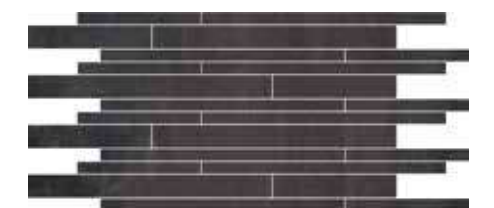

Muro Future Negro 26x58 cm Y500 G8V0K00K



Future Óxido
75x75 cm
Future Óxido Lappato
75x75 cm

P75D 12
G8V0R016
P75F 12
G8V0R006



Future Óxido
60x60 cm
Future Óxido Lappato
60x60 cm

P64D 18
G8V4200J
P64F 18
G8V42006



Future Óxido
100x50 cm
Future Óxido Lappato
100x50 cm

P100D 14
G8V21006
P100E 14
G8V21016



Future Óxido
37x75 cm
Future Óxido Lappato
37x75 cm

P37D 24
G8VAC006
P37F 24
G8VAC016

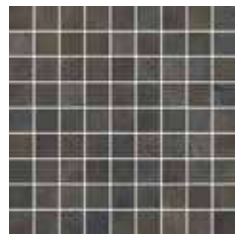

Mosaico Future Óxido
30x30 cm G8V04006 Y600



Muro Future Óxido
26x58 cm Y500 G8V0K006

Rounded edge skirting 8x50 | Rodapié ramo 8x50 \$150

Gris	G8VVP002	Beige	G8VVP001
Grafito	G8VVP00J	Oxido	G8VVP006
Negro	G8VVP00K	Cobre	G8VVP00M
Blanco	G8VVP000		

Rounded edge skirting 8x50 Lappato | Rodapié ramo 8x50 Lappato \$200

Gris	G8VVP012	Beige	G8VVP011
Grafito	G8VVP01J	Oxido	G8VVP016
Negro	G8VVP01K	Cobre	G8VVP01M
Blanco	G8VVP010		

Rounded edge skirting 8x60 | Rodapié ramo 8x60 \$280

Gris	G8V42012	Beige	G8VRQ001
Grafito	G8VRQ00J	Oxido	G8VRQ006
Negro	G8VRQ00K	Cobre	G8VRQ00M
Blanco	G8VRQ000		

Rounded edge skirting 8x60 Lappato | Rodapié ramo 8x60 Lappato \$320

Gris	G8VRQ002	Negro	G8VRQ01K
Grafito	G8VRQ01J	Beige	G8VRQ011
Oxido	G8VRQ016	Blanco	G8VRQ010
Cobre	G8VRQ01M		

Rounded edge skirting 8x75 | Rodapié ramo 8x75 \$290

Negro	G8V3E00K	Gris	G8V3E002
Beige	G8V3E001	Grafito	G8V3E00J
Oxido	G8V3E006	Cobre	G8V3E00M
Blanco	G8V3E010		

Rounded edge skirting 8x75 Lappato | Rodapié ramo 8x75 Lappato \$330

Negro	G8V3E01K	Gris	G8V3E012
Beige	G8V3E011	Grafito	G8V3E01J
Oxido	G8V3E016	Cobre	G8V3E01M
Blanco	G8V3E000		

Step 30x60 | Peldaño simple 30x60 \$500

Beige	G8V05011	Blanco	G8V05010
Cobre	G8V0501M	Grafito	G8V0501J
Gris	G8V05012	Negro	G8V0501K
Oxido	G8V05016		

Step 30x60 Lappato | Peldaño simple 30x60 Lappato \$520

Beige	G8V05001	Blanco	G8V05000
Cobre	G8V0500M	Grafito	G8V0500J
Gris	G8V05002	Negro	G8V0500K
Oxido	G8V05006		

Step 37x75 | Peldaño simple 37x75 \$560

Blanco	G8VAC040	Negro	G8VAC04K
Beige	G8VAC031	Grafito	G8VAC04J
Oxido	G8VAC046	Cobre	G8VAC04M
Gris	G8VAC032		

Step 37x75 Lappato | Peldaño simple 37x75 Lappato \$600

Beige	G8VAC051	Blanco	G8VAC020
Negro	G8VAC02K	Gris	G8VAC022
Grafito	G8VAC02J	Oxido	G8VAC026
Cobre	G8VAC02M		

Step 37x75 Antislip | Peldaño simple 37x75 Antislip \$560

Beige	G8VAC081	Gris	G8VAC092
Grafito	G8VAC07J		

Step 100x50 | Peldaño simple 100x50 \$600

Blanco	G8V21030	Negro	G8V2102K
Beige	G8V21021	Grafito	G8V2102J
Oxido	G8V21036	Cobre	G8V2102M
Gris	G8V21032		

Step 100x50 Lappato | Peldaño simple 100x50 Lappato \$610

Blanco	G8V21040	Negro	G8V2103K
Beige	G8V21031	Grafito	G8V2103J
Oxido	G8V21046	Cobre	G8V2103M
Gris	G8V21042		

Double Step 30x60 | Peldaño doble 30x60 \$650

Beige	G8V05031	Blanco	G8V05030
Cobre	G8V0503M	Grafito	G8V0503J
Gris	G8V05032	Negro	G8V0503K
Oxido	G8V05036		

Double Step 30x60 Lappato | Peldaño doble 30x60 Lappato \$670

Beige	G8V05021	Blanco	G8V05020
Cobre	G8V0502M	Grafito	G8V0502J
Gris	G8V05022	Negro	G8V0502K
Oxido	G8V05026		

Double Step 37x75 | Peldaño doble 37x75 \$690

Blanco	G8VAC050	Grafito	G8VAC05J
Negro	G8VAC05K	Gris	G8VAC042
Beige	G8VAC041	Cobre	G8VAC05M
Oxido	G8VAC056		

Double Step 37x75 Lappato | Peldaño doble 37x75 Lappato \$710

Blanco	G8VAC030	Negro	G8VAC03K
Beige	G8VAC021	Grafito	G8VAC03J
Oxido	G8VAC036	Cobre	G8VAC03M

Double Step 37x75 Antislip | Peldaño doble 37x75 Antislip \$690

Beige	G8VAC061	Gris	G8VAC082
Grafito	G8VAC09J		

Double Step 100x50 | Peldaño doble 100x50 \$720

Blanco	G8V21050	Negro	G8V2104K
Beige	G8V21041	Grafito	G8V2104J
Oxido	G8V21056	Cobre	G8V21023
Gris	G8V21052		

Double Step 100x50 Lappato | Peldaño doble 100x50 Lappato \$730

Blanco	G8V21060	Negro	G8V2105K
Beige	G8V21051	Grafito	G8V2105J
Oxido	G8V21066	Cobre	G8V2102M
Gris	G8V21062		

PACKING LIST

formato/size	artículo/item	pzs-cj/pcs-box	m²/cj/box	kg/cj/box	cj/box/epl	m²/epl	kg/epl
100x50/40"x20"	Base/Lappato	2	1,00	23,60	28	28,00	683,80
75x75/30"x30"	Base/Lappato/Antislip	2	1,13	24,62	42	47,46	1057,04
37x75/15"x30"	Base/Lappato/Antislip	4	1,13	24,24	48	54,24	1186,52
60x60/24"x24"	Base/Lappato	3	1,08	22,53	40	43,20	924,20
26x58/10"x24"	Muro	5	0,75	15,10	30	22,50	476,00
30x30/12"x12"	Mosaico	11	1,00	20,46	36	36,00	759,56
8x50/3"x20"	Rodapié Base/Lappato	10	0,40	9,60	120	48,00	1175,00
8x60/3"x24"	Rodapié Base/Lappato	10	0,48	11,30	80	38,40	943,00
8x75/3"x30"	Rodapié Base/Lappato	10	0,60	12,90	80	48,00	1055,00
30x60/12"x24"	Peldaño Base/Lappato	6	1,08	20,58			
37x75/15"x30"	Peldaño Base/Lappato/Antislip	4	1,11	24,24		Please ask for information / Consulte información	
100x50/40"x20"	Peldaño Base/Lappato	2	1,00	25,20		Please ask for information / Consulte información	
30x60/12"x24"	Peldaño Doble Base/Lappato	2	0,36	13,28		Please ask for information / Consulte información	
37x75/15"x30"	Peldaño Doble Base/Lappato/Antislip	2	0,56	12,12		Please ask for information / Consulte información	
100x50/40"x20"	Peldaño Doble Base/Lappato	2	1,00	28,34		Please ask for information / Consulte información	

FUTURE



WALL TILES | FUTURE BLANCO 30X90, FUTURE CONCEPT BLANCO 30X90, FUTURE
CONCEPT ÓXIDO 30X90, PERFIL ACERO PLATA 1,5X90
FLOOR TILES | FUTURE ÓXIDO 75X75



30x90
12"x36" **FUTURE**

WHITE BODY WALL TILES

REVESTIMIENTO PASTA BLANCA

FAÏENCE PÂTE BLANCHE

WEISSSCHERBIGE WANDFLIESEN

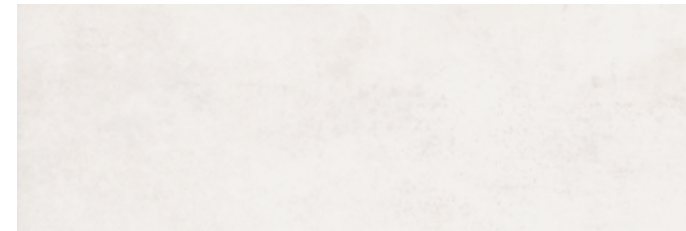

Future Blanco
30x90 cm

R90D
K8VPG000 14



Future Beige
30x90 cm

R90D
K8VPG001 14



Future Concept Blanco
30x90 cm

R90F
K8VPG010 9



Future Concept Beige
30x90 cm

R90F
K8VPG011 8



Future Concept Óxido
30x90 cm

R90F
K8VPG006 8



Future Concept Cobre
30x90 cm

R90F
K8VPG003 8



Perfil Acero Plata
1,5x90 cm

S330
K432L00L



Perfil Acero Bronce
1,5x90 cm

S330
K432L00M



Malla Acero Plata
30,5x32,5 cm K8V3J00L \$540



Malla Acero Bronce
30,5x32,5 cm K8V3J00M \$540

PACKING LIST

formato/size	artículo/item	pzs-cj/pcs-box	m²/cj/box	kg/cj/box	cj/box/epl	m²/epl	kg/epl
30x90/12"x36"	Base/Concept	4	1,08	18,84	51	55,08	983,84
30x90/12"x36"	Decor	2	0,54	9,80	44	23,76	454,20
1,5x90/0,8"x36"	Perfil	6	0,08	0,90	336	27,22	325,40
30,5x32,5/14"x14"	Malla	11	1,09	6,05	72	78,51	458,60

WALL TILES | FUTURE BLANCO 30X90, FUTURE CONCEPT BLANCO 30X90,
FUTURE CONCEPT ÓXIDO 30X90



WALL TILES | FUTURE BEIGE 30X90, LISTELO SASHA 4,8X30, DECOR NOOR BEIGE 30X90



WHITE BODY WALL TILES

REVESTIMIENTO PASTA BLANCA

FAIENCE PÂTE BLANCHE

WEISSSCHERBIGE WANDFLIESEN



Future Beige
30x90 cm R90D K8VPG001 14



Listelo Sasha
4,8x30 cm S460 GJUH600D



**** Decor Noor Beige (Set de 2 piezas)** S600
30X90 cm K8VPG021



Zócalo Sasha
12,5x30 cm S570 GJUTB00D



WALL TILES | FUTURE CONCEPT COBRE 25X70 | FUTURE COBRE 25X70,
 FUTURE BEIGE 25X70
 FLOOR TILES | FUTURE COBRE 50X50

FUTURE 50X50 20" X 20"

COLOURED BODY PORCELAIN FLOOR TILES | PAVIMENTO PORCELÁNICO COLOREADO | GRÉS CÉRAME COLORE | DURCHGEFÄRBTE FEINSTEINZEUGBODENFLIESEN



Future Blanco P50C
50x50cm G8V13010



Future Gris P50D
50x50cm G8V13012



Future Óxido P50D
50x50cm G8V13026



Future Beige P50C
50x50cm G8V13001



Future Cobre P50D
50x50cm G8V1300M

Rounded edge skirting 8x50 | Rodapié romano 8x50 S150
 Beige G8VVP021 Blanco G8VVP020
 Cobre G8VVP022 Gris G8VVP022
 Óxido G8VVP026



25x70 10" x 28" FUTURE

WHITE BODY WALL TILES | REVESTIMIENTO PASTA BLANCA | FAÏENCE PÂTE BLANCHE | WEISSSCHERBIGE WANDFLIESEN



Future Blanco R27D
25x70 cm K8VZA000 16



Future Gris R27D
25x70 cm K8VZA002 12



Future Óxido R27D
25x70 cm K8VZA006 12



Future Concept Óxido R27G
25x70 cm K8VZA016 3



Future Beige R27D
25x70 cm K8VZA001 12



Future Cobre R27D
25x70 cm K8VZA003 12



Future Concept Cobre R27G
25x70 cm K8VZA013 3



Perfil Acero Plata S300
1,5x70 cm KZD2800L



Perfil Acero Bronce S300
1,5x70 cm KZD2800M



Malla Acero Plata
30,5x32,5 cm K8V3J00L S540



Malla Acero Bronce
30,5x32,5 cm K8V3J00M S540

PACKING LIST

formato/size	artículo/item	pzs-cj/pcs-box	m²/ml/cj/box	kg/cj/box	cj/box/epl	m²/ml/epl	kg/epl
25x70/10" x 28"	Base/ Concept	7	1,23	21,35	42	51,66	919,70
50x50/20" x 20"	Base	4	1,00	20,52	36	36,00	761,72
1,5x70/0,8" x 28"	Perfil	6	0,06	0,72	400	25,20	311,00
30,5x32,5/14" x 14"	Malla	11	1,09	6,05	72	78,51	458,60
4,8x30/1,9" x 12"	Listelo	11	0,16	3,30	110	17,42	386,00
12,5x30/4,9" x 12"	Zócalo	6	0,22	4,80	110	24,75	551,00
8x50/3" x 20"	Rodapié	10	0,40	9,60	120	48	1175

JAZZ

FLOOR TILES | JAZZ GREIGE OUTDOOR 60X60



Jazz Blanco 60x60 cm P64C G1842020 19



Jazz Gris 60x60 cm P64C G1842022 19



Jazz Greige 60x60 cm P64C G1842030 19



Jazz Grafito 60x60 cm P64D G184202J 19



Jazz Blanco Outdoor 60x60 cm P64D G1842000 14
Clase3/R11/A+B+C



Jazz Gris Outdoor 60x60 cm P64D G1842002 14
Clase3/R11/A+B+C



Jazz Greige Outdoor 60x60 cm P64D G1842050 11
Clase3/R11/A+B+C



Jazz Grafito Outdoor 60x60 cm P64E G184200J 14
Clase3/R11/A+B+C



Jazz Blanco 30x60 cm P34C G1842064 36



Jazz Gris 30x60 cm P34C G1842061 38



Jazz Greige 30x60 cm P34C G1842065 38



Jazz Grafito 30x60 cm P34D G1842060 38



Mosaico Jazz Blanco 30x30 cm G1842109 Y500

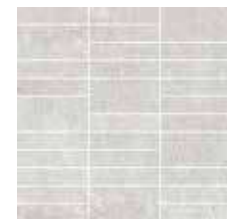

Mosaico Jazz Gris 30x30 cm G1842106 Y500

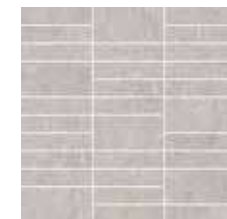

Mosaico Jazz Greige 30x30 cm G1842110 Y500

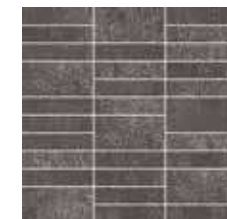

Mosaico Jazz Grafito 30x30 cm G1842107 Y500

PACKING LIST

formato/size	artículo/item	pzs-cj/pcs-box	m²cj/box	kg/cj/box	cj/box/epl	m²/epl	kg/epl
60x60/24" x 24"	Base/ Outdoor	3	1,08	22,53	40	43,20	924,20
30x60/12" x 24"	Base	6	1,08	22,32	40	43,20	915,80
30x30/12" x 12"	Mosaico	11	1,00	20,46	36	36,00	759,56
8x60/3" x 24"	Rodapié	10	0,48	11,30	80	38,40	943,00
30x60/12" x 24"	Peldaño	6	1,08	20,58	Please ask for information / Consulte información		
30x60/12" x 24"	Peldaño Doble	2	0,36	13,28	Please ask for information / Consulte información		

Rounded edge skirting 8x60 | Rodapié romo 8x60 S280
Gris G1842096 Grafito G1842097
Blanco G1842099 Greige G1842100

Step 30x60 | Peldaño simple 30x60 S500
Gris G1842076 Grafito G1842077
Blanco G1842079 Greige G1842080

Double Step 30x60 | Peldaño doble 30x60 S650
Gris G1842084 Grafito G1842087
Blanco G1842089 Greige G1842090

KURSAL



WALL TILES | KURSAL GRIS 100X50
FLOOR TILES | KURSAL GRIS 100X50



Kursal Blanco
100x50 cm

P100C
GKU27000



Kursal Gris
100x50 cm

P100C
GKU27002



Kursal Beige
100x50 cm

P100C
GKU27001



Kursal Moka
100x50 cm

P100D
GKU2700D



Kursal Blanco
60x60 cm

P64C
GKU42000



Kursal Gris
60x60 cm

P64C
GKU42012



Kursal Beige
60x60 cm

P64C
GKU42001



Kursal Moka
60x60 cm

P64D
GKU4202D



Kursal Blanco
30x60 cm

P34C
GKU05000



Kursal Gris
30x60 cm

P34C
GKU05002



Kursal Beige
30x60 cm

P34C
GKU05001



Kursal Moka
30x60 cm

P34D
GKU0500D



Kursal Óxido
100x50 cm

P100D
GKU27006



Kursal Óxido
60x60 cm

P64D
GKU42026



Kursal Óxido
30x60 cm

P34D
GKU05006

	Rounded edge skirting 8x60 Rodapié romo 8x60 S280					Step 30x60 Peldaño simple 30x60 S500					Double Step 30x60 Peldaño doble 30x60 S650			
	Blanco	GKURQ000	Grís	GKURQ002		Blanco	GKU05020	Grís	GKU05022		Blanco	GKU05010	Grís	GKU05012
	Oxido	GKURQ006	Beige	GKURQ001		Oxido	GKU05024	Beige	GKU05021		Oxido	GKU05016	Beige	GKU05011
	Moka	GKURQ00D			Moka	GKU0502D			Moka	GKU0501D				
					Step 100x50 Peldaño simple 100x50 S600				Double Step 100x50 Peldaño doble 100x50 S720					
				Beige	GKU27041	Moka	GKU2704D	Beige	GKU27051	Moka	GKU2705D			
				Oxido	GKU27046	Grís	GKU27042	Oxido	GKU27056	Grís	GKU27052			
				Blanco	GKU27040			Blanco	GKU27050					

PACKING LIST

formato/size	artículo/item	pzs-cj/pcs-box	m²cj/box	kg/cj/box	cj/box/epl	m²/epl	kg/epl
100x50/40" x20"	Base	2	1,00	23,60	28	28,00	683,80
60x60/24" x24"	Base	3	1,08	22,53	40	43,20	924,20
30x60/12" x24"	Base	6	1,08	22,32	40	43,20	915,80
8x60/3" x24"	Rodapié	10	0,48	11,50	80	38,40	943,00
30x60/12" x24"	Peldaño	6	1,08	20,58	Please ask for information / Consulte información		
30x60/12" x24"	Peldaño Doble	2	0,36	13,28	Please ask for information / Consulte información		
100x50/40" x20"	Peldaño	2	1,00	25,20	Please ask for information / Consulte información		
100x50/40" x20"	Peldaño Doble	2	1,00	28,34	Please ask for information / Consulte información		





WALL TILES | KURSAL ÓXIDO 25X50, KURSAL BLANCO 25X50, LISTELO FOLK GRIS 12X50, MURO KURSAL ÓXIDO 20X40
FLOOR TILES | KURSAL ÓXIDO 50X50



25x50
10" x 20" **KURSAL**

WHITE BODY WALL TILES | REVESTIMIENTO PASTA BLANCA | FAÏENCE PÂTE BLANCHE | WEISSSCHERBIGE WANDFLIESEN



Kursal Blanco 25x50 cm R25C
KKU25000



Kursal Beige 25x50 cm R25C
KKU25001



Kursal Gris 25x50 cm R25C
KKU25002



Kursal Moka 25x50 cm R25D
KKU1900D



Kursal Óxido 25x50 cm R25D
KKU19006



Listelo Folk Gris 12x50 cm S440
KKUOV002



Listelo Folk Moka 12x50 cm S440
KKUOV00D



50X50
20" X 20" **KURSAL**

COLOURED BODY PORCELAIN FLOOR TILES | PAVIMENTO PORCELÁNICO COLOREADO | GRÈS CÉRAME COLORE | DURCHGEFÄRBTE FEINSTEINZEUGBODENFLIESEN



Kursal Blanco P50D 50x50cm GKU13000



Kursal Gris P50D 50x50cm GKU13022



Kursal Beige P50D 50x50cm GKU13011



Kursal Moka P50D 50x50cm GKU1300D



Kursal Óxido P50D 50x50cm GKU13026



PACKING LIST

formato/size	artículo/item	pzs-cj/pcs-box	m²cj/box	kg/cj/box	cj/box/epl	m²/epl	kg/epl
25x50/10" x 20"	Base	11	1,38	21,78	36	49,68	807,08
50x50/20" x 20"	Base	4	1,00	20,52	36	36,00	761,72
12x50/4,7" x 20"	Listelo	7	0,42	7,70	78	32,75	623,60
8x50/3" x 20"	Rodapié	10	0,40	9,60	120	48,00	1175,00

LAVA

MARIA GALLAND
PARIS

MARIA GALLAND
PARIS
LES
ESSENCES

MARIA GALLAND
PARIS

WALL TILES | LAVA GRIS OUTDOOR 60X60
FLOOR TILES | LAVA GRIS OUTDOOR 60X60



Lava Blanco
100x50 cm

P100D
GL421010 15



Lava Gris
100x50 cm

P100D
GL421012 15

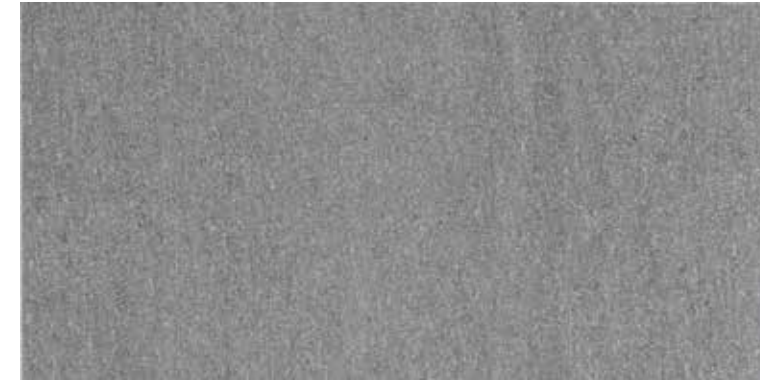

Lava Grafito
100x50 cm

P100F
GL42101J 15



Lava Negro
100x50 cm

P100F
GL42101K 15

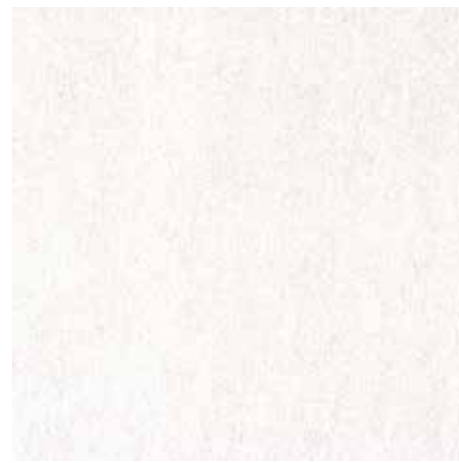

Lava Blanco
60x60 cm

P64D
GL442000 11



Lava Gris
60x60 cm

P64D
GL442002 16

Lava Gris Outdoor
Clase3/R11/A+B+C
60x60 cm

P64D
GL442022 16

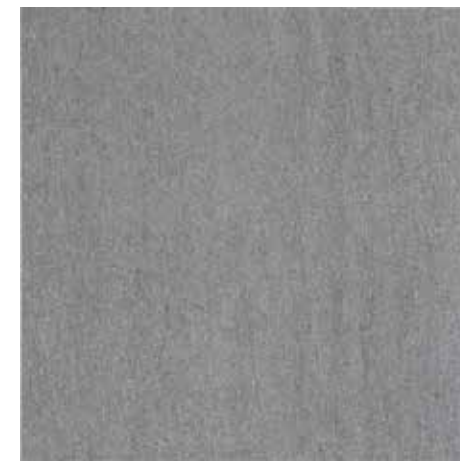

Lava Grafito
60x60 cm

P64E
GL44200J 16



Lava Negro
60x60 cm

P64E
GL44200K 16



Lava Blanco
30x60 cm

P34D
GL405030 22



Lava Gris
30x60 cm

P34D
GL405022 32

Lava Gris Outdoor
Clase3/R11/A+B+C
30x60 cm

P34D
GL405012 32

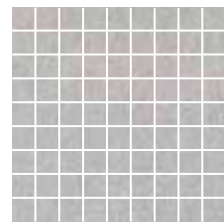

Mosaico Lava Gris
30x30 cm GL404002
Y600



Lava Grafito
30x60 cm

P34E
GL40501J 32

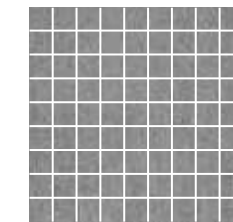

Mosaico Lava Grafito
30x30 cm GL40400J
Y600



Lava Negro
30x60 cm

P34E
GL40502K 32

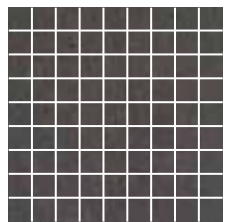

Mosaico Lava Negro
30x30 cm GL40400K
Y600

PACKING LIST

formato/size	artículo/item	pzs-cj/pcs-box	m²cj/box	kg/cj/box	cj/box/epl	m²/epl	kg/epl
100x50/40"x20"	Base	2	1,00	23,60	28	28,00	683,80
60x60/24"x24"	Base / Outdoor	3	1,08	22,53	40	43,20	924,20
30x60/12"x24"	Base / Outdoor	6	1,08	22,32	40	43,20	915,80
30x30/12"x12"	Mosaico	11	1,00	20,46	36	36,00	759,56
8x60/3"x24"	Rodapié	10	0,48	11,30	80	38,40	943,00
30x60/12"x24"	Peldaño Base / Outdoor	6	1,08	20,58	Please ask for information / Consulte información		
30x60/12"x24"	Peldaño Doble Base / Outdoor	2	0,36	13,28	Please ask for information / Consulte información		
100x50/40"x20"	Peldaño	2	1,00	25,20	Please ask for information / Consulte información		
100x50/40"x20"	Peldaño Doble	2	1,00	28,34	Please ask for information / Consulte información		

Rounded edge skirting 8x60 | Rodapié romo 8x60 S280
Blanco GL4RQ000 Gris GL4RQ002
Grafito GL4RQ00J Negro GL4RQ00K

Step 30x60 | Peldaño simple 30x60 S500
Blanco GL405040 Gris GL40504K
Grafito GL40504J Negro GL40504K

Step 30x60 Outdoor |
Peldaño simple 30x60 Outdoor S500
Gris GL405052

Step 100x50 | Peldaño simple 100x50 S600
Blanco GL421020 Gris GL421022
Grafito GL42102J Negro GL42102K

Double Step 30x60 | Peldaño doble 30x60 S650
Blanco GL405070 Gris GL40507K
Grafito GL40507J Negro GL40507K

Double Step 30x60 Outdoor |
Peldaño doble 30x60 Outdoor S650
Gris GL405082

Double Step 100x50 | Peldaño doble 100x50 S720
Blanco GL421040 Gris GL421042
Grafito GL42104J Negro GL42104K

LIVING



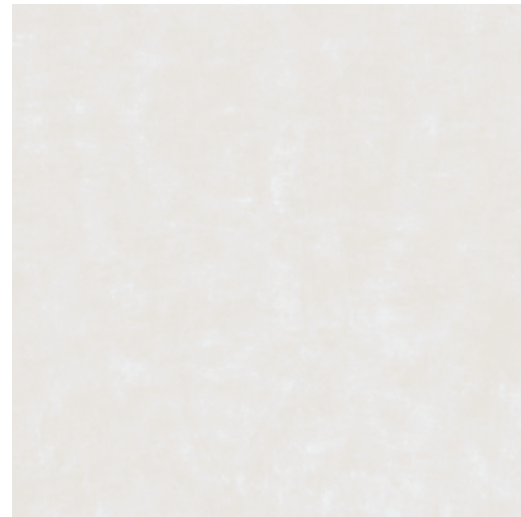

Living Blanco 75x75 cm P75C GDH0R000

Living Blanco Lappato 75x75 cm P75F GDH0R010



Living Gris 75x75 cm P75C GDH0R002

Living Gris Lappato 75x75 cm P75F GDH0R012

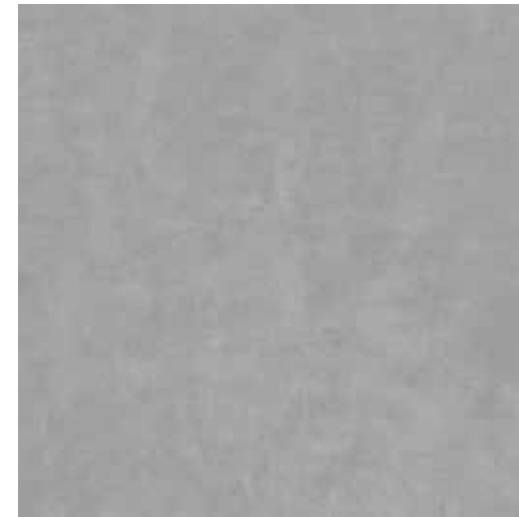

Living Grafito 75x75 cm P75D GDH0R00J

Living Grafito Lappato 75x75 cm P75F GDH0R01J

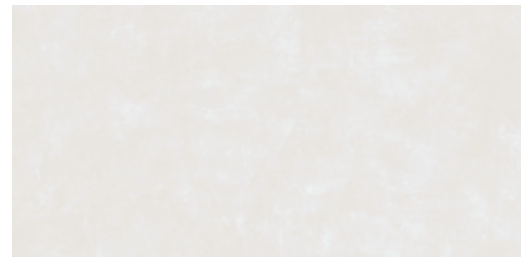

Living Blanco 37x75 cm P37C GDHAC000

Living Blanco Lappato 37x75 cm P37F GDHAC010



Living Gris 37x75 cm P37C GDHAC002

Living Gris Lappato 37x75 cm P37F GDHAC012



Living Grafito 37x75 cm P37D GDHAC00J

Living Grafito Lappato 37x75 cm P37F GDHAC01J



Living Blanco 60x60 cm P64C GDH42000

Living Blanco Lappato 60x60 cm P64F GDH42020



Living Gris 60x60 cm P64C GDH42002

Living Gris Lappato 60x60 cm P64F GDH42022



Living Grafito 60x60 cm P64D GDH4200J

Living Grafito Lappato 60x60 cm P64F GDH4202J



Living Negro 60x60 cm P64D GDH4200K

Living Negro Lappato 60x60 cm P64F GDH4201K

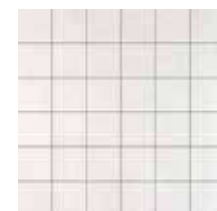

Mosaico Living Blanco 30x30 cm GDH04000 Y500



Mosaico Living Gris 30x30 cm GDH04002 Y500

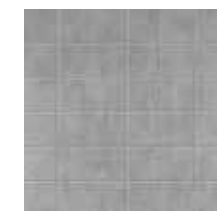

Mosaico Living Grafito 30x30 cm GDH0400J Y500

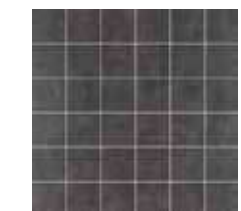

Mosaico Living Negro 30x30 cm GDH0400K Y500

LIVING 75x75 | 60x60 | 37x75

30" x 30" | 24" x 24" | 15" x 30"



COLOURED BODY PORCELAIN FLOOR TILES | PAVIMENTO PORCELÁNICO COLOREADO
GRÉS CÉRAME COLORE | DURCHGEFÄRBTE FEINSTEINZEUGBODENFLIESEN

Natural: Clase 2 | R9



Living Beige 75x75 cm P75C GDHOR001 4
Living Beige Lappato 75x75 cm P75F GDHOR011 4

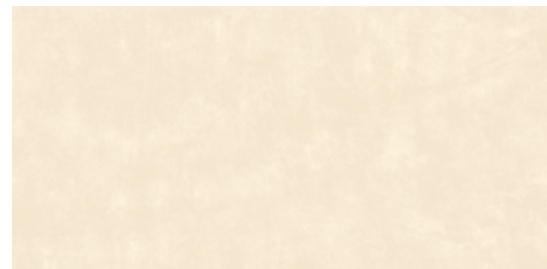

Living Beige 37x75 cm P37C GDHAC001 8
Living Beige Lappato 37x75 cm P37F GDHAC011 8



Living Beige 60x60 cm P64C GDH42001
Living Beige Lappato 60x60 cm P64F GDH42021

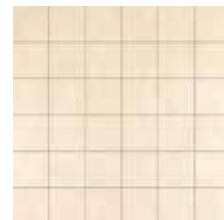

Mosaico Living Beige 30x30 cm GDH04001 Y500



Living Marrón 60x60 cm P64D GDH42003
Living Marrón Lappato 60x60 cm P64F GDH42023



Mosaico Living Marrón 30x30 cm GDH04003 Y500



FLOOR TILES | LIVING BEIGE 75X75

Rounded edge skirting 8x60 Rodapié romo 8x60 S280				Rounded edge skirting 8x60 Lappato Rodapié romo 8x60 Lappato S320				Rounded edge skirting 8x75 Rodapié romo 8x75 S290			
Blanco	GDHRQ100	Beige	GDHRQ101	Blanco	GDHRQ110	Beige	GDHRQ111	Blanco	GDH3E000	Beige	GDH3E001
Marrón	GDHRQ103	Gris	GDHRQ112	Marrón	GDHRQ113	Gris	GDHRQ122	Gris	GDH3E002	Grafito	GDH3E00J
Grafito	GDHRQ102	Negro	GDHRQ10K	Grafito	GDHRQ00J	Negro	GDHRQ11K				

PACKING LIST

formato/size	artículo/item	pzs-cj/pcs-box	m²cj/box	kg/cj/box	cj/box/epl	m²/epl	kg/epl
75x75/30" x 30"	Base / Lappato	2	1,13	24,62	42	47,46	1057,04
37x75/15" x 30"	Base / Lappato	4	1,13	24,24	48	54,24	1186,52
60x60/24" x 24"	Base / Lappato	3	1,08	22,53	40	43,20	924,20
30x30/12" x 12"	Mosaico	11	1,00	20,46	36	36,00	759,56
8x60/3" x 24"	Rodapié Base / Lappato	10	0,48	11,30	80	38,40	943,00
8x75/3" x 30"	Rodapié Base / Lappato	10	0,60	12,90	80	48,00	1055,00



25x70
10" x 28" **LIVING**

WHITE BODY WALL TILES | REVESTIMIENTO PASTA BLANCA | FAÏENCE PÂTE BLANCHE | WEISSSCHERBIGE WANDFLIESEN



Living Blanco 25x70 cm R27C KDHZA000



Living Beige 25x70 cm R27C KDHZA001



Líneas Living Negro 25x70 cm R27F KDHZA01K



Listelo Xilo Marrón 7,8x70 cm S490 KDHMN003



Listelo Xilo Negro 7,8x70 cm S490 KDHMN00K

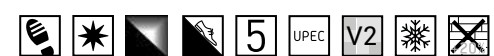

50X50
20" X 20" **LIVING**

COLOURED BODY PORCELAIN FLOOR TILES | PAVIMENTO PORCELÁNICO COLOREADO
GRÉS CÉRAME COLOREÉ | DURCHGEFÄRBTE FEINSTEINZEUGBODENFLIESEN

Natural: Clase I | R9



Living Blanco CI P50D 50x50cm GDH13000



Living Gris CI P50D 50x50cm GDH13002



Living Grafito CI P50D 50x50cm GDH1300J



Living Negro CI P50D 50x50cm GDH1300K



Living Beige CI P50D 50x50cm GDH1300I



PACKING LIST

formato/size	artículo/item	pzs.-cj./pcs.-box	m ² /cj./box	kg/cj./box	cj./box/epI	m ² /epI	kg/epI
25x70/10" x 28"	Base / Líneas	7	1,23	21,35	42	51,66	919,70
50x50/20" x 20"	Base	4	1,00	20,52	36	36,00	761,72
7,8x70/3" x 28"	Listelo	4	0,22	4,32	80	17,47	368,60
8x50/3" x 20"	Rodapié	10	0,40	9,60	120	48,00	1175,00

WALL TILES | LIVING BLANCO 25X70, LINEAS LIVING NEGRO 25X70
FLOOR TILES | LIVING NEGRO 37X75

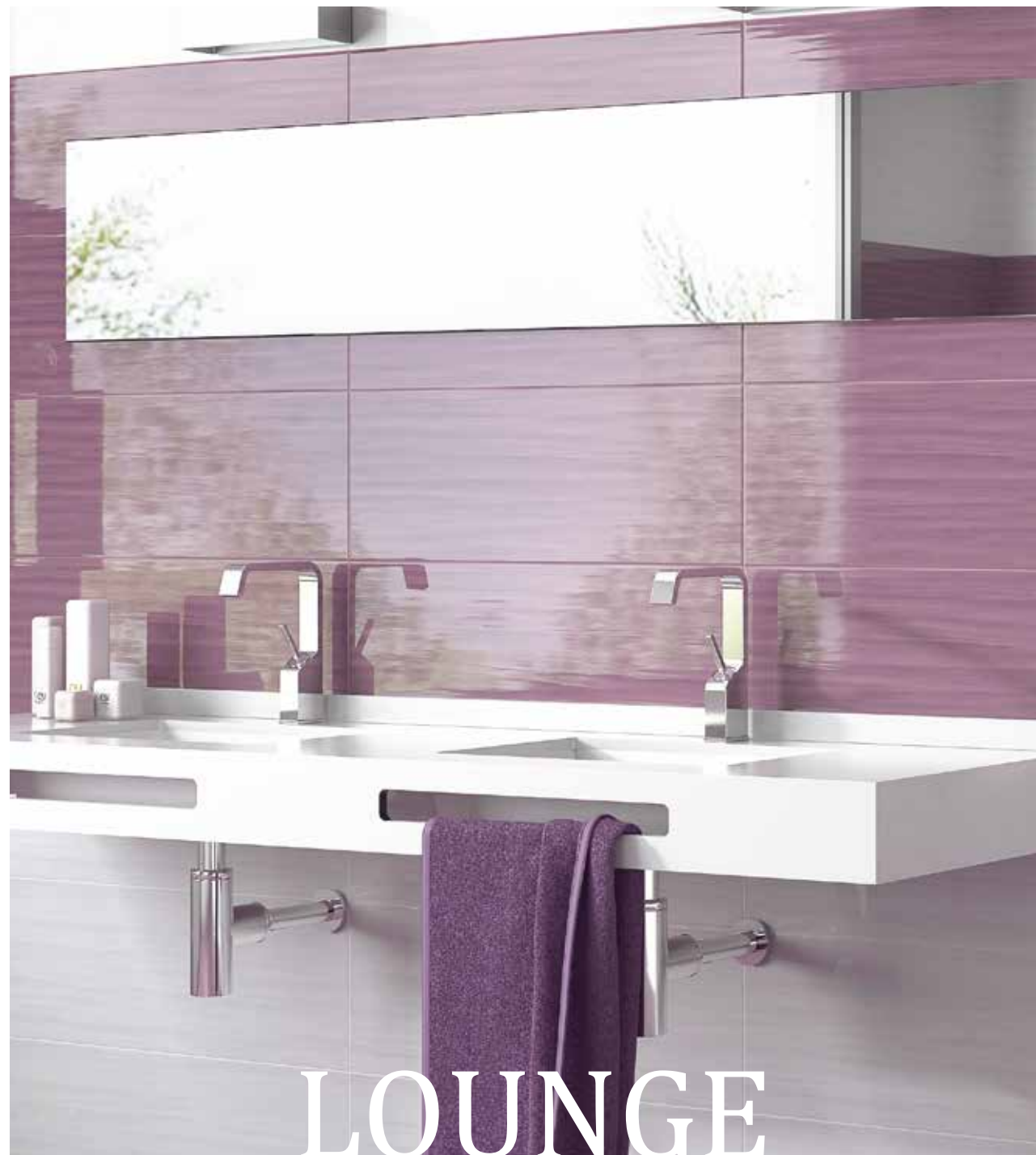

LOUNGE

WALL TILES | LOUNGE BLANCO 25X70, LOUNGE MALVA 25X70

PACKING LIST

formato/size	artículo/item	pzs-cj/pcs-box	m²cj/box	kg/cj/box	cj/box/epl	m²/epl	kg/epl
25x70/10"x28"	Base / Concept	7	1,23	21,35	42	51,66	919,70
30x30/12"x12"	Malla	9	0,81	15,57	42	34,00	676,94
7,8x70/3"x28"	Listelo	6	0,33	6,48	80	26,21	541,40
50x50/20"x20"	Base	4	1,00	20,52	36	36,00	761,72
8x50/3"x20"	Rodapié	10	0,40	9,60	120	48,00	1175,00



WALL TILES | LOUNGE BLANCO 25X70, LOUNGE MALVA 25X70,
LOUNGE CONCEPT MALVA 25X70
FLOOR TILES | MATCH PURPURA 50X50

LOUNGE

25x70
10" x 28"



WHITE BODY WALL TILES | REVESTIMIENTO PASTA BLANCA | FAÏENCE PÂTE BLANCHE | WEISSSCHERBIGE WANDFLIESEN



Lounge Blanco R27C
25x70 cm K33ZA000



Listelo Motion Azul S480
7,8x70 cm K33MN009



Lounge Azul R27D
25x70 cm K33ZA019

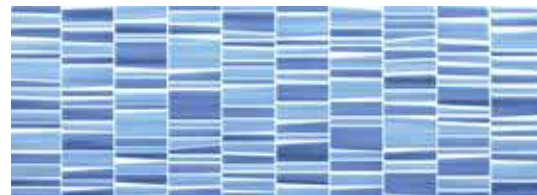

Lounge Concept Azul R27G
25x70 cm K33ZA009

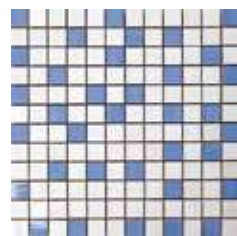

Malla Lounge Azul
30x30 cm K3304009 S550



Lounge Blanco R27C
25x70 cm K33ZA000



Listelo Motion Malva S480
7,8x70 cm K33MN00F



Lounge Malva R27D
25x70 cm K33ZA01F

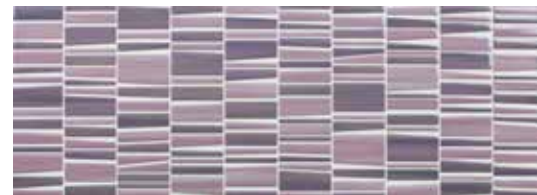

Lounge Concept Malva R27G
25x70 cm K33ZA00F

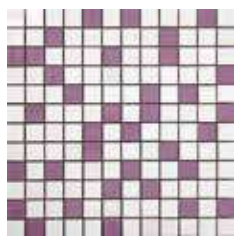

Malla Lounge Malva
30x30 cm K330400F S550



Lounge Blanco R27C
25x70 cm K33ZA000



Listelo Motion Gris S480
7,8x70 cm K33MN002

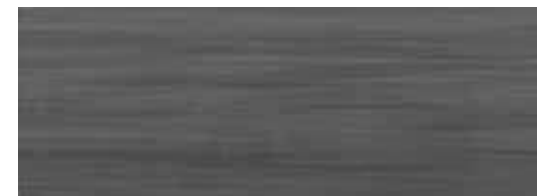

Lounge Gris R27D
25x70 cm K33ZA012



Lounge Concept Gris R27G
25x70 cm K33ZA002

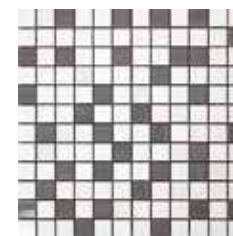

Malla Lounge Gris
30x30 cm K3304002 S550



Lounge Crema R27C
25x70 cm K33ZA001



Listelo Motion Marrón S480
7,8x70 cm K33MN003



Listelo Motion Rojo S480
7,8x70 cm K33MN006

MATCH

50X50
20" X 20"

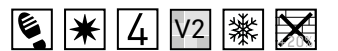

GLAZED PORCELAIN FLOOR TILES | PAVIMENTO PORCELÁNICO ESMALTADO | GRÈS CÉRAME ÉMAILLE | GLASIERTE FEINSTEINZEUG BODENFLIESEN



Match Cobalto P50D
50x50cm GQ413030



Match Púrpura P50D
50x50cm GQ41300F



Match Antrazita P50D
50x50cm GQ41300K



Match Negro P50D
50x50cm GQ41301K



Match Marrón P50D
50x50cm GQ413023

Rounded edge skirting 8x50 | Rodapié romo 8x50 S150
Cobalto GQ4VP000 Púrpura GQ4VP00F
Antrazita GQ4VP00K Negro GQ4VP01K
Marrón GQ4VP013

MADAGASCAR



MADAGASCAR

75x75 | 37x75
30" x30" | 15" x30"



COLOURED BODY PORCELAIN FLOOR TILES | PAVIMENTO PORCELÁNICO COLOREADO | GRÉS CÉRAMÉ COLORÉ | DURCHGEFÄRBTE FEINSTEINZEUGBODENFLIESEN *
GLAZED PORCELAIN FLOOR TILES | PAVIMENTO PORCELÁNICO ESMALTADO | GRÉS CÉRAMÉ EMAILÉ | GLASIERTE FEINSTEINZEUG BODENFLIESEN **



Madagascar White
75x75 cm P75C GGW0R000 14



Madagascar Grey
75x75 cm P75C GGW0R002 14



Madagascar Cream
75x75 cm P75C GGW0R001 14



Madagascar White
37x75 cm P37C GGWAC000 28



Madagascar Grey
37x75 cm P37C GGWAC002 28



Madagascar Cream
37x75 cm P37C GGWAC001 28



Muro Madagascar White
26x58 cm Y500 GGW0K000



Muro Madagascar Grey
26x58 cm Y500 GGW0K002



Muro Madagascar Cream
26x58 cm Y500 GGW0K001



Mosaico Madagascar Cream
30x30 cm GGW04001 Y300



Mosaico Madagascar White
30x30 cm GGW04000 Y300



Mosaico Madagascar Grey
30x30 cm GGW04002 Y300

* Grey
** White / Cream



PACKING LIST

formato/size	artículo/item	pzs.-cjs./pcs.-box	m ² /cjs./box	kg/cjs./box	cjs./box/epl	m ² /epi	kg/epi
75x75/30" x30"	Base	2	1,13	24,62	42	47,46	1057,04
37x75/15" x30"	Base	4	1,13	24,24	48	54,24	1186,52
26x58/10" x24"	Muro	5	0,75	15,10	30	22,50	476,00
30x30/12" x12"	Mosaico	11	1,00	20,46	36	36,00	759,56
8x75/3" x30"	Rodapié	10	0,60	12,90	80	48,00	1055,00
37x75/15" x30"	Peldaño	4	1,11	24,24	Please ask for information / Consulte información		
37x75/15" x30"	Peldaño Doble	2	0,56	12,12	Please ask for information / Consulte información		

MADEIRA



NATURAL

ANTISLIP

LAPPATO

	Crema P125D GMD44001		Crema P125F GMD44261
	Roble P125D GMD44003		Roble C3 P125E GMD44101
	Titanium P125D GMD44023		Titanium C3 P125E GMD4407T
	Ceniza P125D GMD44012		Titanium P125F GMD4411T
	Toscana P125D GMD44013		Toscana P125F GMD4412T
	Blanco P125D GMD44000		Blanco P125F GMD44060
	Gris P125D GMD44002		Gris P125F GMD44122
	Grafito P125D GMD4400J		Grafito C3 P125E GMD4403J
	Negro P125D GMD4400K		Negro P125F GMD4404K

Rounded edge skirting 8x50 | Rodapié romano 8x50 S150

Crema	GMDVP001	Blanco	GMDVP000
Roble	GMDVP011	Gris	GMDVP012
Titanium	GMDVP00T	Grafito	GMDVP00J
Ceniza	GMDVP002	Negro	GMDVP00K
Toscana	GMDVP01T		

Rounded edge skirting 8x50 Lappato | Rodapié romano 8x50 Lappato S200

Crema	GMDVP041	Blanco	GMDVP010
Roble	GMDVP031	Gris	GMDVP032
Titanium	GMDVP02T	Negro	GMDVP01K
Toscana	GMDVP03T		

Step 100x24,8 | Peldaño simple 100x24,8 S600

Crema	GMD44031	Blanco	GMD44020
Roble	GMD44021	Gris	GMD44042
Titanium	GMD4400T	Grafito	GMD4401J
Ceniza	GMD44052	Negro	GMD4401K
Toscana	GMD4405T		

Step 100x24,8 Lappato | Peldaño simple 100x24,8 Lappato S610

Crema	GMDVP051	Blanco	GMDVP020
Roble	GMD44211	Gris	GMD44132
Titanium	GMD4413T	Negro	GMD4405K
Toscana	GMD4414T		

Step 100x24,8 C-3 | Peldaño simple 100x24,8 C-3 S600

Roble	GMD44191	Titanium	GMD4413T
Grafito	GMD4404J		

Double Step 100x24,8 | Peldaño doble 100x24,8 S720

Crema	GMD44071	Blanco	GMD44040
Roble	GMD44061	Gris	GMD44072
Titanium	GMD4402T	Grafito	GMD4402J
Ceniza	GMD44082	Negro	GMD4402K
Toscana	GMD4406T		

Double Step 100x24,8 Lappato | Peldaño doble 100x24,8 Lappato S730

Crema	GMD44281	Blanco	GMD44070
Roble	GMD44221	Gris	GMD44142
Titanium	GMD4415T	Negro	GMD4406K
Toscana	GMD4416T		

Double Step 100x24,8 C-3 | Peldaño doble 100x24,8 C-3 S720

Roble	GMD44131	Titanium	GMD4421T
Grafito	GMD4405J		

Natural: Clase I | R9
Antislip: Clase 3 | R11 | A+B+C



Madeira Crema
100x24,8 cm
P125D
GMD44001 26

Madeira Crema Lappato
100x24,8 cm
P125F
GMD44261 26



Madeira Roble
100x24,8 cm
P125D
GMD44003 30

Madeira Roble Lappato
100x24,8 cm
P125F
GMD44201 30

Madeira Roble C-3 Clase3/R11/A+B+C
100x24,8 cm
P125E
GMD44101 30



Madeira Titanium
100x24,8 cm
P125D
GMD44023 34

Madeira Titanium Lappato
100x24,8 cm
P125F
GMD4411T 34

Madeira Titanium C-3 Clase3/R11/A+B+C
100x24,8 cm
P125E
GMD4407T 34



Madeira Ceniza
100x24,8 cm
P125D
GMD44012 32



Madeira Toscana
100x24,8 cm
P125D
GMD44013 24

Madeira Toscana Lappato
100x24,8 cm
P125F
GMD4412T 24



Madeira Blanco
100x24,8 cm
P125D
GMD44000 20

Madeira Blanco Lappato
100x24,8 cm
P125F
GMD44060 20



Madeira Gris
100x24,8 cm
P125D
GMD44002 16

Madeira Gris Lappato
100x24,8 cm
P125F
GMD44122 16



Madeira Grafito
100x24,8 cm
P125D
GMD4400J 20

Madeira Grafito C-3 Clase3/R11/A+B+C
100x24,8 cm
P125E
GMD4403J 20



Madeira Negro
100x24,8 cm
P125D
GMD4400K 30

Madeira Negro Lappato
100x24,8 cm
P125F
GMD4404K 30

PACKING LIST

formato/size	artículo/item	pzs-cj/pcs-box	m²/cj/box	kg/cj/box	cj/box/epl	m²/epl	kg/epl
100x24,8/40"x10"	Base / Lappato / C-3	3	0,74	17,67	40	29,60	729,80
8x50/3"x20"	Rodapié Natural / Lappato	10	0,40	9,60	120	48,00	1175,00
100x24,8/40"x10"	Peldaño Natural / Lappato / C-3	3	0,74	22,50	Please ask for information / Consulte información		
100x24,8/40"x10"	Peldaño Doble Natural / Lappato / C-3	2	0,50	12,60	Please ask for information / Consulte información		



WHITE BODY WALL TILES

REVESTIMIENTO PASTA BLANCA

FAIENCE PÂTE BLANCHE

WEISSSCHERBIGE WANDFLIESEN



Madeira Crema
30x90 cm

R90D
KMDPG001 14



Madeira Blanco
30x90 cm

R90C
KMDPG000 14



Perfil Acero Bronce
1,5x90 cm

S330
K432L00M



Perfil Acero Plata
1,5x90 cm

S330
K432L00L



Madeira Concept Roble
30x90 cm

R90F
KMDPG011 3



Madeira Concept Grafito
30x90 cm

R90F
KMDPG00J 3

PACKING LIST

formato/size	artículo/item	pzs-cj/pcs-box	m ² /cj/box	kg/cj/box	cj/box/epl	m ² /epl	kg/epl
30x90/12"x36"	Base / Concept	4	1,08	18,84	51	55,08	983,84
1,5x90/0,8"x36"	Perfil Acero	6	0,08	0,90	336	27,22	325,40

MILLENIUM

WALL TILES | MILLENIUM BLANCO BRILLO 30X90,
MILLENIUM FLOW BLANCO BRILLO 30X90
FLOOR TILES | PORTOBELLO FRESNO 100X24,8



30x90 12" x 36" **MILLENIUM**

WHITE BODY WALL TILES

REVESTIMIENTO PASTA BLANCA

FAIENCE PÂTE BLANCHE

WEISSSCHERBIGE WANDFLIESEN



Millenium Blanco Brillo
30x90 cm

R90D
KEHPG000



Millenium Blanco Mate
30x90 cm

R90D
KEHPG010



Millenium Rubik Blanco Brillo
30x90 cm

R90F
KEHPG060



Millenium Rubik Blanco Mate
30x90 cm

R90F
KEHPG070



Millenium Quilt Blanco Brillo
30x90 cm

R90F
KEHPG020



Millenium Quilt Blanco Mate
30x90 cm

R90F
KEHPG030



Millenium Flow Blanco Brillo
30x90 cm

R90F
KEHPG040



Millenium Flow Blanco Mate
30x90 cm

R90F
KEHPG050



Millenium Flow Negro Brillo
30x90 cm

R90F
KEHPG00K

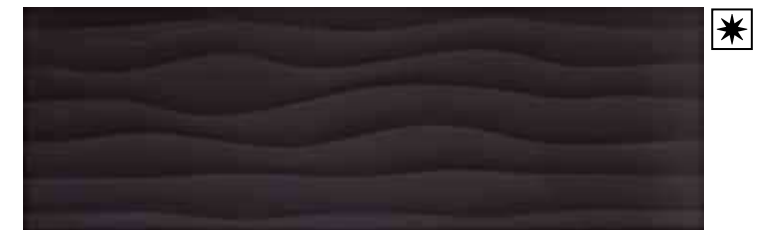

Millenium Flow Negro Mate
30x90 cm

R90F
KEHPG01K

WALL TILES | MILLENIUM QUILT BLANCO MATE 30X90, MILLENIUM BLANCO MATE 30X90, PERFIL ACERO PLATA 1,5X70
FLOOR TILES | FUTURE GRIS 60X60

PACKING LIST

formato/size	artículo/item	pzs-cj/pcs-box	m²cj/box	kg/cj/box	cj/box/epl	m²/epl	kg/epl
30x90/12"x36"	Base / Rubik / Quilt / Flow	4	1,08	18,84	51	55,08	983,84



30x90
12"x36" **MISTERY**

WHITE BODY WALL TILES

REVESTIMIENTO PASTA BLANCA

FAIÈNCE PÂTE BLANCHE

WEISSCHERBIGE WANDFLIESEN



Mistery White
30x90 cm
R90D K06PG010

14



Decor Boboli White
30x90 cm
S670 K06PG020



Perfil Metallic
2x90 cm
S290 KBLW3002



Listelo Boboli White
8,5x30 cm
S520 K060L000



Listelo Boboli Flow White
8,5x30 cm
S480 K060LK50



Zócalo Boboli White
12x30 cm
S520 K060M000

PACKING LIST

formato/size	artículo/item	pzs-cj/pcs-box	m²cj/box	kg/cj/box	cj/box/epl	m²/epl	kg/epl
30x90/12"x36"	Base	4	1,08	18,84	51	55,08	983,84
30x90/12"x36"	Decor	4	1,08	21,72	12	12,96	283,64
8,5x30/3,3"x12"	listelo Boboli	10	0,25	1,70	70	17,85	142,00
8,5x30/3,3"x12"	listelo Boboli Flow	12	0,30	2,04	65	19,89	155,60
12x30/4,7"x12"	Zócalo	14	0,50	13,44	65	32,76	896,60
2x90/0,8"x35,4"	Perfil Metallic	6	0,11	3,00	200	21,60	623,00

WALL TILES | MISTERY WHITE 30X90, DECOR BOBOLI WHITE 30X90,
LISTELO BOBOLI WHITE 8,5X30, ZÓCALO BOBOLI WHITE 12X30
FLOOR TILES | MISTERY WHITE 49X49



WALL TILES | MISTRAL BLANCO 25X50, MISTRAL NEGRO 25X50,
LISTELO TARIFA NEGRO 10X50
FLOOR TILES | MISTRAL NEGRO 50X50



25x50
10" x 20" **MISTRAL**

WHITE BODY WALL TILES

REVESTIMIENTO PASTA BLANCA

FAÏENCE PÂTE BLANCHE

WEISSSCHERBIGE WANDFLIESEN

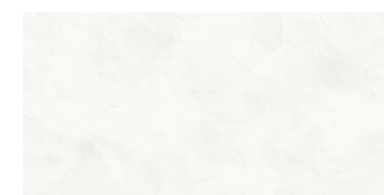

Mistral Blanco R25C
25x50 cm KMQ19000

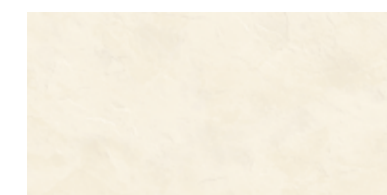

Mistral Beige R25C
25x50 cm KMQ19001

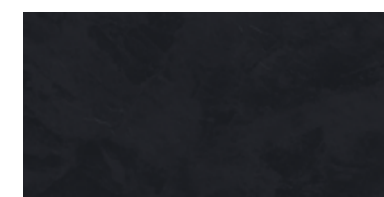

Mistral Negro R25D
25x50 cm KMQ1900K



Listelo Tarifa Negro S520
10x50 cm KMQK800K



Listelo Tarifa Moka S520
10x50 cm KMQK800D



50X50
20" X 20" **MISTRAL**

GLAZED PORCELAIN FLOOR TILES

PAVIMENTO PORCELÁNICO ESMALTADO

GRÈS CÉRAME ÉMAILLÉ

GLASIERTE FEINSTEINZEUG BODENFLIESEN

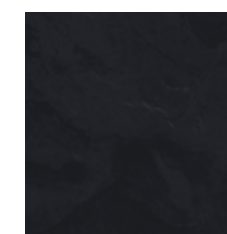

Mistral Negro P50C
50x50cm GMQ13002



Rounded edge skirting 8x50 | Rodapié romano 8x50 S150
Negro GMQVP00K

PACKING LIST

formato/size	artículo/item	pzs-cj/pcs-box	m ² cj/box	kg/cj/box	cj/box/epl	m ² /epI	kg/epI
25x50/10" x 20"	Base	11	1,38	21,78	36	49,68	807,08
10x50/4" x 20"	Listelo	10	0,50	9,00	48	24,00	455,00
50x50/20" x 20"	Base	4	1,00	20,52	36	36,00	761,72
8x50/3" x 20"	Rodapié	10	0,40	9,60	120	48,00	1175,00

MIXIT

WALL TILE | MIXIT GRIS 37X75, MIXIT GRAFITO 37X75
FLOOR TILE | MIXIT BLANCO 75X75



MIXIT

FLOOR TILE | MIXIT GRIS 75X75



WALL TILE | MIXIT GRIS 37X75
FLOOR TILE | MIXIT GRIS 75X75



Mixit Blanco
75x75 cm P75C GOW0R000 14
Mixit Blanco Antislip Clase3/R11/A+B+C P75E GOW0R010 14



Mixit Gris
75x75 cm P75C GOW0R002 14
Mixit Gris Antislip Clase3/R11/A+B+C P75E GOW0R012 14



Mixit Grafito
75x75 cm P75C GOW0R00J 14
Mixit Grafito Antislip Clase3/R11/A+B+C P75E GOW0R01J 14

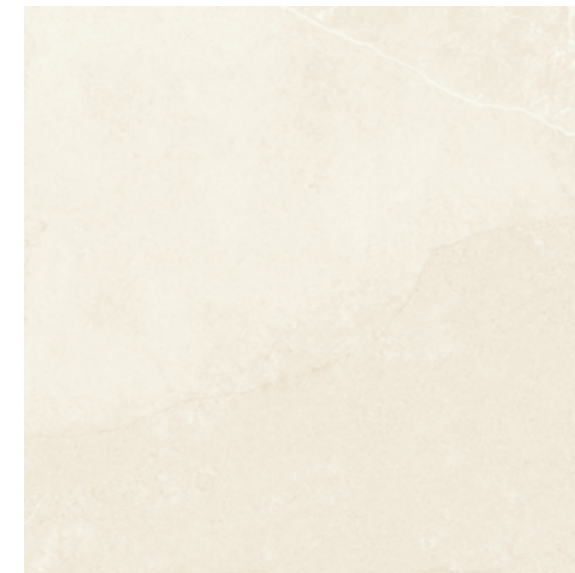

Mixit Beige
75x75 cm P75C GOW0R001 14
Mixit Beige Antislip Clase3/R11/A+B+C P75E GOW0R011 14

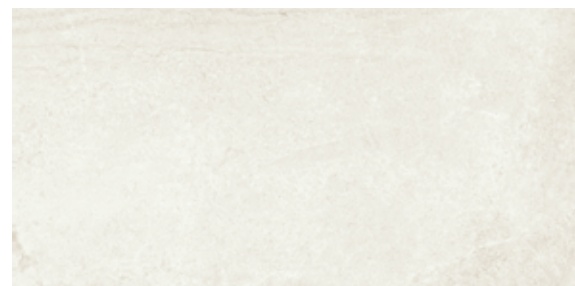

Mixit Blanco
37x75 cm P37C GOWAC000 28
Mixit Blanco Antislip Clase3/R11/A+B+C P37E GOWAC010 28



Mixit Gris
37x75 cm P37C GOWAC002 28
Mixit Gris Antislip Clase3/R11/A+B+C P37E GOWAC012 28



Mixit Grafito
37x75 cm P37C GOWAC00J 28
Mixit Grafito Antislip Clase3/R11/A+B+C P37E GOWAC01J 28

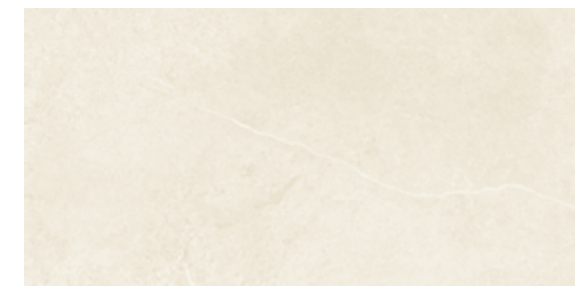

Mixit Beige
37x75 cm P37C GOWAC001 28
Mixit Beige Antislip Clase3/R11/A+B+C P37E GOWAC011 28



Muro Mixit Blanco
26x58 cm Y500 GOW0K000



Muro Mixit Gris
26x58 cm Y500 GOW0K002



Muro Mixit Grafito
26x58 cm Y500 GOW0K00J

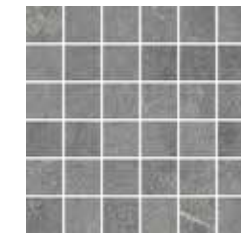

Mosaico Mixit Grafito
30x30 cm GOW0400J Y300



Muro Mixit Beige
26x58 cm Y500 GOW0K001



Mosaico Mixit Beige
30x30 cm GOW04001 Y300



Mosaico Mixit Blanco
30x30 cm GOW04000 Y300

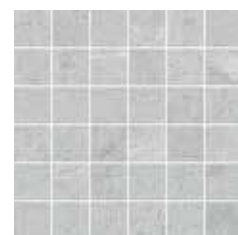

Mosaico Mixit Gris
30x30 cm GOW04002 Y300

	Rounded edge skirting 8x75 Rodapié romano 8x75 S290		Step 37x75 Peldaño simple 37x75 S560		Double Step 37x75 Peldaño doble 37x75 S690						
Blanco	GOW3E000	Beige	GOW3E001	Blanco	GOWAC020	Beige	GOWAC021	Blanco	GOWAC040	Beige	GOWAC041
Gris	GOW3E002	Grafito	GOW3E00J	Gris	GOWAC022	Grafito	GOWAC02J	Gris	GOWAC042	Grafito	GOWAC04J
			Step 37x75 Antislip Peldaño simple 37x75 Antislip S560						Double Step 37x75 Antislip Peldaño doble 37x75 Antislip S690		
Blanco	GOWAC030	Beige	GOWAC031	Blanco	GOWAC050	Beige	GOWAC051	Blanco	GOWAC052	Beige	GOWAC05J
Gris	GOWAC032	Grafito	GOWAC03J	Gris	GOWAC052	Grafito	GOWAC05J	Gris	GOWAC052	Grafito	GOWAC05J

PACKING LIST

formato/size	artículo/item	pzs-cj/pcs-box	m²cj/box	kg/cj/box	cj/box/epl	m²/epl	kg/epl
75x75/30" x30"	Base / Antislip	2	1,13	24,62	42	47,46	1057,04
37x75/15" x30"	Base / Antislip	4	1,13	24,24	48	54,24	1186,52
26x58/10" x24"	Muro	5	0,75	15,10	30	22,50	476,00
30x30/12" x12"	Mosaico	11	1,00	20,46	36	36,00	759,56
8x75/3" x30"	Rodapié	10	0,60	12,90	80	48,00	1055,00
37x75/15" x30"	Peldaño Base / Antislip	4	1,11	24,24	Please ask for information / Consulte información		
37x75/15" x30"	Peldaño Doble Base / Antislip	2	0,56	12,12	Please ask for information / Consulte información		

MIXIT

WALL TILE | MIXIT BEIGE 30X90, MIXIT CONCEPT BEIGE 30X90
FLOOR TILE | MIXIT BEIGE 75X75



WALL TILE | MIXIT BLANCO 30X90, MIXIT ART BLANCO 30X90



WALL TILE | MIXIT CONCEPT GRIS 30X90
FLOOR TILE | MIXIT GRIS 75X75



Mixit Blanco
30x90 cm

R90C
KOWPG000 14



Mixit Gris
30x90 cm

R90C
KOWPG002 14



Mixit Beige
30x90 cm

R90C
KOWPG001 14



Mixit Concept Blanco
30x90 cm

R90G
KOWPG010 9



Mixit Concept Gris
30x90 cm

R90G
KOWPG012 9



Mixit Concept Beige
30x90 cm

R90G
KOWPG011 9



Mixit Art Blanco
30x90 cm

R90H
KOWPG020 3



Mixit Art Gris
30x90 cm

R90H
KOWPG022 3



Mixit Art Beige
30x90 cm

R90H
KOWPG021 3



Perfil Acero Plata
1,5x90 cm

S330
K432L00L



Perfil Acero Bronce
1,5x90 cm

S330
K432L00M

PACKING LIST

formato/size	artículo/item	pzs-cj/pcs-box	m ² cj/box	kg/cj/box	cj/box/epl	m ² /epl	kg/epl
30x90/12"x36"	Base / Concept / Art	4	1,08	18,84	51	55,08	983,84
1,5x90/1,8"x36"	Perfil	6	0,08	0,90	336	27,22	325,40

MOOD

WALL TILE | MOOD BLANCO 30X90, MOOD OBLIQUE BLANCO 30X90
FLOOR TILE | SAVIA CREMA 150X24,8



WALL TILE | MOOD OCEANIC BLANCO 30X90



WHITE BODY WALL TILES

REVESTIMIENTO PASTA BLANCA

FAÏENCE PÂTE BLANCHE

WEISSSCHERBIGE WANDFLIESEN

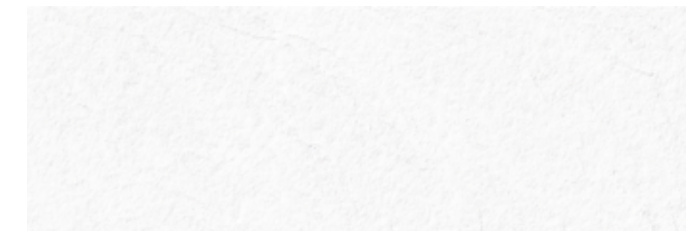

Mood Blanco
30x90 cm

R90C
KP7PG000 2



Mood Oblique Blanco
30x90 cm

R90G
KP7PG010



Mood Strata Blanco
30x90 cm

R90G
KP7PG020



Mood Oceanic Blanco
30x90 cm

R90G
KP7PG030



Perfil Acero Plata
1,5x90 cm

S330
K432L00L

PACKING LIST

formato/size	artículo/item	pzs-cj/pcs-box	m²cj/box	kg/cj/box	cj/box/epl	m²/epl	kg/epl
30x90/12"x36"	Base	4	1,08	18,84	51	55,08	983,84
1,5x90/1,8"x36"	Perfil	6	0,08	0,90	336	27,22	325,40

NATURE

FLOOR TILES | NATURE BLACK 75X75

NATURE

100x50 | 75x75 | 37x75/ | 60x60 | 50x50
 40" x 20" | 30" x 30" | 15" x 30" | 24" x 24" | 20" x 20"

COLOURED BODY PORCELAIN FLOOR TILES | PAVIMENTO PORCELÁNICO COLOREADO | GRÉS CÉRAME COLORE | DURCHGEFÄRBTE FEINSTEINZEUGBODENFLIESEN



Natural: Clase I | RIØ
 Antislip: Clase 3 | R11 | A+B+C
 2Ø MM: Clase 3 | R11 | A+B+C



Nature Bone 100x50 cm P100C G4321011 13
 Nature Bone Antislip Clase3/R11/A+B+C P100F G4321061 13



Nature Bone 75x75 cm P37C G43AC001 28
 Nature Bone Antislip Clase3/R11/A+B+C P37E GNAAC001 28



Muro Nature Bone 26x58 cm Y500 G430K001

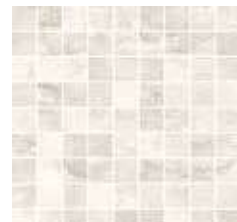

Mosaico Nature Bone 30x30 cm G4304001 Y500



Nature Bone 50x50 cm P50E G4313011 21



Nature Bone 75x75 cm P75C G430R001 14
 Nature Bone Antislip Clase3/R11/A+B+C P75E G430R041 14
 Nature Bone 2ØMM Clase3/R11/A+B+C P75G G430R071 14



Nature Bone 60x60 cm P64D G434200K 16
 Nature Bone 2ØMM Clase3/R11/A+B+C P64G G4342021 12



Nature Grey 100x50 cm P100C G4321002 12
 Nature Grey Antislip Clase3/R11/A+B+C P100F G4321032 13



Nature Grey 75x75 cm P37C G43AC002 28
 Nature Grey Antislip Clase3/R11/A+B+C P37E G43AC032 28



Muro Nature Grey 26x58 cm Y500 G430K002



Mosaico Nature Grey 30x30 cm G4304002 Y500



Nature Grey 75x75 cm P75C G430R002 14
 Nature Grey Antislip Clase3/R11/A+B+C P75E G430R022 14
 Nature Grey 2ØMM Clase3/R11/A+B+C P75G G430R000 14



Nature Grey 60x60 cm P64D G4342002 16
 Nature Grey 2ØMM Clase3/R11/A+B+C P64G G4342000 12



Nature Grey 50x50 cm P50E G4313002 21

NO RECTIFICADO

NO RECTIFICADO



Nature Black 75x75 cm P75D G430R00K 14



Nature Black 100x50 cm P100D G432100K 13



Nature Black 60x60 cm P64E G434201K 15



Nature Black 37x75 cm P37D G43AC00K 28

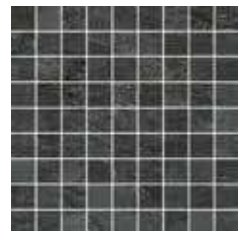

Mosaico Nature Black 30x30 cm G430400K Y500



Muro Nature Black 26x58 cm Y500 G430K00K



Nature Beige 75x75 cm P75C G430R011 14



Nature Beige 100x50 cm P100C G4321001 13



Nature Beige 60x60 cm P64D G4342001 16



Nature Beige 37x75 cm P37C G43AC021 28



Mosaico Nature Beige 30x30 cm G4304011 Y500



Muro Nature Beige 26x58 cm Y500 G430K011

PACKING LIST

formato/size	artículo/item	pzs-cj/pcs-box	m ² /cj/box	kg/cj/box	cj/box/epl	m ² /epl	kg/epl
100x50/40"x20"	Base / Antislip	2	1,00	23,60	28	28,00	683,80
75x75/30"x30"	Base / Antislip	2	1,13	24,62	42	47,46	1057,04
75x75/30"x30"	20 MM	1	0,56	24,91	42	23,52	1069,22
60x60/24"x24"	Base	3	1,08	22,53	40	43,20	924,20
60x60/24"x24"	20 MM	2	0,72	31,72	32	23,04	1038,04
37x75/15"x30"	Base / Antislip	4	1,13	24,24	48	54,24	1186,52
50x50/20"x20"	Base	4	1,00	20,52	36	36,00	761,72
30x30/12"x12"	Mosaico	11	1,00	20,46	36	36,00	759,56
26x58/10"x24"	Muro	5	0,75	7,00	30	22,50	233,00
8x60/3"x24"	Rodapié	10	0,48	11,30	80	38,40	943,00
30x60/12"x24"	Peldaño	6	1,08	20,58	Please ask for information / Consulte información		
30x60/12"x24"	Peldaño Doble	2	0,36	13,28	Please ask for information / Consulte información		
8x75/3"x30"	Rodapié	10	0,60	12,90	80	48,00	1055,00
37x75/15"x30"	Peldaño/Peldaño Antislip	4	1,11	24,24	Please ask for information / Consulte información		
37x75/15"x30"	Peldaño Doble / Peldaño Doble Antislip	2	0,56	12,12	Please ask for information / Consulte información		
75x75/30"x30"	Peldaño 20MM	1	0,56	24,91	42	23,64	1069,22
8x50/3"x20"	Rodapié	10	0,40	9,60	120	48,00	1175,00
100x50/40"x20"	Peldaño/Peldaño Antislip	2	1,00	25,20	Please ask for information / Consulte información		
100x50/40"x20"	Peldaño Doble / Peldaño Doble Antislip	2	1,00	28,34	Please ask for information / Consulte información		

Rounded edge skirting 8x50 Rodapié romano 8x50	S150
Bone G43VP021 Beige G43VP031	
Black G43VP00K Grey G43VP002	
Rounded edge skirting 8x60 Rodapié romano 8x60	S280
Bone G43RQ001 Beige G43VP011	
Black G43RQ00K Grey G43RQ002	
Rounded edge skirting 8x75 Rodapié romano 8x75	S290
Black G433E00K Bone G433E001	
Grey G433E002 Beige G443E011	

Step 100x50 Peldaño simple 100x50	S600
Bone G4321021 Beige G4321031	
Black G432101K Grey G4321012	
Step 100x50 Antislip Peldaño simple 100x50 Antislip	S600
Bone G4321081 Grey G4321000	
Step 30x60 Peldaño simple 30x60	S500
Black G430500K Beige G4305001	
Grey G4305002 Beige G4305031	
Step 37x75 Peldaño simple 37x75	S560
Black G43AC01K Bone G43AC011	
Grey G43AC012 Beige G43AC031	
Step 37x75 Antislip Peldaño simple 37x75 Antislip	S560
Bone G43AC081 Grey G43AC042	
Step 75x75 20MM Peldaño simple 75x75 20MM	S670
Bone G430R081 Grey G430R010	

Double Step 100x50 Peldaño doble 100x50	S720
Bone G4321041 Beige G4321051	
Black G432102K Grey G4321022	
Double Step 100x50 Antislip Peldaño doble 100x50 Antislip	S720
Bone G4321131 Grey G4321042	
Double Step 30x60 Peldaño doble 30x60	S650
Bone G4305011 Beige G4305041	
Black G430502K Grey G4305012	
Double Step 37x75 Peldaño doble 37x75	S690
Black G430503K Bone G4305021	
Grey G4305022 Beige G43AC041	
Double Step 37x75 Antislip Peldaño doble 37x75 Antislip	S690
Bone G43AC141 Grey G43AC052	



30x90
12" x 36" **NATURE**

WHITE BODY WALL TILES

REVESTIMIENTO PASTA BLANCA

FAÏENCE PÂTE BLANCHE

WEISSSCHERBIGE WANDFLIESEN



Nature Bone
30x90 cm

R90D
K43PG001 14



Nature Grey
30x90 cm

R90D
K43PG002 14



Nature Concept Bone
30x90 cm

R90F
K43PG011 3



Nature Concept Grey
30x90 cm

R90F
K43PG012 3



Perfil Acero Bronze
1,5x90 cm

S330
K432L00M



Perfil Acero Plata
1,5x90 cm

S330
K432L00L

PACKING LIST

formato/size	artículo/item	pzs-cj/pcs-box	m²cj/box	kg/cj/box	cj/box/epl	m²/epl	kg/epl
30x90/12" x 36"	Base / Concept	4	1,08	18,84	51	55,08	983,84
1,5x90/0,8" x 36"	Perfil Acero	6	0,08	0,90	336	27,22	325,40

WALL TILES | NATURE GREY 30X90, NATURE CONCEPT GREY 30X90,
PERFIL ACERO PLATA 1,5X90
FLOOR TILES | NATURE GREY 60X60

PALATINO



WALL TILE | PALATINO WHITE HONED 18X73
FLOOR TILE | PALATINO WHITE HONED 73X73

PALATINO

73x73 | 36x73 | 18x73
28" x 28" | 14" x 28" | 7" x 28"



GLAZED PORCELAIN FLOOR TILES | PAVIMENTO PORCELÁNICO ESMALTADO | GRÉS CÉRAME ÉMAILLÉ | GLASIERTE FEINSTEINZEUG BODENFLIESEN



Palatino White Honed
73x73 cm P75H GK85N000 14



Palatino Grey Honed
73x73 cm P75H GK85N010 14



Palatino Beige Honed
73x73 cm P75H GK85N001 14



Palatino White Honed
36x73 cm P37H GK85P000 28



Palatino Grey Honed
36x73 cm P37H GK85P010 28



Palatino Beige Honed
36x73 cm P37H GK85P001 28



Palatino White Honed
18x73 cm P18H GK85Q000 56



Palatino Grey Honed
18x73 cm P18H GK85Q010 56



Palatino Beige Honed
18x73 cm P18H GK85Q001 56



Muro Palatino White Honed
26x58 cm Y500 GK80K000



Muro Palatino Grey Honed
26x58 cm Y500 GK80K010



Muro Palatino Beige Honed
26x58 cm Y500 GK80K001



Mosaico Palatino Beige Honed
30x30 cm Y500 GK804001

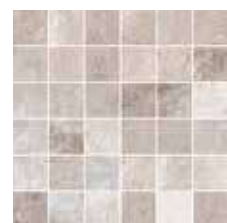

Mosaico Palatino White Honed
30x30 cm Y500 GK804000

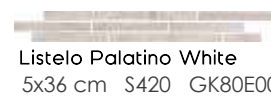

Listelo Palatino White
5x36 cm S420 GK80E000



Mosaico Palatino Grey Honed
30x30 cm Y500 GK804010

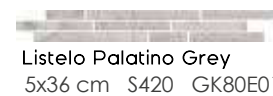

Listelo Palatino Grey
5x36 cm S420 GK80E010

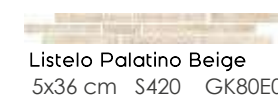

Listelo Palatino Beige
5x36 cm S420 GK80E001

PACKING LIST

formato/size	artículo/item	pzs-cj/pcs-box	m²cj/box	kg/cj/box	cj/box/epl	m²/epl	kg/epl
73x73/28" x 28"	Base	2	1,07	23,96	42	44,94	1029,32
36x73/14" x 28"	Base	4	1,07	23,60	48	51,36	1155,80
18x73/7" x 28"	Base	9	1,19	25,20	48	57,12	1232,60
5x36/2" x 14"	Listelo	10	0,18	2,60	120	21,60	335,00
26x58/10" x 24"	Muro	5	0,75	15,10	30	22,50	476,00
30x30/12" x 12"	Mosaico	11	1,00	20,46	36	36,00	759,56

PETIT GRANIT



WALL TILES | PETIT GRANIT GRAFITO 30X60
FLOOR TILES | PETIT GRANIT GRAFITO 60X60

PETIT GRANIT

60X60 | 30X60

24" x 24" | 12" x 24"

COLOURED BODY PORCELAIN FLOOR TILES | PAVIMENTO PORCELÁNICO COLOREADO | GRÉS CÉRAME COLORE | DURCHGEFÄRBTE FEINSTEINZEUGBODENFLIESEN



Natural: Clase I | R9

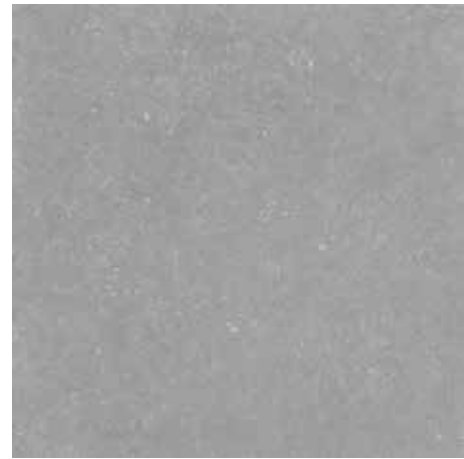

Petit Granit Gris
60x60 cm P64E GB1AN022 16



Petit Granit Grafito
60x60 cm P64E GB1AN02J 17



Petit Granit Negro
60x60 cm P64E GB1AN02K 15



Petit Granit Crema
60x60 cm P64D GB1AN02I 17



Petit Granit Visón
60x60 cm P64E GB14210B 17



Petit Granit Moka
60x60 cm P64E GB142103 17



Petit Granit Gris
30x60 cm P34E GB105282 32



Petit Granit Grafito
30x60 cm P34E GB10517J 34



Petit Granit Negro
30x60 cm P34E GB10518K 30



Petit Granit Crema
30x60 cm P34D GB10513I 17



Petit Granit Visón
30x60 cm P34E GB10511B 34



Petit Granit Moka
30x60 cm P34E GB105163 34

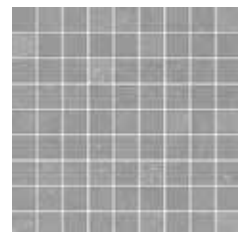

Mosaico Petit Granit Gris
30x30 cm GB104102 Y600

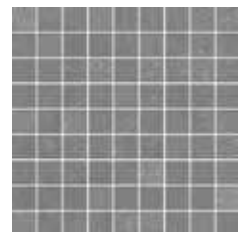

Mosaico Petit Granit Grafito
30x30 cm GB10410J Y600

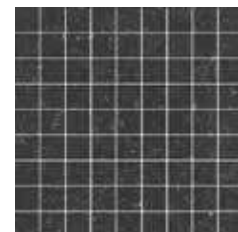

Mosaico Petit Granit Negro
30x30 cm GB10410K Y600

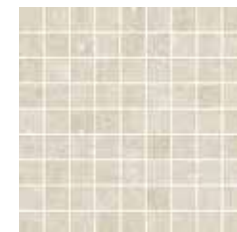

Mosaico Petit Granit Crema
30x30 cm GB10410I Y600

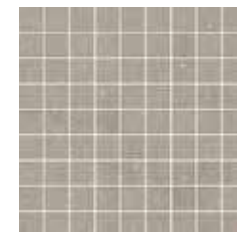

Mosaico Petit Granit Visón
30x30 cm GB10410B Y600

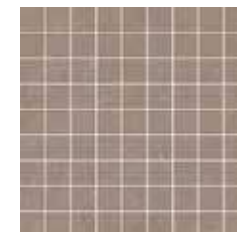

Mosaico Petit Granit Moka
30x30 cm GB104103 Y600



PACKING LIST

formato/size	artículo/item	pzs-cj/pcs-box	m ² cj/box	kg/cj/box	cj/box/epl	m ² /ep1	kg/ep1
60x60/24" x 24"	Base	3	1,08	22,53	40	43,20	924,20
30x60/12" x 24"	Base	6	1,08	22,32	40	43,20	915,80
30x30/12" x 12"	Mosaico	11	1,00	20,46	36	36,00	759,56
8x60/3" x 24"	Rodapié	10	0,48	11,30	80	38,40	943,00
30x60/12" x 24"	Peldaño	6	1,08	20,58	Please ask for information / Consulte información		
30x60/12" x 24"	Peldaño Doble	2	0,36	13,28	Please ask for information / Consulte información		

PORTOBELLO





100x24,8 | 18,5x75 **PORTOBELLO**
40"X10" | 7"X30"

COLOURED BODY PORCELAIN FLOOR TILES | PAVIMENTO PORCELÁNICO COLOREADO
GRES CERÁME COLORE | DURCHGEFÄRBTE FEINSTEINZEUGBODENFLIESEN

Natural: Clase I | R9
Antislip: Clase 3 | R11 | A+B+C



Portobello Blanco
100x24,8 cm

P125D
GFK44000



Portobello Blanco
18,5x75 cm

P18D
GFKZZ000



Portobello Fresno
100x24,8 cm

P125D
GFK44001



Portobello Fresno
18,5x75 cm

P18D
GFKZZ011



Portobello Roble
100x24,8 cm

P125D
GFK44011



Portobello Roble
18,5x75 cm

P18D
GFKZZ001

Portobello Roble Antislip Clase3/R11/A+B+C
100x24,8 cm

P125E
GFK44021

Portobello Roble Antislip Clase3/R11/A+B+C
18,5x75 cm

P18E
GFKZZ021



Portobello Nogal
100x24,8 cm

P125D
GFK44003



Portobello Nogal
18,5x75 cm

P18D
GFKZZ00N

Portobello Nogal Antislip Clase3/R11/A+B+C
100x24,8 cm

P125E
GFK44013

	Rounded edge skirting 8x50 Rodapié romo 8x50 S150
Blanco	GFKVP000
Fresno	GFKVP011
Roble	GFKVP001
Nogal	GFKVP00D

	Step 100x24,8 Peldaño simple 100x24,8	S600	
Blanco	GFK44050	Roble	GFK44023
Fresno	GFK44010	Nogal	GFK4400D

	Double Step 100x24,8 Peldaño doble 100x24,8	S720	
Blanco	GFK44020	Roble	GFK44033
Fresno	GFK44061	Nogal	GFK4401D

	Step 100x24,8 Antislip Peldaño simple 100x24,8 Antislip	S600	
Roble	GFK44053	Nogal	GFK4403D

	Double Step 100x24,8 Antislip Peldaño doble 100x24,8 Antislip	S720	
Roble	GFK44043	Nogal	GFK4402D

PACKING LIST

formato/size	artículo/item	pzs-cj/pcs-box	m²cj/box	kg/cj/box	cj/box/epl	m²/epl	kg/epl
100x24,8/40"x10"	Base / Antislip	3	0,74	17,67	40	29,60	729,80
8x50/3"x20"	Rodapié	10	0,40	9,60	120	48	1175,00
18,5x75 / 7"x30"	Base / Antislip	8	1,11	24,64	48	53,28	1205,72
100x24,8/40"x10"	Peldaño / Antislip	3	0,74	22,50	Please ask for information / Consulte información		
100x24,8/40"x10"	Peldaño Doble / Antislip	2	0,50	12,60	Please ask for information / Consulte información		

PRIORAT

WALL TILES | PRIORAT CEMENTO 25X70, PRIORAT BLANCO 25X70,
PRIORAT CONCEPT CEMENTO 25X70
FLOOR TILES | PRIORAT CEMENTO 60X60, PRIORAT MODUL CEMENTO 60X60



Priorat Blanco 60x60 cm P64D GHW42000 18
Priorat Blanco Antislip 60x60 cm P64E GHW42080 18
Clase3/R10/A+B+C



Priorat Cemento 60x60 cm P64D GHW4200C 18
Priorat Cemento Antislip 60x60 cm P64E GHW4203C 18
Clase3/R10/A+B+C



Priorat Grafito 60x60 cm P64D GHW4200J 18
Priorat Grafito Antislip 60x60 cm P64E GHW4204J 18
Clase3/R10/A+B+C



Priorat Blanco 30x60 cm P34D GHW05000 36
Priorat Blanco Antislip 30x60 cm P34E GHW05110 36
Clase3/R10/A+B+C



Priorat Cemento 30x60 cm P34D GHW0500C 36
Priorat Cemento Antislip 30x60 cm P34E GHW0503C 36
Clase3/R10/A+B+C



Priorat Grafito 30x60 cm P34D GHW0500J 36
Priorat Grafito Antislip 30x60 cm P34E GHW0503J 36
Clase3/R10/A+B+C



Priorat Modul Blanco 60x60 cm P64E GHW42060 4



Priorat Modul Cemento 60x60 cm P64E GHW4202C 4



Priorat Modul Grafito 60x60 cm P64E GHW4203J 4

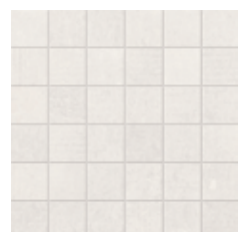

Mosaico Priorat Blanco 30x30 cm GHW04000 Y300



Muro Priorat Blanco 22,8x39 cm KHWI3000 Y300



Mosaico Priorat Cemento 30x30 cm GHW0400C Y300



Muro Priorat Cemento 22,8x39 cm KHWI300C Y300



Mosaico Priorat Grafito 30x30 cm GHW0400J Y300



Muro Priorat Grafito 22,8x39 cm KHWI300J Y300



WALL TILES | PRIORAT CONCEPT NATURAL 25X70
 FLOOR TILES | PRIORAT NATURAL 60X60, PRIORAT NATURAL MODUL 60X60



25x70
 10" x 28" **PRIORAT**

WHITE BODY WALL TILES

REVESTIMIENTO PASTA BLANCA

FAÏENCE PÂTE BLANCHE

WEISSSCHERBIGE WANDFLIESEN



Priorat Blanco
 25x70 cm

R27D
 KHWZA000 **15**



Priorat Beige
 25x70 cm

R27D
 KHWZA001 **14**



Priorat Concept Blanco
 25x70 cm

R27G
 KHWZA020 **6**



Priorat Concept Beige
 25x70 cm

R27G
 KHWZA011 **6**



Listelo Priorat Cemento
 5,8x70 cm

S490
 KHWMV00C



Listelo Priorat Natural
 5,8x70 cm

S490
 KHWMV000



Priorat Cemento
 25x70 cm

R27D
 KHWZA00C **16**



Priorat Natural
 25x70 cm

R27D
 KHWZA010 **17**



Priorat Concept Cemento
 25x70 cm

R27G
 KHWZA01C **6**



Priorat Concept Natural
 25x70 cm

R27G
 KHWZA030 **6**

PACKING LIST

formato/size	artículo/item	pzs-cj/pcs-box	m²/cj/box	kg/cj/box	cj/box/epl	m²/epl	kg/epl
25x70/10" x 28"	Base / Concept	7	1,23	21,35	42	51,66	919,70
5,8x70/2,3" x 28"	Listelo	6	0,24	4,80	144	35,08	714,20

REMAKE





REMAKE

FLOOR TILE | REMAKE30 VISÓN 60X60



WALL TILE | REMAKE MULTICOLOR20 60X60
FLOOR TILE | REMAKE MULTICOLOR20 60X60, REMAKE VISÓN 60X60



Remake Blanco
60x60 cm P64C
KOU42000 18



Remake Gris
60x60 cm P64C
GOU42002 18



Remake Crema
60x60 cm P64C
KOU42001 18



Remake Visón
60x60 cm P64C
GOU4200C 18



Remake30 Blanco
60x60 cm P64E
GOU42000 10



Remake20 Multicolor Gris
60x60 cm P64E
GOU42042 8



Remake30 Gris
60x60 cm P64E
GOU42022 10

Remake30 Gris Antislip
Clase3/R10/A+B
60x60 cm P64E
GOU42032 10



Remake30 Crema
60x60 cm P64E
GOU42001 10



Remake20 Multicolor
60x60 cm P64E
GOU4200N 8



Remake30 Visón
60x60 cm P64E
GOU4202C 10

Remake30 Visón Antislip
Clase3/R10/A+B
60x60 cm P64E
GOU4203C 10



Remake Blanco
30x60 cm P34C
GOU05000 34

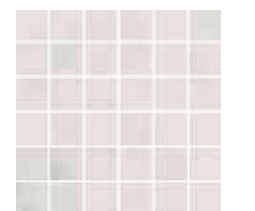

Mosaico Remake Blanco
30x30 cm GOU04000
Y300

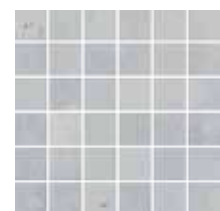

Mosaico Remake Gris
30x30 cm GOU04002
Y300



Remake Gris
30x60 cm P34C
GOU05002 34



Remake Crema
30x60 cm P34C
GOU05010 34

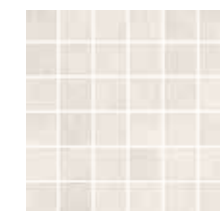

Mosaico Remake Crema
30x30 cm GOU04001
Y300



Mosaico Remake Visón
30x30 cm GOU0400C
Y300



Remake Visón
30x60 cm P34C
GOU0500C 34

PACKING LIST

formato/size	artículo/item	pzs-cj/pcs-box	m²cj/box	kg/cj/box	cj/box/epl	m²/epl	kg/epl
60x60/24"x24"	Base / Antislip	3	1,08	22,53	40	43,20	924,20
30x60/12"x24"	Base	6	1,08	22,32	40	43,20	915,80
30x30/12"x12"	Mosaico	11	1,00	20,46	36	36,00	759,56
8x60/3"x24"	Rodapié	10	0,48	11,30	80	38,40	943,00
30x60/12"x24"	Peldaño Base / Antislip	6	1,08	20,58	Please ask for information / Consulte información		
30x60/12"x24"	Peldaño Doble Base / Antislip	2	0,36	13,28	Please ask for information / Consulte información		

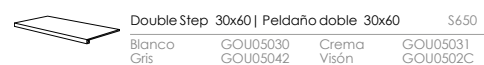

REMAKE



WALL TILE | REMAKE GRIS 25X70, REMAKE CONCEPT BLANCO 25X70
FLOOR TILE | REMAKE GRIS 60X60





Remake Blanco
25x70 cm

R27C
KOUZA000 18



Remake Crema
25x70 cm

R27C
KOUZA001 18



Remake Concept Blanco
25x70 cm

R27G
KOUZA010 6



Remake Concept Crema
25x70 cm

R27G
KOUZA011 6



Remake Gris
25x70 cm

R27C
KOUZA002 18



Remake Visión
25x70 cm

R27C
KOUZA00C 18

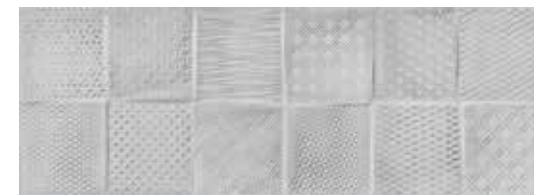

Remake Concept Gris
25x70 cm

R27G
KOUZA012 6



Remake Concept Visión
25x70 cm

R27G
KOUZA01C 6

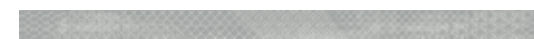

Listelo Remake Gris
3,8x70 cm

S350
KOU35002



Listelo Remake Visión
3,8x70 cm

S350
KOU3500C



Perfil Acero Plata
1,5x70 cm

S300
KZD2800L



Perfil Acero Bronce
1,5x70 cm

S300
KZD2800M

PACKING LIST

formato/size	artículo/item	pcs-cj/pcs-box	m²cj/box	kg/cj/box	cj/box/epl	m²/epl	kg/epl
25x70/10" x 28"	Base / Concept	7	1,23	21,35	42	51,66	919,70
3,8x70/15" x 27"	Listelo	6	0,16	3,06	144	22,98	463,64
1,5x70/1,8" x 28"	Perfil	6	0,06	0,72	400	25,20	311,00

SAVIA



FLOOR TILE | SAVIA CENTURY 18,5X75



SAVIA

FLOOR TILE | SAVIA ROBLE 150X24,8



FLOOR TILE | SAVIA ROBLE 150X24,8



Natural: Clase I | R9
Antislip: Clase 3 | R11 | A+B+C



Savia Blanco
150x24,8 cm
Savia Blanco Antislip Clase3/R11/A+B+C
150x24,8 cm

P524D 24
GKW5C000
P524E 24
GKW5C010



Savia Gris
150x24,8 cm

P524D 24
GKW5C002



Savia Crema
150x24,8 cm

P524D 24
GKW5C011



Savia Roble
150x24,8 cm
Savia Roble Antislip Clase3/R11/A+B+C
150x24,8 cm

P524D 24
GKW5C001
P524E 24
GKW5C031



Savia Century
150x24,8 cm

P524D 24
GKW5C00C



Savia Blanco
18,5x75 cm
Savia Blanco Antislip Clase3/R11/A+B+C
18,5x75 cm

P18D 60
GKWZZ000
P18E 60
GKWZZ010



Savia Gris
18,5x75 cm

P18D 60
GKWZZ002



Savia Crema
18,5x75 cm

P18D 60
GKWZZ001



Savia Roble
18,5x75 cm
Savia Roble Antislip Clase3/R11/A+B+C
18,5x75 cm

P18D 60
GKWZZ011
P18E 60
GKWZZ021



Savia Century
18,5x75 cm

P18D 60
GKWZZ00C

Rounded edge skirting 8x75 | Rodapié romo 8x75 S290
Blanco Gris Crema GKW3E000 GKW3E002 GKW3E011 Roble Century GKW3E001 GKW3E00C

Step (SR) 150x37 | Peldaño simple (SR) 150x37 S690
Blanco Gris Crema GKW5T020 GKW5T012 GKW5T041 Roble Century GKW5T021 GKW5T01C
Step (SR) 150x37 Antislip | Peldaño (SR) simple 150x37 Antislip S690
Blanco GKW5T030 Roble GKW5T031

Double Step 150x37 | Peldaño doble 150x37 S750
Blanco Gris Crema GKW5T040 GKW5T022 GKW5T071 Roble Century GKW5T051 GKW5T02C
Double Step 150x37 Antislip | Peldaño doble 150x37 Antislip S750
Blanco GKW5T050 Roble GKW5T061

Double step right corner 150x37 | Peldaño doble esq der 150x37 S790
Blanco Gris Crema GJM5T010 GJM5T032 GJM5T091 Roble Century GJM5T001 GJM5T03C
Double step right corner antislip 150x37 | Peldaño doble esq der antislip 150x37 S790
Blanco GJM5T020 Roble GJM5T081

Double step left corner 150x37 | Peldaño doble esq izq 150x37 S790
Blanco Gris Crema GKW5T040 GKW5T042 GKW5T131 Roble Century GKW5T111 GKW5T04C
Double step left corner antislip 150x37 | Peldaño doble esq izq antislip 150x37 S790
Blanco GKW5T070 Roble GKW5T121

Rounded edge skirting right 8x37 | Zanquín derecho 8x37 S520
Blanco Gris Crema GKW3E010 GKW3E012 GKW3E041 Roble Century GKW3E021 GKW3E01C

Rounded edge skirting left 8x37 | Zanquín izquierdo 8x37 S520
Blanco Gris Crema GKW3E020 GKW3E022 GKW3E051 Roble Century GKW3E031 GKW3E02C

PACKING LIST

formato/size	artículo/item	pzs-cj/pcs-box	m ² cj/box	kg/cj/box	cj/box/epI	m ² /epI	kg/epI
150x24,8/60"x10"	Base / Antislip	3	1,12	26,79	40	44,80	1094,60
18,5x75/7"x30"	Base / Antislip	8	1,11	24,64	48	53,28	1205,72
8x75/3"x30"	Rodapié	10	0,60	12,90	80	48,00	1055,00
150X37/60"x15"	Peldaño / Antislip	2	1,11	26,80	Please ask for information / Consulte información		
150X37/60"x15"	Peldaño Doble / Antislip	2	1,11	26,80	Please ask for information / Consulte información		
150X37/60"x15"	Peldaño Base / Antislip / Izquierdo / Derecho	ND	ND	ND	ND	ND	ND
150X37/60"x15"	Peldaño Doble Base / Antislip Izquierdo / Derecho	ND	ND	ND	ND	ND	ND
8x37/3"x15	Zanquín Izquierdo / Derecho	ND	ND	ND	ND	ND	ND



WALL TILES | SOHO BLANCO 25X70, LÍNEAS SOHO GRIS 25X70
LISTELO SOHO GRIS 3,9X70

SOHO 50X50 20" X 20"

GLAZED PORCELAIN FLOOR TILES | PAVIMENTO PORCELÁNICO ESMALTADO | GRÉS CÉRAME ÉMAILLÉ | GLASIERTE FEINSTEINZEUG BODENFLIESEN

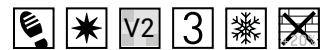

Soho Gris P50C
50x50cm GBF13002



Soho Arena P50C
50x50cm GBF13003



25x70 SOHO 10" x 28"

WHITE BODY WALL TILES | REVESTIMIENTO PASTA BLANCA | FAÏENCE PÂTE BLANCHE | WEISSSCHERBIGE WANDFLIESEN



Soho Blanco R27C
25x70 cm KBFZA000



Listelo Soho Gris S350
3,8x70 cm KBF35002



Soho Gris R27C
25x70 cm KBFZA002



** Decor Battery Blanco (Set 3 Pzs) S600
25x70 cm KBFZA030



Líneas Soho Gris R27F
25x70 cm KBFZA022



Soho Crema R27C
25x70 cm KBFZA001



Listelo Soho Arena S350
3,8x70 cm KBF35003



Soho Arena R27C
25x70 cm KBFZA003



** Decor Battery Crema (Set 3 Pzs) S600
25x70 cm KBFZA011



Líneas Soho Arena R27F
25x70 cm KBFZA013

Rounded edge skirting 8x50 | Rodapié ramo 8x50 S150
Arena GBFVP003 Gris GBFVP002

PACKING LIST

formato/size	artículo/item	pzs-cj/pcs-box	m²/cj/box	kg/cj/box	cj/box/epl	m²/epl	kg/epl
25x70/10" x 28"	Base / Líneas	7	1,23	21,35	42	51,66	919,70
25x70/10" x 28"	Decor	3	0,52	10,08	42	22,05	446,36
3,8x70/1,5" x 28"	Listelo	6	0,16	3,06	144	22,98	463,64
50x50/20" x 20"	Base	4	1,00	20,52	36	36,00	761,72
8x50/3" x 20"	Rodapié	10	0,40	9,60	120	48,00	1175,00



FLOOR TILES | STONETECH BLACK 60X60

PACKING LIST

formato/size	artículo/item	pzs-cj/pcs-box	m ² cj/box	kg/cj/box	cj/box/epl	m ² /epI	kg/epI
75x75/30"x30"	Base / Soft	2	1,13	24,62	42	47,46	1057,04
75x75/30"x30"	20 MM	1	0,56	24,91	42	23,52	1069,22
60x60/24"x24"	Base	3	1,08	22,53	40	43,20	924,20
60x60/24"x24"	20 MM	2	0,72	31,72	32	23,04	1038,04
30x60/12"x24"	Base	6	1,08	22,32	40	43,20	915,80
8x60/3"x24"	Rodapié	10	0,48	11,3	80	38,40	943,00
30x60/12"x24"	Peldaño	6	1,08	20,58	Please ask for information / Consulte información		
30x60/12"x24"	Peldaño Doble	2	0,36	13,28	Please ask for information / Consulte información		
60x60/24"x24"	Peldaño 20 MM	2	0,71	31,72	32	23,04	1038,04
75x75/30"x30"	Peldaño 20 MM	1	0,56	24,91	42	23,52	1069,22



75x75 | 60x60 | 30x60
30"x30" | 24"x24" | 12"x24"

STONETECH

COLOURED BODY PORCELAIN FLOOR TILES | PAVIMENTO PORCELÁNICO COLOREADO
GRES CERAME COLOPÉ | DURCHGEFÄRBTE FEINSTEINZEUGBODENFLIESEN

Natural: Clase I | R9
2Ø MM: Clase 3 | R11 | A+B+C

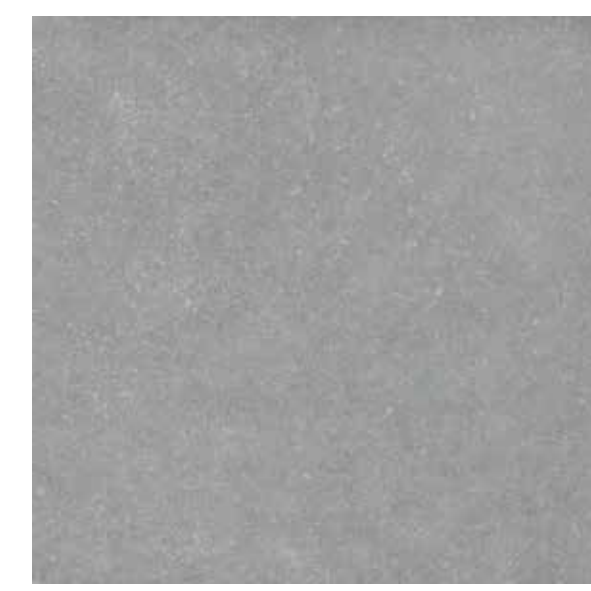

Stonetech Gráfico 2ØMM Clase3/R11/A+B+C P75G GI40R00J 12
75x75 cm

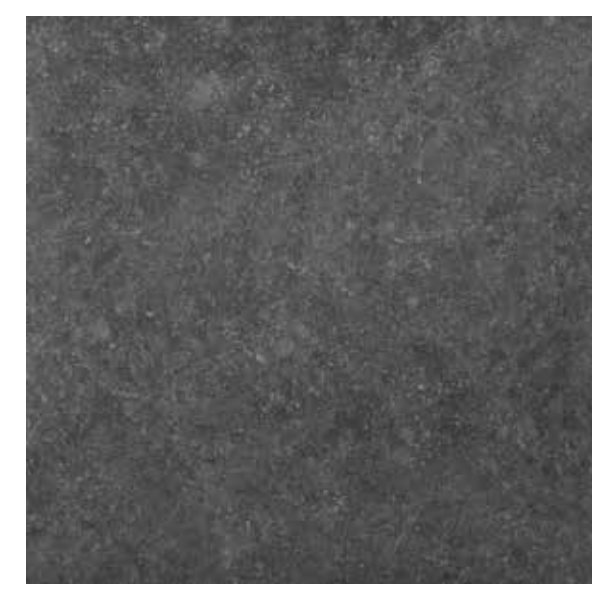

Stonetech Black P75D GI40R010 13
75x75 cm

Stonetech Black Soft P75F GI40R020 13
75x75 cm

Stonetech Black 2ØMM Clase3/R11/A+B+C P75G GI40R000 12
75x75 cm



Stonetech Gráfico P64D GI44200J 15
60x60 cm

Stonetech Gráfico 2ØMM Clase3/R11/A+B+C P64G GI44201J 12
60x60 cm



Stonetech Black P64D GI44200K 15
60x60 cm

Stonetech Black 2Ø MM Clase3/R11/A+B+C P64G GI442000 12
60x60 cm



Stonetech Gráfico P34D GI40502J 30
30x60 cm



Stonetech Black P34D GI190501K 30
30x60 cm



Rounded edge skirting 8x60 | Rodapié romano 8x60 S280
Gráfico GI4RQ00J Black GI4RQ000



Step 30x60 | Peldaño simple 30x60 S500
Gráfico GI40500J Black GI405000



Double Step 30x60 | Peldaño doble 30x60 S650
Gráfico GI40501J Black GI405010



Step 60x60 20MM | Peldaño simple 60x60 20MM S610
Gráfico GI40503J Black GI405020



Step 75x75 20MM | Peldaño simple 75x75 20MM S670
Black GI40R00J



WALL TILES | TERMAE WHITE 25X50, LISTELO TERMAE WHITE 8,6X25, BULLNOSE WHITE 5X25

TERMAE 50X50 | 33x33

GLAZED PORCELAIN FLOOR TILES | PAVIMENTO PORCELÁNICO ESMALTADO | GRÉS CÉRAME ÉMAILLÉ | GLASIERTE FEINSTEINZEUG BODENFLIESEN

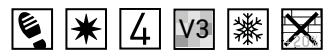

Termae White
50x50 cm GHS13000
P50C

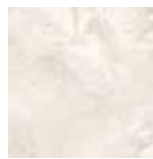

Termae White
33x33 cm GHS08000
P33C



Termae Grey
50x50 cm GHS13010
P50C



Termae Grey
33x33 cm GHS08010
P33C



Termae Beige
50x50 cm GHS13001
P50C

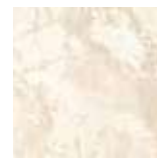

Termae Beige
33x33 cm GHS08011
P33C

25x50 10" x20" TERMAE



WHITE BODY WALL TILES | REVESTIMIENTO PASTA BLANCA | FAÏENCE PÂTE BLANCHE | WEISSSCHERBIGE WANDFLIESEN



Listelo Termae White
8,6x25 cm KHS4N000 S320



Listelo Termae Grey
8,6x25 cm KHS4N002 S320



Listelo Termae Beige
8,6x25 cm KHS4N001 S320



Termae White
25x50 cm KHSTP000 R25D



Termae Grey
25x50 cm KHSTP002 R25D



Termae Beige
25x50 cm KHSTP001 R25D



Termae Concept White
25x50 cm KHSTP010 R25G



Termae Concept Grey
25x50 cm KHSTP012 R25G



Termae Concept Beige
25x50 cm KHSTP011 R25G



Mosaico Termae White
33x33 cm GHS11010 Y300



Mosaico Termae Grey
33x33 cm GHS08002 Y300



Mosaico Termae Beige
33x33 cm GHS08001 Y300

Bullnose 5x25 Bullnose 5x25	White		Grey	S120
	Beige	GHSK5000 GHSK5001	GHSK5002	

PACKING LIST

formato/size	artículo/item	pzs-cj/pcs-box	m²/cj/box	kg/cj/box	cj/box/epl	m²/epl	kg/epl
25x50/10" x20"	Base / Concept	11	1,38	21,78	36	49,68	807,08
8,6x25/3,4" x10"	Listelo	18	0,39	7,38	150	58,05	1130,00
5x25/2" x10"	Bullnose	22	0,28	3,30	150	41,25	551,00
33x33/13" x13"	Mosaico	10	1,09	19,00	36	39,24	707,00
50x50/20" x20"	Base	4	1,00	20,52	36	36,00	761,72
33x33/13" x13"	Base	11	1,21	22,55	48	58,08	1105,4



WALL TILES | THAI BLANCO 25X70, THAI NEGRO 25X70, LISTELO KALA NEGRO 11,8X70, LISTELO KALA NEGRO 3,8X70
FLOOR TILES | MATCH NEGRO 50X50

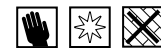

25x70
10" x 28" **THAI**

WHITE BODY WALL TILES

REVESTIMIENTO PASTA BLANCA

FAIÈNCE PÂTE BLANCHE

WEISSSCHERBIGE WANDFLIESEN



Thai Blanco
25x70 cm

R27C
KTYZA000



Listelo Kala Negro
11,8x70 cm

S500
KTYCROOK



Listelo Kala Negro
3,8x70 cm

S380
KTY3500K



Thai Negro
25x70 cm

R27D
KTYZA00K



Listelo Flora (set de 2 pzs)
11,8x70 cm

S540
KTYCROON

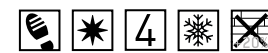

50X50
20" X 20" **MATCH**

GLAZED PORCELAIN FLOOR TILES

PAVIMENTO PORCELÁNICO ESMALTADO

GRÈS CÉRAME ÉMAILLÉ

GLASIERTE FEINSTEINZEUG BODENFLIESEN



Match Negro P50D
50x50cm GQ41301K

Rounded edge skirting 8x50 | Rodapié romano 8x50 S150
Negro GQ4VP01K

PACKING LIST

formato/size	artículo/item	pzs-cj/pcs-box	m ² cj/box	kg/cj/box	cj/box/epl	m ² /epI	kg/epI
25x70/10" x 28"	Base	7	1,23	21,35	42	51,66	919,70
11,8x70/4,6" x 27,6"	Listelo	4	0,33	6,32	80	26,43	528,60
3,8x70/1,5" x 28"	Listelo	4	0,11	2,12	144	15,32	328,28
50x50/20" x 20"	Base	4	1,00	20,52	36	36,00	761,72
8x50/3" x 20"	Rodapié	10	0,40	9,60	120	48,00	1175,00

UPTOWN

WALL TILE | UPTOWN CONCEPT BEIGE 150X37
FLOOR TILE | UPTOWN BEIGE 150X75



WALL TILE | UPTOWN CONCEPT WHITE 150X37, UPTOWN CONCEPT GREY 30X90
FLOOR TILE | UPTOWN GREY 150X75



FLOOR TILE | UPTOWN GREY 150X75



Natural: Clase I | R9 | A
 Antislip: Clase 3 | R10 | A+B+C
 2Ø MM: Clase 3 | R11 | A+B+C



Uptown White
150x75 cm

P575D
GJMZZ000 9



Uptown White
75x75 cm

P75C
GJM0R000 15

Uptown White Antislip
75x75 cm

Clase3/R10/A+B+C P75E
GJM0R050 15

Uptown White 2ØMM
75x75 cm

Clase3/R10/A+B+C P75G
GJM0R100 15



Uptown Modul White
75x75 cm

P75E
GJM0R070 8



Uptown White
150x37 cm

P537D
GJM5F000 18



Uptown White
60x60 cm

P64C
GJM42000 18

Uptown White 2ØMM
60x60 cm

Clase3/R10/A+B+C P64G
GJM42010 12

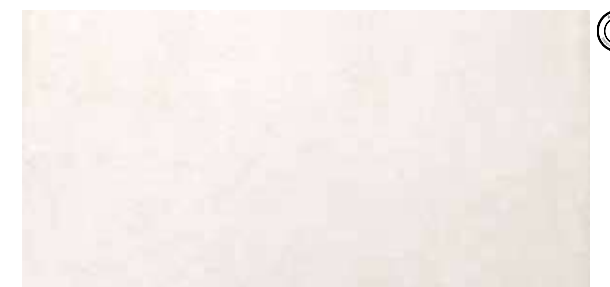

Uptown White
37x75 cm

P37C
GJM0C000 30

Uptown White Antislip
37x75 cm

Clase3/R10/A+B+C P37E
GJM0C100 30

CL
CONVENIENT LARGE



Mosaico Uptown White
30x30 cm GJM04000 Y300



Natural: Clase I | R9 | A
 Antislip: Clase 3 | R10 | A+B+C
 2Ø MM: Clase 3 | R11 | A+B+C

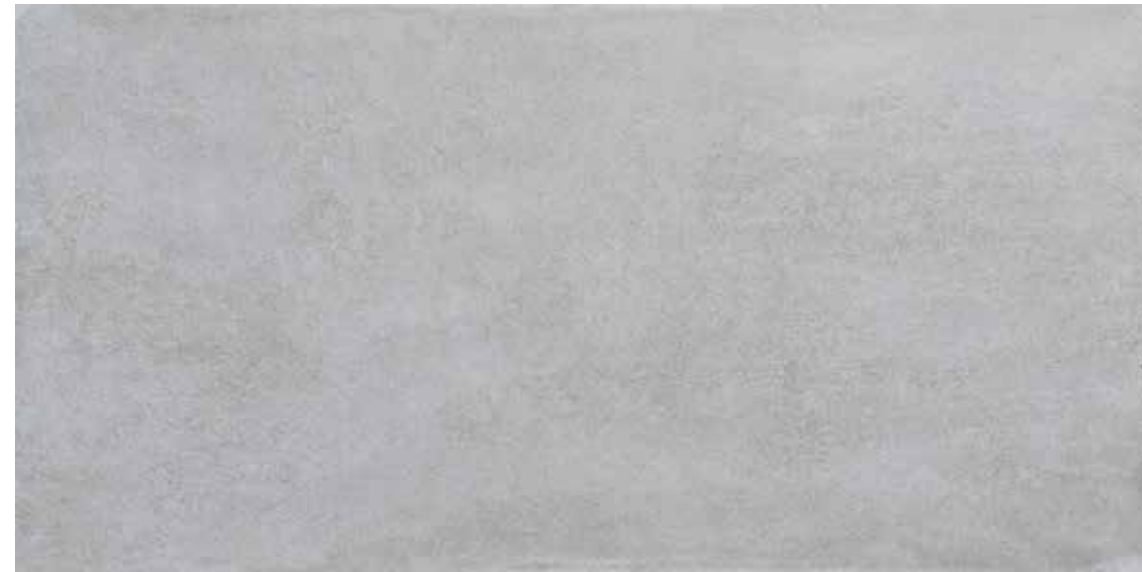

Uptown Grey
150x75 cm

P575D
GJMZZ010 9

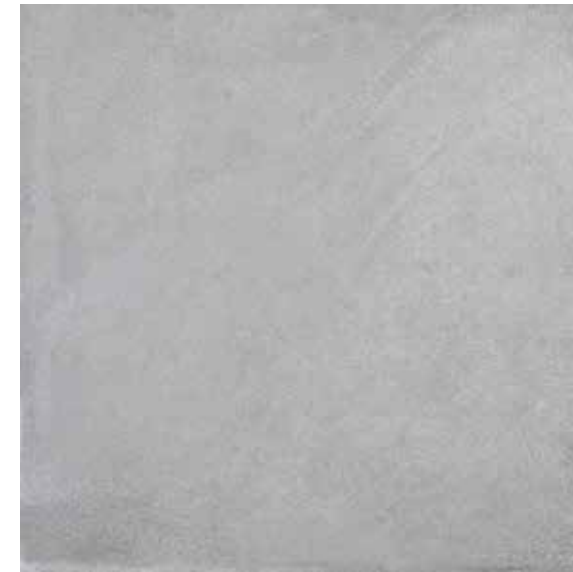

Uptown Grey
75x75 cm

P75D
GJM0R020 15

Uptown Grey Antislip Clase3/R10/A+B+C
75x75 cm

P75E
GJM0R060 15

Uptown Grey 2ØMM Clase3/R10/A+B+C
75x75 cm

P75G
GJM0R110 15



Uptown Modul Grey
75x75 cm

P75E
GJM0R080 8



Uptown Grey
150x37 cm

P537D
GJM5F010 18



Uptown Grey
60x60 cm

P64D
GJM42002 18

Uptown Grey 2ØMM Clase3/R10/A+B+C
60x60 cm

P64G
GJM42020 12



Uptown Grey
37x75 cm

P37D
GJM0C020 30

Uptown Grey Antislip Clase3/R10/A+B+C
37x75 cm

P37E
GJM0C090 30

CL
CONVENIENT LARGE

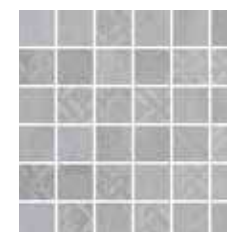

Mosaico Uptown Grey
30x30 cm GJM04010 Y300



Natural: Clase I | R9 | A
 Antislip: Clase 3 | R10 | A+B+C
 2Ø MM: Clase 3 | R11 | A+B+C



Uptown Beige
150x75 cm

P575D
GJMZZ001 9



Uptown Beige
75x75 cm

Uptown Beige Antislip
75x75 cm

Uptown Beige 2ØMM
75x75 cm

P75C
GJM0R010 15

P75E
GJM0R001 15

P75G
GJM0R021 15



Uptown Modul Beige
75x75 cm

P75E
GJM0R011 8



Uptown Beige
150x37 cm

P537D
GJM5F001 18



Uptown Beige
60x60 cm

Uptown Beige 2ØMM
Clase3/R10/A+B+C
60x60 cm

P64C
GJM42001 18

P64G
GJM42011 12



Uptown Beige
37x75 cm

Uptown Beige Antislip
Clase3/R10/A+B+C
37x75 cm

P37C
GJM0C010 30

P37E
GJM0C021 30

CL
CONVENIENT LARGE



Mosaico Uptown Beige
30x30 cm GJM04001 Y300

UPTOWN 75x75 | 37x75 | 60x60

30" x 30" | 15" x 30" | 24" x 24"



COLOURED BODY PORCELAIN FLOOR TILES | PAVIMENTO PORCELÁNICO COLOREADO
GRES CERAME COLORE | DURCHGEFÄRBT E FEINSTEINZEUGBODENFLIESEN

Natural: Clase I | R9 | A
Antislip: Clase 3 | RI0 | A+B+C



Uptown Black
75x75 cm

P75D
GJM0R030 15

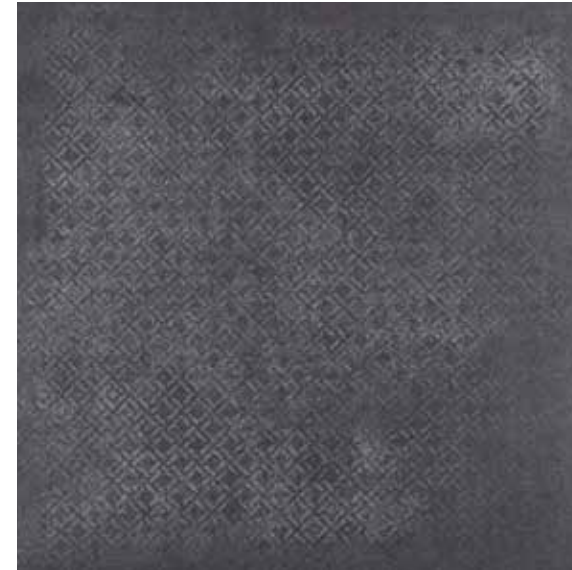

Uptown Modul Black
75x75 cm

P75E
GJM0R090 8



Uptown Black
60x60 cm

P64D
GJM4200K 18



Uptown Black
37x75 cm

P37D
GJM0R040 30



Mosaico Uptown Black
30x30 cm GJM04020 Y300



WALL TILE | UPTOWN BLACK 75X75
FLOOR TILE | UPTOWN GREY 75X75

Rounded edge skirting 8x60 Rodapié romano 8x60	White	GJMRQ000	Grey	GJMRQ010	S280	Step (SR) 150x37 Peldaño simple (SR) 150x37	White	GJMSF050	Beige	GJMSF021	S690	Double Step 150x37 Peldaño doble 150x37	White	GJMSF070	Beige	GJMSF031	S750
	Beige	GJMRQ001	Black	GJMRQ020			Grey	GJMSF040			Grey		GJMSF060				
Rounded edge skirting 8x75 Rodapié romano 8x75	White	GJM3E000	Grey	GJM3E010	S290	Step 30x60 Peldaño simple 30x60	White	GJM05000	Grey	GJM05010	S500	Double Step 30x60 Peldaño doble 30x60	White	GJM05030	Grey	GJM05040	S650
	Beige	GJM3E001	Black	GJM3E020			Beige	GJM05001	Black	GJM05020			Beige	GJM05011	Black	GJM05050	
Step 37x75 Peldaño simple 37x75	White	GJM05000	Grey	GJM05010	S560	Step 37x75 Antislip Peldaño simple 37x75 Antislip	White	GJM05000	Grey	GJM05010	S560	Double Step 37x75 Peldaño doble 37x75	White	GJM05030	Grey	GJM05040	S690
	Beige	GJM05001	Black	GJM05020			Beige	GJM05011	Black	GJM05020			Beige	GJM05030	Black	GJM05050	
Step 37x75 Antislip Peldaño simple 37x75 Antislip	White	GJM05000	Grey	GJM05010	S560	Step 37x75 Antislip Peldaño simple 37x75 Antislip	White	GJM05000	Grey	GJM05010	S560	Double Step 37x75 Antislip Peldaño doble 37x75 Antislip	White	GJM05030	Grey	GJM05040	S690
	Beige	GJM05001	Black	GJM05020			Beige	GJM05011	Black	GJM05020			Beige	GJM05030	Black	GJM05050	
Step 37x75 Antislip Peldaño simple 37x75 Antislip	White	GJM05000	Grey	GJM05010	S560	Step 37x75 Antislip Peldaño simple 37x75 Antislip	White	GJM05000	Grey	GJM05010	S560	Double Step 37x75 Antislip Peldaño doble 37x75 Antislip	White	GJM05030	Grey	GJM05040	S690
	Beige	GJM05001	Black	GJM05020			Beige	GJM05011	Black	GJM05020			Beige	GJM05030	Black	GJM05050	
Step 37x75 Antislip Peldaño simple 37x75 Antislip	White	GJM05000	Grey	GJM05010	S560	Step 37x75 Antislip Peldaño simple 37x75 Antislip	White	GJM05000	Grey	GJM05010	S560	Double Step 37x75 Antislip Peldaño doble 37x75 Antislip	White	GJM05030	Grey	GJM05040	S690
	Beige	GJM05001	Black	GJM05020			Beige	GJM05011	Black	GJM05020			Beige	GJM05030	Black	GJM05050	
Step 37x75 Antislip Peldaño simple 37x75 Antislip	White	GJM05000	Grey	GJM05010	S560	Step 37x75 Antislip Peldaño simple 37x75 Antislip	White	GJM05000	Grey	GJM05010	S560	Double Step 37x75 Antislip Peldaño doble 37x75 Antislip	White	GJM05030	Grey	GJM05040	S690
	Beige	GJM05001	Black	GJM05020			Beige	GJM05011	Black	GJM05020			Beige	GJM05030	Black	GJM05050	
Step 37x75 Antislip Peldaño simple 37x75 Antislip	White	GJM05000	Grey	GJM05010	S560	Step 37x75 Antislip Peldaño simple 37x75 Antislip	White	GJM05000	Grey	GJM05010	S560	Double Step 37x75 Antislip Peldaño doble 37x75 Antislip	White	GJM05030	Grey	GJM05040	S690
	Beige	GJM05001	Black	GJM05020			Beige	GJM05011	Black	GJM05020			Beige	GJM05030	Black	GJM05050	
Step 37x75 Antislip Peldaño simple 37x75 Antislip	White	GJM05000	Grey	GJM05010	S560	Step 37x75 Antislip Peldaño simple 37x75 Antislip	White	GJM05000	Grey	GJM05010	S560	Double Step 37x75 Antislip Peldaño doble 37x75 Antislip	White	GJM05030	Grey	GJM05040	S690
	Beige	GJM05001	Black	GJM05020			Beige	GJM05011	Black	GJM05020			Beige	GJM05030	Black	GJM05050	
Step 37x75 Antislip Peldaño simple 37x75 Antislip	White	GJM05000	Grey	GJM05010	S560	Step 37x75 Antislip Peldaño simple 37x75 Antislip	White	GJM05000	Grey	GJM05010	S560	Double Step 37x75 Antislip Peldaño doble 37x75 Antislip	White	GJM05030	Grey	GJM05040	S690
	Beige	GJM05001	Black	GJM05020			Beige	GJM05011	Black	GJM05020			Beige	GJM05030	Black	GJM05050	
Step 37x75 Antislip Peldaño simple 37x75 Antislip	White	GJM05000	Grey	GJM05010	S560	Step 37x75 Antislip Peldaño simple 37x75 Antislip	White	GJM05000	Grey	GJM05010	S560	Double Step 37x75 Antislip Peldaño doble 37x75 Antislip	White	GJM05030	Grey	GJM05040	S690
	Beige	GJM05001	Black	GJM05020			Beige	GJM05011	Black	GJM05020			Beige	GJM05030	Black	GJM05050	
Step 37x75 Antislip Peldaño simple 37x75 Antislip	White	GJM05000	Grey	GJM05010	S560	Step 37x75 Antislip Peldaño simple 37x75 Antislip	White	GJM05000	Grey	GJM05010	S560	Double Step 37x75 Antislip Peldaño doble 37x75 Antislip	White	GJM05030	Grey	GJM05040	S690
	Beige	GJM05001	Black	GJM05020			Beige	GJM05011	Black	GJM05020			Beige	GJM05030	Black	GJM05050	
Step 37x75 Antislip Peldaño simple 37x75 Antislip	White	GJM05000	Grey	GJM05010	S560	Step 37x75 Antislip Peldaño simple 37x75 Antislip	White	GJM05000	Grey	GJM05010	S560	Double Step 37x75 Antislip Peldaño doble 37x75 Antislip	White	GJM05030	Grey	GJM05040	S690
	Beige	GJM05001	Black	GJM05020			Beige	GJM05011	Black	GJM05020			Beige	GJM05030	Black	GJM05050	
Step 37x75 Antislip Peldaño simple 37x75 Antislip	White	GJM05000	Grey	GJM05010	S560	Step 37x75 Antislip Peldaño simple 37x75 Antislip	White	GJM05000	Grey	GJM05010	S560	Double Step 37x75 Antislip Peldaño doble 37x75 Antislip	White	GJM05030	Grey	GJM05040	S690
	Beige	GJM05001	Black	GJM05020			Beige	GJM05011	Black	GJM05020			Beige	GJM05030	Black	GJM05050	
Step 37x75 Antislip Peldaño simple 37x75 Antislip	White	GJM05000	Grey	GJM05010	S560	Step 37x75 Antislip Peldaño simple 37x75 Antislip	White	GJM05000	Grey	GJM05010	S560	Double Step 37x75 Antislip Peldaño doble 37x75 Antislip	White	GJM05030	Grey	GJM05040	S690
	Beige	GJM05001	Black	GJM05020			Beige	GJM05011	Black	GJM05020			Beige	GJM05030	Black	GJM05050	
Step 37x75 Antislip Peldaño simple 37x75 Antislip	White	GJM05000	Grey	GJM05010	S560	Step 37x75 Antislip Peldaño simple 37x75 Antislip	White	GJM05000	Grey	GJM05010	S560	Double Step 37x75 Antislip Peldaño doble 37x75 Antislip	White	GJM05030	Grey	GJM05040	S690
	Beige	GJM05001	Black	GJM05020			Beige	GJM05011	Black	GJM05020			Beige	GJM05030	Black	GJM05050	
Step 37x75 Antislip Peldaño simple 37x75 Antislip	White	GJM05000	Grey	GJM05010	S560	Step 37x75 Antislip Peldaño simple 37x75 Antislip	White	GJM05000	Grey	GJM05010	S560	Double Step 37x75 Antislip Peldaño doble 37x75 Antislip	White	GJM05030	Grey	GJM05040	S690
	Beige	GJM05001	Black	GJM05020			Beige	GJM05011	Black	GJM05020			Beige	GJM05030	Black	GJM05050	
Step 37x75 Antislip Peldaño simple 37x75 Antislip	White	GJM05000	Grey	GJM05010	S560	Step 37x75 Antislip Peldaño simple 37x75 Antislip	White	GJM05000	Grey	GJM05010	S560	Double Step 37x75 Antislip Peldaño doble 37x75 Antislip	White	GJM05030	Grey	GJM05040	S690
	Beige	GJM05001	Black	GJM05020			Beige	GJM05011	Black	GJM05020			Beige	GJM05030	Black	GJM05050	
Step 37x75 Antislip Peldaño simple 37x75 Antislip	White	GJM05000	Grey	GJM05010	S560	Step 37x75 Antislip Peldaño simple 37x75 Antislip	White	GJM05000	Grey	GJM05010	S560	Double Step 37x75 Antislip Peldaño doble 37x75 Antislip	White	GJM05030	Grey	GJM05040	S690
	Beige	GJM05001	Black	GJM05020			Beige	GJM05011	Black	GJM05020			Beige	GJM05030	Black	GJM05050	

PACKING LIST

formato/size	artículo/item	pzs-cj/pcs-box	m² cj/box	kg/cj/box	cj/box/epl	m²/epl	kg/epl
150x75/60"x30"	Base	1	1,12	26,80	48	53,76	1309,40
150x37/60"x15"	Base	2	1,12	26,80	50	56,00	1363,00
75x75/30"x30"	Base / Antislip / Modul	2	1,13	24,62	42	47,46	1057,04
75x75/30"x30"	20 MM	1	0,56	24,91	42	23,52	1069,22
60x60/24"x24"	Base	3	1,08	22,53	40	43,20	924,20
60x60/24"x24"	20 MM	2	0,72	31,72	32	23,04	1038,04
37x75/15"x30"	Base / Antislip	4	1,13	24,24	48	54,24	1186,52
30x30/12"x12"	Mosaico	11	1,00	20,46	36	36,00	759,56
150x37/60"x15"	Peldaño	2	1,11	26,80	Please ask for information / Consulte información		
150x37/60"x15"	Peldaño Doble	2	1,11	26,80	Please ask for information / Consulte información		
8x60/3"x24"	Rodapié	10	0,48	11,30	80	38,40	943,00
30x60/12"x24"	Peldaño	6	1,08	20,58	Please ask for information / Consulte información		
30x60/12"x24"	Peldaño Doble	2	0,36	13,28	Please ask for information / Consulte información		
8x75/3"x30"	Rodapié	10	0,60	12,90	80	48,00	1055,00
37x75/12"x24"	Peldaño Base / Antislip	4	1,11	24,24	Please ask for information / Consulte información		
37x75/12"x24"	Peldaño Doble Base / Antislip	2	0,56	12,12	Please ask for information / Consulte información		

UPTOWN



WALL TILE | UPTOWN WHITE 150X37, UPTOWN CONCEPT GRIS 150X37
FLOOR TILE | UPTOWN GRIS 150X75



UPTOWN

WALL TILE | UPTOWN CONCEPT WHITE 150X37



WALL TILE | UPTOWN CONCEPT WHITE 150X37
FLOOR TILE | UPTOWN WHITE 150X75



Uptown White
150x37 cm

P537D
GJM5F000 18



Uptown Concept White
150x37 cm

P537G
GJM5T000 12



Uptown Grey
150x37 cm

P537D
GJM5F010 18



Uptown Concept Grey
150x37 cm

P537G
GJM5F020 12



Uptown Beige
150x37 cm

P537D
GJM5F001 18



Uptown Concept Beige
150x37 cm

P537G
GJM5F011 12

CL
CONVENIENT LARGE

PACKING LIST

formato/size	artículo/item	pzs-cj/pcs-box	m²cj/box	kg/cj/box	cj/box/epl	m²/epl	kg/epl
150x37/60"x15"	Base / Concept	2	1,12	26,80	50	56,00	1363,00

UPTOWN



WALL TILE | UPTOWN WHITE 30X90, UPTOWN CONCEPT WHITE 30X90,
UPTOWN CONCEPT GREY 30X90
FLOOR TILE | UPTOWN GREY 75X75, UPTOWN MODUL GREY 75X75



WALL TILE | UPTOWN CONCEPT BEIGE 30X90



WALL TILE | UPTOWN BEIGE 30X90, PERFIL ACERO BRONCE 1,5X90
FLOOR TILE | UPTOWN BEIGE 60X60



Uptown White
30x90 cm

R90D
KJMPG000



Uptown Beige
30x90 cm

R90D
KJMPG001



Uptown Concept White
30x90 cm

R90G
KJMPG010



Uptown Concept Grey
30x90 cm

R90G
KJMPG020



Uptown Concept Beige
30x90 cm

R90G
KJMPG011



Uptown Art White
30x90 cm

R90G
KJMPG030



Uptown Art Grey
30x90 cm

R90G
KJMPG040

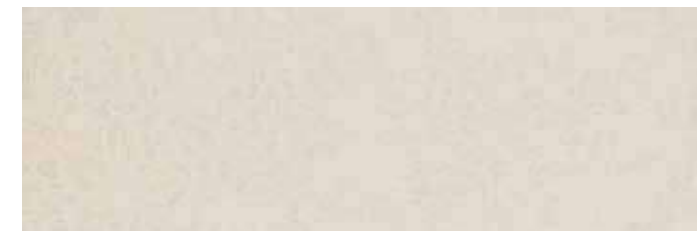

Uptown Art Beige
30x90 cm

R90G
KJMPG021



Perfil Acero Plata
1,5x90 cm

S330
K432L00L



Perfil Acero Bronce
1,5x90 cm

S330
K432L00M

PACKING LIST

formato/size	artículo/item	pzs-cj/pcs-box	m²cj/box	kg/cj/box	cj/box/epl	m²/epl	kg/epl
30x90/12"x36"	Base / Concept / Art	4	1,08	18,84	51	55,08	983,84
4,8x30/1,9"x12"	Listelo	11	0,16	3,30	110	17,42	386,00
7x30/2,7"x12"	Listelo	12	0,25	5,04	90	22,68	476,60
12,5x30/4,9"x12"	Zócalo	6	0,22	4,80	110	24,75	551,00
1,5x90/0,8"x36"	Perfil	6	0,08	0,90	336	27,22	325,40



WALL TILE | UPTOWN WHITE 30X90, UPTOWN ART GREY 30X90, LISTELO TOUSSETE GREY 4,8X30, ZÓCALO TOUSSETE GREY 12,5X30
 FLOOR TILE | UPTOWN WHITE 75X75



30x90 12" x 36" **UPTOWN**

WHITE BODY WALL TILES

REVESTIMIENTO PASTA BLANCA

FAIÈNCE PÂTE BLANCHE

WEISSSCHERBIGE WANDFLIESEN



Uptown White
 30x90 cm R90D
 KJMPPG000

14



Listelo Toussete White
 4,8X30 cm S460
 KJM0N000



Listelo Uptown Art Silver
 7X30 cm S320
 KJM0N00L



Uptown White
 30x90 cm R90D
 KJMPPG000

14

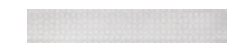

Listelo Toussete Grey
 4,8X30 cm S460
 KJM0N010



Uptown Beige
 30x90 cm R90D
 KJMPPG001

13



Listelo Toussete Beige
 4,8X30 cm S460
 KJM0N001



Listelo Uptown Art Gold
 7X30 cm S320
 KJM0N004



Uptown Art White
 30x90 cm R90G
 KJMPPG030



Zócalo Toussete White
 12,5X30 cm S570
 KJM0N020



Uptown Art Grey
 30x90 cm R90G
 KJMPPG040



Zócalo Piaget Silver
 12,5x30 cm S570
 KJNTB00L



Uptown Art Grey
 30x90 cm R90G
 KJMPPG040



Zócalo Toussete Grey
 12,5X30 cm S570
 KJM0N030



Uptown Art Beige
 30x90 cm R90G
 KJMPPG021



Zócalo Toussete Beige
 12,5X30 cm S570
 KJM0N011



Zócalo Piaget gold
 12,5x30 cm S570
 KJNTB004



25x50
10" x 20" **UPTOWN**

WHITE BODY WALL TILES | REVESTIMIENTO PASTA BLANCA | FAÏENCE PÂTE BLANCHE | WEISSSCHERBIGE WANDFLIESEN



Uptown White R25C
25x50 cm KJMTP000 24



Uptown Grey R25C
25x50 cm KJMTP010 24



Uptown Beige R25C
25x50 cm KJMTP001 24



Uptown Concept White R25G
25x50 cm KJMTP020 9



Uptown Concept Grey R25G
25x50 cm KJMTP030 9



Uptown Concept Beige R25G
25x50 cm KJMTP011 9



Listelo Uptown White S230
4,6x50 cm KJMAV000



Listelo Uptown Grey S230
4,6x50 cm KJMAV002



Listelo Uptown Beige S230
4,6x50 cm KJMAV001



Perfil Acero Plata S260
1,5x50 cm KJQBH00L



Perfil Acero Bronce S260
1,5x50 cm KJQBH00M



50X50
20" X 20" **UPTOWN**

GLAZED PORCELAIN FLOOR TILES | PAVIMENTO PORCELÁNICO ESMALTADO | GRÈS CÉRAME ÉMAILLÉ | GLASIERTE FEINSTEINZEUG BODENFLIESEN



Uptown White P50C
50x50cm GJM13010



Uptown Grey P50C
50x50cm GJM13000



Uptown Beige P50C
50x50cm GJM13001



PACKING LIST

formato/size	artículo/item	pzs-cj/pcs-box	m²cj/box	kg/cj/box	cj/box/epl	m²/epl	kg/epl
25x50/10" x 20"	Base / Concept	11	1,38	23,54	36	49,68	870,44
4,6x50/1,8" x 20"	Listelo	10	0,23	4,00	120	27,60	503,00
50x50/20" x 20"	Base	4	1,00	20,52	36	36,00	761,72
1,5x50/1,8" x 20"	Perfil	6	0,05	0,48	400	18,00	215,00
8x50/3" x 20"	Rodapié	10	0,40	9,60	120	48,00	1175,00

WALL TILE | UPTOWN BEIGE 25X50, UPTOWN CONCEPT BEIGE 25X50
FLOOR TILE | UPTOWN BEIGE 75X75



100x50 | 60x60 | 30x60
 40" x 20" | 24" x 24" | 12" x 24"

URBAN

FULL BODY FLOOR TILES | PAVIMENTO TODO MASA
 PLEINE MASSE | BODENFLIESEN EINE MASSE

Natural: Clase I | R9



Urban Beige
 100x50 cm



P100C
 GA221001

Urban Moka
 100x50 cm

P100D
 GA22100D

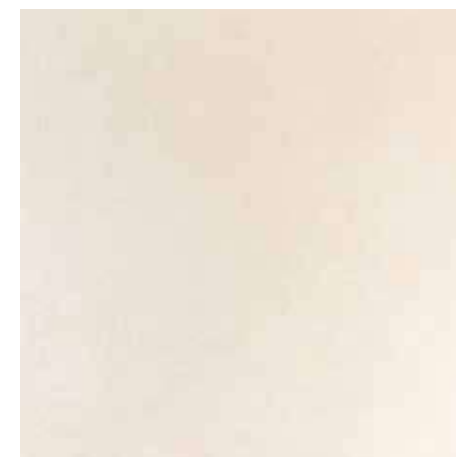

Urban Beige
 60x60 cm

P64C
 GA242001



Urban Beige
 30x60 cm

P34C
 GA205001

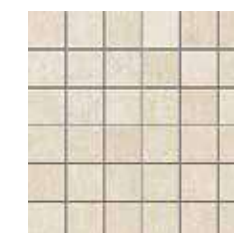

Mosaico Urban Beige
 30x30 cm GA204001
 Y500



Urban Gris
100x50 cm

P100C
GA221002



Urban Gris
60x60 cm

P64C
GA242002

Urban Gris Antislip
Clase3/R11/A+B+C

P64E
GA242012



Urban Gris
30x60 cm

P34C
GA205002

Urban Gris Antislip
Clase3/R11/A+B+C

P34E
GA205012



Mosaico Urban Gris
30x30 cm GA204002
Y500



Urban Grafito
60x60 cm

P64C
GA24200J

Urban Grafito Antislip
Clase3/R11/A+B+C

P64E
GA24201J



Urban Grafito
30x60 cm

P34C
GA20500J

Urban Grafito Antislip
Clase3/R11/A+B+C

P34E
GA20501J

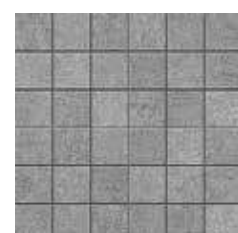

Mosaico Urban Grafito
30x30 cm GA20400J
Y500



Urban Negro
100x50 cm

P100D
GA22100K



Urban Negro
60x60 cm

P64D
GA24200K

Urban Negro Antislip
Clase3/R11/A+B+C

P64E
GA24201K



Urban Negro
30x60 cm

P34D
GA20500K

Urban Negro Antislip
Clase3/R11/A+B+C

P34E
GA20501K

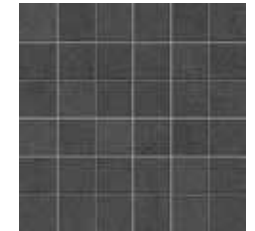

Mosaico Urban Negro
30x30 cm GA20400K
Y500

Rounded edge skirting 8x60 Rodapié roma 8x60 S280			
Beige Grafito	GA2RQ001	Gris Negro	GA2RQ002
	GA2RQ00J		GA2RQ00K

Step 30x60 Peldaño simple 30x60 S500			
Beige Grafito	GA205031	Gris Negro	GA205032
	GA20503J		GA20503K

Double Step 30x60 Peldaño doble 30x60 S650			
Beige Grafito	GA205051	Gris Negro	GA205052
	GA20505J		GA20505K

Step 30x60 Antislip Peldaño simple 30x60 Antislip S500			
Beige Grafito	GA205041	Gris Negro	GA205042
	GA20504J		GA20504K

Double Step 30x60 Antislip Peldaño doble 30x60 Antislip S650			
Beige Grafito	GA205021	Gris Negro	GA205022
	GA20502J		GA20502K

Step 100x50 Peldaño simple 100x50 S600			
Beige Grafito	GA221011	Gris Moka	GA221012
	GA22102K		GA22101D

Double Step 100x50 Peldaño doble 100x50 S720			
Beige Grafito	GA221021	Gris Negro	GA221022
	GA22102J		GA22102K

PACKING LIST

formato/size	artículo/item	pzs-cj/pcs-box	m ² /cj/box	kg/cj/box	cj/box/epl	m ² /ep1	kg/ep1
100x50/40" x 20"	Base	2	1,00	23,60	28	28,00	683,80
60x60/24" x 24"	Base / Antislip	3	1,08	22,53	40	43,20	924,20
30x60/12" x 24"	Base / Antislip	6	1,08	22,32	40	43,20	915,80
30x30/12" x 12"	Mosaico	11	1,00	20,46	36	36,00	759,56
8x60/3" x 24"	Rodapié	10	0,48	11,30	80	38,40	943,00
30x60/12" x 24"	Peldaño Base / Antislip	6	1,08	20,58	Please ask for information / Consulte información		
30x60/12" x 24"	Peldaño Doble Base / Antislip	2	0,36	13,28	Please ask for information / Consulte información		
100x50/40" x 20"	Peldaño	2	1,00	25,20	Please ask for information / Consulte información		
100x50/40" x 20"	Peldaño Doble	2	1,00	28,34	Please ask for information / Consulte información		



WALL TILES | VELVET BLANCO 30X90, VELVET GRAFITO 30X90,
VELVET MODUL BLANCO 30X90
FLOOR TILES | MATCH ANTRAZITA 50X50

MATCH 50X50

20" X20"

GLAZED PORCELAIN FLOOR TILES

PAVIMENTO PORCELÁNICO ESMALTADO

GRÈS CÉRAME ÉMAILLÉ

GLASIERTE FEINSTEINZEUG BODENFLIESEN



Match Antrazita P50D
50x50cm GQ41300K

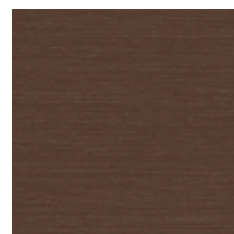

Match Marrón P50D
50x50cm GQ413023

Rounded edge skirting 8x50 | Rodapié roma 8x50 S150
Antrazita GQ4VP00K Marrón GQ4VP013

PACKING LIST

formato/size	artículo/item	pzs-cj/pcs-box	m ² cj/box	kg/cj/box	cj/box/epl	m ² /epl	kg/epl
30x90/12" x36"	Base / Modul	4	1,08	18,84	51	55,08	983,84
30x90/12" x36"	Decor	4	1,08	21,60	12	12,96	282,20
30x30/12" x12"	Malla	9	0,81	15,57	42	34,02	676,94
5,8x90/2,3" x35,4"	Listelo	6	0,31	6,30	56	17,54	375,80
50x50/19,6" x19,6"	Base	4	1,00	20,52	36	36,00	761,72
8x50/3" x20"	Rodapié	10	0,40	9,60	120	48,00	1175,00



30x90
12" x36"

VELVET

WHITE BODY WALL TILES

REVESTIMIENTO PASTA BLANCA

FAÏENCE PÂTE BLANCHE

WEISSSCHERBIGE WANDFLIESEN



Velvet Blanco
30x90 cm

R90D
K36PG000



Velvet Grafito
30x90 cm

R90E
K36PG00J



Velvet Modul Blanco
30x90 cm

R90E
K36PG010



** Decor Bloom Blanco (Set de 2 Piezas)
30x90 cm

S670
G36PGG87



Listelo Bloom Grafito
5,8x90 cm

S530
G360AG89

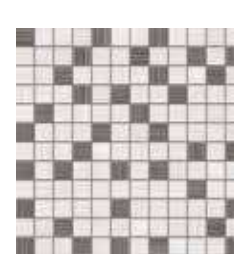

Malla Velvet Grafito
30x30 cm K360400J S550



Velvet Crema
30x90 cm

R90D
K36PG001



Velvet Marrón
30x90 cm

R90E
K36PG003



Velvet Modul Crema
30x90 cm

R90E
K36PG011



** Decor Bloom Crema (Set de 2 Piezas)
30x90 cm

S670
G36PGG88



Listelo Bloom Marrón
5,8x90 cm

S530
G360AG90

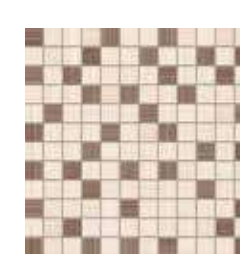

Malla Velvet Marrón
30x30 cm K3604003 S550

VILLAGE

FLOOR TILE | VILLAGE WHITE 18,5X75



100x24,8 | 18,5x75 **VILLAGE**
40" x 10" | 7" x 30"

COLOURED BODY PORCELAIN FLOOR TILES | PAVIMENTO PORCELÁNICO COLOREADO
GRES CERAME COLOREÉ | DURCHGEFÄRBTE FEINSTEINZEUGBODENFLIESEN

Natural: R9



Village White
100x24,8 cm

P125D
GJW44000 24



Village White
18,5x75 cm

P18D
GJWZZ000 44



Village Cement
100x24,8 cm

P125D
GJW44060 24



Village Cement
18,5x75 cm

P18D
GJWZZ020 44



Village Cream
100x24,8 cm

P125D
GJW44010 24



Village Cream
18,5x75 cm

P18D
GJWZZ010 44



Village Oak
100x24,8 cm

P125D
GJW4400D 24



Village Oak
18,5x75 cm

P18D
GJWZZ030 44





Village Dark
100x24,8 cm

P125D
GJW44070 24



Village Dark
18,5x75 cm

P18D
GJWZZ00D 44

	Rounded edge skirting 8x50 Rodapié romano 8x50 S150					Step 100x24,8 Peldaño simple 100x24,8 S600					Double Step 100x24,8 Peldaño doble 100x24,8 S720			
White	GJWVP000	Dark	GJWVP00D	White	GJW44020	Dark	GJW4401D	White	GJW44040	Dark	GJW4402D			
Cement	GJWVP020	Cream	GJWVP010	Cement	GJW44080	Cream	GJW44030	Cement	GJW44100	Cream	GJW44050			
Oak	GJWVP030			Oak	GJW44090			Oak	GJW44110					

PACKING LIST

formato/size	artículo/item	pzs.-cj/pcs.-box	m²cj/box	kg/cj/box	cj/box/epl	m²/epl	kg/epl
100x24,8/40"x10"	Base	3	0,74	17,67	40	29,60	729,80
18,5x75/7"x30"	Base	8	1,11	24,64	48	53,28	1205,72
8x50/3"x20"	Rodapié	10	0,40	9,60	120	48,00	1175,00
100x24,8/40"x10"	Peldaño	3	0,74	22,50	Please ask for information / Consulte información		
100x24,8/40"x10"	Peldaño Doble	2	0,50	12,60	Please ask for information / Consulte información		

FLOOR TILE | VILLAGE CREAM 100X24,8



30x90
12" x 36" **WALL BRICK**

WHITE BODY WALL TILES

REVESTIMIENTO PASTA BLANCA

FAIENCE PÂTE BLANCHE

WEISSSCHERBIGE WANDFLIESEN



Wall Brick White
30x90 cm

R90G
KKHPG000



Wall Brick Old Grey
30x90 cm

R90G
KKHPG000 8



Wall Brick Black
30x90 cm

R90G
KKHPG020



Wall Brick Old Smoke
30x90 cm

R90G
KKHPG030 8



Wall Brick Old Cream
30x90 cm

R90G
KKHPG010 8



Wall Brick Old Cotto
30x90 cm

R90G
KKHPG020 8

Material de rejunte recomendado para la optimización del resultado estético
Recommended grout to maintain the optimal aesthetic result of this range
Référence du joint conseillé pour un résultat esthétique parfait
Empfohlenes Fugenmaterial für die ästhetische Optimierung der Verlegeresultate

- WALL BRICK OLD CREAM 30X90 - Kerakoll luz
- WALL BRICK OLD GREY 30X90 - Kerakoll luz
- WALL BRICK OLD SMOKE 30X90 - Kerakoll perla
- WALL BRICK OLD COTTO 30X90 - Kerakoll perla

PACKING LIST

formato/size	artículo/item	pzs-cj/pcs-box	m ² cj/box	kg/cj/box	cj/box/epl	m ² /ep1	kg/ep1
30x90/12" x 36"	Base	4	1,08	18,84	51	55,08	983,84



100x50
40" x 20" **ZEBRA**

GLAZED PORCELAIN FLOOR TILES | PAVIMENTO PORCELÁNICO ESMALTADO | GRÉS CÉRAME ÉMAILLÉ | GLASIERTE FEINSTEINZEUG BODENFLIESEN

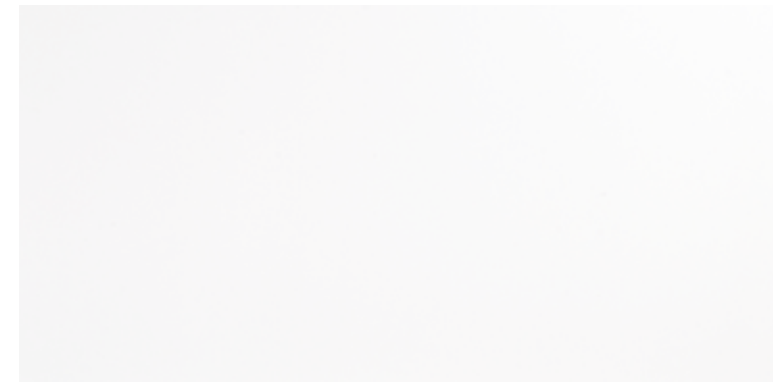

Zebra Blanco
100x50 cm

P100C
GZB21000

PACKING LIST

formato/size	artículo/item	pzs-cj/pcs-box	m ² cj/box	kg/cj/box	cj/box/epl	m ² /epl	kg/epl
100x50/40"x20"	Base	2	1,00	23,60	28	28,00	683,80

WALL TILES | ZEBRA BLANCO 100X50



TECHNICAL INFORMATION INDEX

ÍNDICE DE INFORMACIÓN TÉCNICA | TAUX D'INFORMATION TECHNIQUE | VERZEICHNIS DER TECHNISCHEN INFORMATIONEN

COMPARATIVE AND TECHNICAL CHARACTERISTICS COMPARATIVA Y CARACTERÍSTICAS TÉCNICAS	340
ANTISLIP	342
TILE-LAYING, CLEANING AND CARE RECOMMENDATIONS CONSEJOS DE COLOCACIÓN, LIMPIEZA Y MANTENIMIENTO	344
SPECIAL TILE PIECES PIEZAS ESPECIALES	362
KERABEN 3D	364
CERTIFICATES AND REGULATIONS CERTIFICADOS Y NORMATIVAS	368
TECHNICAL DETAILS DATOS TÉCNICOS	370
PACKING LIST EMBALAJE	376

COMPARATIVE AND TECHNICAL CHARACTERISTICS

COMPARATIVA Y CARACTERÍSTICAS TÉCNICAS | COMPARAISON ET CARACTÉRISTIQUES
TECHNIQUES | GEGENÜBERSTELLUNG UND TECHNISCHE EIGENSCHAFTEN

SUMMARY OF THE INTERVENTIONS ON THE VARIOUS TYPES OF FLOORS COMPARATIVA DE DIFERENTES TIPOS DE SUELO UTILIZADOS

Summary of the interventions on the various types of floors to be expected during the lifetime of the building (40 years), in reference to the physical lifetime of the material.
Comparativa de diferentes tipos de suelo utilizados durante el ciclo de vida de un edificio, teniendo en cuenta las cualidades físicas de los diferentes materiales.

YEAR AÑO	0	2	4	5	8	10	12	14	16	18	20	22	24	26	28	30	32	34	36	38	40	
CERAMIC TILE CERÁMICA																						
SINGLE-FIRED TILE MONOCOCCIÓN																						
TERRACOTTA TILES BARRO COCIDO						•					•					•						
STONEWARE TILES GRES																						
KLINKER																						
NATURAL STONE PIEDRA NATURAL																						
MARBLE MÁRMOL						•					•					•						
GRANITE GRANITO										•									•			
CONGLOMERATES CONGLOMERANTES																						
MARBLE-CEMENT CEMENTO + MÁRMOL							•										•					
MARBLE-RESIN RESINA + MÁRMOL				•				•				•							•			
SILICEOUS RESINS RESINAS SILICIO																						
WOOD MADERA											○										○	
CORK CORCHO										○											○	
RUBBER CAUCHO				○		○		○		○		○		○		○		○		○		○
VINYL VINILO				○		○		○		○		○		○		○		○		○		○
CARPETING ALFOMBRA		•	•	○	•	○	•	•	○	•	○	•	•	○	•	○	•	•	○	•	•	○

● Maintenance | Mantenimiento

○ Renovation | Renovación

Sources: confindustria and the tile council of america

WHY USE CERAMIC TILES? ¿POR QUÉ UTILIZAR CERÁMICA?

		PORCELAIN TILES PORCELÁNICO	MARBLE MÁRMOL	LIMESTONE CALIZA	GRANITE GRANITO	WOOD MADERA	HPL - PLASTIC	ALUMINIUM ALUMINIO	CONCRETE HORMIGÓN
DIMENSIONAL STABILITY ESTABILIDAD DIMENSIONAL	UNE-EN ISO 10545-2	***	***	***	***	***	***	**	**
BENDING STRENGTH RESISTENCIA A LA FLEXIÓN	UNE-EN ISO 10545-4	***	***	***	***	***	***	*	***
RESISTANCE TO FROST AND ICE RESISTENCIA A LA HELADA	UNE-EN ISO 10545-12	***	***	***	***	***	***	***	*
RESISTANCE TO FILTRATION RESISTENCIA A LA FILTRACIÓN	BS 4131	***	**	**	**	**	**	***	*
SURFACE/MASS RATIO RELACIÓN SUPERFICIE / MASA		**	*	*	*	**	**	***	*
RESISTANCE TO MOISTURE EXPANSION RESISTENCIA A LA EXPANSIÓN POR HUMEDAD	UNE-EN ISO 10545-10	***	***	***	*	*	*	**	**
RESISTANCE TO THERMAL EXPANSION RESISTENCIA A LA DILATACIÓN TÉRMICA	UNE-EN ISO 10545-8	***	*	***	***	*	*	*	**
RESISTANCE TO STAINING RESISTENCIA A LAS MANCHAS	UNE-EN ISO 10545-14	***	*	***	*	***	***	**	*
RESISTANCE TO SALINE CORROSION RESISTENCIA A LA CORROSIÓN SALINA	UNE-112017-ISO 9227	***	*	*	**	**	***	***	*
RESISTANCE TO AGING RESISTENCIA AL ENVEJECIMIENTO SOLAR	UNE-EN ISO 11341 (M2, C-A)	***	*	*	**	*	**	**	**

*** High | Excelente

** Medium | Óptimo

* Low | Deficiente

WHITE BODY VS PORCELAIN TILE PASTA BLANCA VS PORCELÁNICO

WHITE BODY | PASTA BLANCA (Grupo BIII)



PORCELAIN TILES | PORCELÁNICO (Grupo BIa - BIb)

White Body | Pasta blanca

White or coloured | Blanco o coloreado

Basic feature: high water absorption capacity | Característica básica alta absorción de agua

Basic feature: low water absorption capacity | Característica básica baja absorción de agua

BIII >10%

BIa <0,5%

BIb 0,6% al 3%

Always glazed | Siempre esmaltada

Glazed | Esmaltado

Non-glazed decorative | No esmaltado decorado

High-tech - Full-body | Técnico / Todo Masa

Gloss or Matt | Brillo o Mate

Gloss or Matt | Brillo o Mate

Cannot be polished | No se puede pulir

Polished | Pulido

Lappato

Antislip

For use on interior walls only |
Uso exclusivo paredes de interiores

For use on interiors, exteriors, façades, walls and floors |
Uso interiores, exteriores, fachadas, paredes y suelos





ANTISLIP

SLIP RESISTANCE CATEGORIES FOR RISK ENVIRONMENTS
 CATEGORÍAS DE RESISTENCIA AL DESPLAZAMIENTO PARA AMBIENTES DE RIESGO
 CATEGORIE DE RÉSISTANCE AU GLISSEMENT POUR ESPACE À RISQUE
 RUTSCHHEMMUNGSKATEGORIEN

rating clase classement bewertung	angle ángulos de inclinación angles d'inclinaison neigungswinkel	field of application campos de aplicación domaines d'utilisation anwendungsbereich
--	---	---

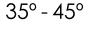

UNE-ENV 12633

SLIP RESISTANCE | RESISTENCIA AL DESLIZAMIENTO | RESISTENCE ANTISLIP | BESTIMMUNG DER RUTSCHHEMMUNG MIT SCHUHWERK

CLASE 0	< 15° 	Dry indoor areas without slope Zonas interiores secas sin pendiente Espaces intérieurs secs sans pente Trockene Innenbereiche ohne Gefälle
CLASE 1	15° - 35° 	Dry indoor areas with a slope of less than 6% Zonas interiores secas con pendiente menor que el 6% Espaces intérieurs secs avec une pente inférieure à 6% Trockene Innenbereiche mit einer Neigung von weniger als 6%
CLASE 2	35° - 45° 	Indoor areas subject to moisture with a slope of less than 6% Zonas interiores húmedas con pendiente menor que el 6% Espaces intérieurs soumis à l'humidité avec une pente inférieure à 6% Nassbereiche mit einer Neigung von weniger als 6%
CLASE 3	< 45° 	Outdoor areas Zonas exteriores Espaces extérieurs Außenbereiche

DIN 51097

ANTISLIP PROPERTIES WET-LOADED BEREFOOT AREAS | PROPIEDADES ANTIDESLIZAMIENTO A PIE DESCALZO | CLASSEMENT ANTISLIP POUR PIE DECHAUSSÉ BESTIMMUNG DER RUTSCHHEMMUNG IM NASSBELASTETEN BARFUSSBEREICH

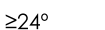
A	≥12° 	Dressing rooms, walkways with bare feet, etc. Vestuarios, zonas de paso con pies descalzos, etc. Vestiaires, zone de passage pieds nus, etc. Umkleideräume, usw.
A+B	≥18° 	Shower enclosures, swimming pool decks, etc. Duchas, bordes de piscina, etc. Douches, bords des piscines, etc. Duschräume, Beckenumrandungen, usw.
A+B+C	≥24° 	Sloping swimming pool decks, submerged stairs, etc. Bordes de piscina con pendiente, escaleras sumergidas, etc. Bords de piscine pentue, escalier immergé, etc. Durchschreitebecken, usw.

DIN 51130

SLIP RESISTANCE | RESISTENCIA AL DESLIZAMIENTO | RESISTENCE ANTISLIP | BESTIMMUNG DER RUTSCHHEMMUNG MIT SCHUHWERK

R9	6° - 10° 	Common areas (offices, schools, etc...) Zonas comunes de locales (colegios, oficinas, etc...) Parties communes (écoles, bureaux, etc....) Gemeinschaftsräume (Schulen, Büros usw...)
R10	10° - 19° 	Bathrooms, warehouses, garages, kitchens of restaurants, etc. Baños, almacenes, garajes, cocinas de locales públicos, etc. Toilettens magasins, garages cuisines d'établissements publics, etc. Toiletten, Lagerhallen, Garagen, Grossküchen, usw.
R11	19° - 27° 	Outdoor transit areas (pavements, etc...) Zonas de tránsito exterior (aceras, etc...) Zones de transit externe (trottoirs, etc....) Ladeneingänge, Aussentreppen, usw.
R12	27° - 35° 	Industrial kitchens (restaurants, hotels, etc...) Cocinas industriales (Restaurants, hoteles, etc...) Cuisines industrielles (restaurants, hôtels, etc...) Industrieküchen (Restaurants, Hotels, usw.)

ANTISLIP

SHOELESS TECHNOLOGY



We wish to introduce the new ANTISLIP SHOELESS TECHNOLOGY. An innovative and improved version of an antislip porcelain tile, with a roughness unnoticeable to touch.

Te presentamos el nuevo ANTISLIP SHOELESS TECHNOLOGY. Una nueva y mejorada versión de porcelánico antideslizante C3 con una rugosidad imperceptible al tacto.



**ANTISLIP EXTRA-SILKY
C3 EXTRA SUAVE**

The new technology includes an antislip finish for outdoor surfaces with an extra-silky texture that meets standards in terms of slip-resistance.

La nueva tecnología incorpora un acabado antideslizante para exterior con textura extra sedosa, que cumple con los requisitos del CTE.



**EASY TO CLEAN
FÁCIL LIMPIEZA**

Cleaning ANTISLIP SHOELESS TECHNOLOGY is really easy. All types of cleaning agents can be used. In view of its low surface roughness, the cleaning is easier.

La limpieza del nuevo ANTISLIP SHOELESS TECHNOLOGY se realiza con facilidad, pudiendo aplicar todo tipo de agentes de limpieza. Su escasa rugosidad superficial hace que la limpieza sea más cómoda.



**HOMOGENOUS FINISH
ACABADO HOMOGÉNEO**

The new finish maintains the designs and colours of the natural finish, thanks to its high level of transparency, which allows it to create spaces with completely homogenous design.

El nuevo acabado respeta los diseños y colores del acabado natural de las piezas gracias a su elevada transparencia permitiendo crear espacios totalmente homogéneos.



**CERTIFIED
CERTIFICADO**

All of the new properties of this new ANTISLIP SHOELESS TECHNOLOGY have been tested and verified by Spanish

Ceramic Technology Institute. Todas las propiedades del nuevo ANTISLIP SHOELESS TECHNOLOGY han sido ensayadas y verificadas por el Instituto de Tecnología Cerámica (ITC).

TILE-LAYING, CLEANING AND CARE RECOMMENDATIONS

CONSEJOS DE COLOCACIÓN, LIMPIEZA Y MANTENIMIENTO | CONSEILS DE POSE, NETTOYAGE ET ENTRETIEN | TIPPS FÜR DIE VERLEGUNG, REINIGUNG UND PFLEGE

1 CHECK THE PRODUCT AGAINST THE DELIVERY NOTE COMPRUEBA EL ALBARÁN Y VERIFICA EL PRODUCTO | VÉRIFIER LE BON DE LIVRAISON ET LE PRODUIT | ÜBERPRÜFEN SIE LIEFERSCHEIN UND PRODUKT

It is important to check that the product you have received corresponds to what you ordered. To facilitate this process, we provide a series of references on the tops of the boxes so you can verify the following information:

- **Model:** The basic identification of all our products. This gives the product name as well as its colour.
- **Format:** The size of the tiles. This figure is given in both centimetres and inches.
- **Approximate m2:** The approximate surface area that the contents of the box will cover.
- **Kilos:** The weight of the box.
- **No. of files:** The number of files in the box.
- **Calibre:** The grouping of the content of the box by size.
- **Tone:** The colour shade of the set of files you have been sent.
- **EAN Code:** An exclusive product code that consists of a series of bars that can be read by a scanner to identify the product.
- **Control:** The number that allows us to trace the product.

Il est important de vérifier que le produit céramique reçu correspond à votre bon de commande. Pour faciliter ce processus, une série de références est indiquée sur les emballages de nos produits aux fins de vérification, à savoir :

- **Modèle:** l'élément d'identité de base de chacun de nos produits. Il indique le nom et la couleur du produit.
- **Format:** dimensions des pièces exprimées en centimètres et en pouces.
- **M2 approximatifs:** superficie approximative indiquée sur la caisse.
- **Kilogrammes:** poids de la caisse.
- **Nombre de pièces:** nombre de pièces dans chaque caisse.
- **Calibre:** regroupement du contenu de la caisse selon ses dimensions.
- **Teinte:** il s'agit de la nuance de la couleur qu'ont les carrelages que vous avez reçus.
- **Code EAN:** c'est le code exclusif du produit, représenté par des barres et lisible par le scanner pour permettre son identification.
- **Contrôle:** indicateur numérique qui permet de connaître la traçabilité du produit.

Es importante comprobar que el producto cerámico recibido se corresponde con nuestro pedido de compra. Para facilitar este proceso, especificamos una serie de referencias en las cubiertas de las cajas de nuestros productos para que puedas verificar:

- **Modelo:** El elemento básico de identidad de cada uno de nuestros productos. Indica tanto el nombre como el color del producto.
- **Formato:** Tamaño de las piezas. Lo encontrarás en centímetros y pulgadas
- **M2 aproximados:** superficie aproximada dispuesta en la caja.
- **Kilogramos:** Peso de la caja.
- **Número de piezas:** Número de piezas que incluye la caja.
- **Calibre:** Agrupación del contenido de la caja según su dimensión.
- **Tono:** Se trata del matiz de color que tiene la partida de azulejos que has recibido.
- **Código EAN:** Es un código exclusivo del producto, representado por barras y legibles por escáner, que permite su identificación.
- **Control:** Indicador numérico que nos permite conocer la trazabilidad del producto.

Wichtig ist die Überprüfung, ob das gelieferte Keramikprodukt der Bestellung entspricht. Zur Erleichterung dieses Arbeitsschrittes sind auf der Oberseite der Kartons unserer Produkte eine Reihe von Referenzwerten zum Vergleich angegeben:

- **Modell:** Das grundlegende Identitätsmerkmal aller unserer Produkte. Gibt Namen und Farbe des Produkts an.
- **Format:** Größe der Fliesen. Wird in Zentimetern und Zoll angegeben.
- **Ungefähre M2:** Im Karton enthaltene ungefähre Fläche.
- **Kilogramm:** Gewicht des Kartons.
- **Fliesenzahl:** Anzahl der im Karton enthaltenen Fliesen.
- **Kaliber:** Gruppierung des Kartoninhalts nach Abmessung.
- **Farbton:** Farbnuance der gelieferten Fliesencharge.
- **EAN-Code:** Einzig für das jeweilige Produkt geltender Code in mit dem Barcode-Reader einlesbaren Strichen zur Identifizierung des Produkts.
- **Kontrolle:** Zahlencode zur Rückverfolgung des Produkts.



Check the delivery note | Comprueba el albarán | Vérifier le bon de livraison | Überprüfen Sie den Lieferschein



Check the product | Verifica el producto | Vérifier le produit | Überprüfen Sie das Produkt

2

PREPARE THE MATERIALS YOU NEED
PREPARA LOS MATERIALES QUE VAS A NECESITAR | PRÉPARER LES MATÉRIAUX NÉCESSAIRES | BEITEN SIE DIE BENÖTIGTEN MATERIALIEN VOR

To lay ceramic tiles correctly you will need a set of tools to facilitate the process, which are listed below:

- A. **Adhesive cement:** This should have an adherence capacity of C-2, which is suitable for laying porcelain tiles with a water absorption of less than 0.5% (BLA group, UNE-EN 14411 ISO13006)
- B. **Suction tile lifters.** These will help you to handle the tiles
- C. **Manual leveller, chalk reel and tape measure** for taking measurements
- D. **Levelling wedges**
- E. **Tile spacers**
- F. **Grouting material**
- G. **Palette**
- H. 10 mm **toothed trowel**
- I. **Bucket, mop and sponge**
- J. **Cleaning trowel**
- K. **Flexible rubber mallet;** not a rigid one
- L. **Adjustable pulling clamp**

En vue de pouvoir effectuer une correcte pose céramique, il convient de disposer d'une série d'instruments de soutien pour faciliter le travail, à savoir:

- A. **Ciment à prise rapide.** Il doit avoir un niveau d'adhérence de classe 2, approprié pour la pose de sols céramiques à absorption d'eau inférieure à 0,5% (Groupe Bla, UNE-EN 14411 ISO13006)
- B. **Ventouses.** Elles serviront pour la manipulation des pièces
- C. **Niveau manuel, cordeau à tracer et mètre ruban** pour effectuer des mesures.
- D. **Cales de nivellement**
- E. **Croisillons**
- F. **Pâte pour jointolement**
- G. **Palette**
- H. **Spatule dentée** de 10 millimètres
- I. **Seau et serpillière/seau de nettoyage et éponge**
- J. **Truelle de nettoyage**
- K. **Maillet en caoutchouc souple**
- L. **Pince de traction ajustable**

Para poder realizar una correcta colocación cerámica vas a necesitar una serie de instrumentos de apoyo que te facilitarán el trabajo y que te enumeramos a continuación:

- A. **Cemento de agarre.** Deberá tener capacidad de adherencia C-2, apropiada para instalar pavimento porcelánico de absorción de agua inferior a 0,5% (Grupo Bla, UNE-EN 14411 ISO13006)
- B. **Ventosas.** Te servirán para la manipulación de las piezas
- C. **Nivel manual, tiralíneas y flexómetro** para realizar mediciones.
- D. **Cuñas de nivelación**
- E. **Cruceñas**
- F. **Pasta para rejuntar**
- G. **Paleta**
- H. **Llana dentada** de 10 milímetros
- I. **Cubo y fregona / cubeta de limpieza y esponja**
- J. **Llana de limpieza**
- K. **Maza de goma flexible,** no rígida
- L. **Pinza de tracción ajustable**

Für ein korrektes Verlegen der Keramikfliesen brauchen Sie eine Reihe von Hilfsmitteln, die Ihnen die Arbeit erleichtern. Dabei handelt es sich um:

- A. **Klebemörtel.** Er muss ein Haftvermögen der Klasse C-2 aufweisen und für die Verlegung von Bodenbelägen aus Feinsteinzeug mit einer Wasseraufnahme von unter 0,5% geeignet sein (Gruppe Bla, UNE-EN 14411 ISO13006)
- B. **Saugnapfe.** Sie sind hilfreich beim Hantieren mit den Fliesen.
- C. **Wasserwaage, Richtschnur und Flexometer** für Messungen.
- D. **Nivellierkeile**
- E. **Kreuzlaschen**
- F. **Fugenmasse**
- G. **Kelle**
- H. 10 mm **Zahnschachtel**
- I. **Eimer und Wischmopp / Schüssel und Putzschwamm**
- J. **Fliesenwaschbrett**
- K. **Gummihammer** (biegsam, nicht starr)
- L. **Einstellbare Zange**



Prepare your materials | Prepara los materiales | Préparer les matériaux | Bereiten Sie die Materialien vor



3 WALLS FIRST PRIMERO EL REVESTIMIENTO | PREMIÈREMENT LE REVÊTEMENT | ZUERST DIE WANDFLIESEN

You should start with the walls in order to avoid any potential damage to the flooring. Make sure you leave enough space for laying the flooring afterwards.

Il convient de commencer par le revêtement pour éviter d'éventuels dommages postérieurs au pavement. À cette fin, il faut respecter l'espace suffisant afin de le poser plus tard.

Empezaremos por el revestimiento, para evitar posibles daños posteriores al pavimento. Para ello, respetaremos el espacio suficiente para poder instalarlo posteriormente.

Mit den Wandfliesen beginnen, um zu vermeiden, dass später die Bodenfliesen beschädigt werden. Darum den ausreichenden Raum für die anschließende Verlegung der Bodenfliesen lassen.

4 CHECK THE SURFACE LEVEL COMPRUEBA LA NIVELACIÓN | VÉRIFIER LE NIVELLEMENT | ÜBERPRÜFEN SIE DIE NIVELLIERUNG

The base of the floor slab or support upon which you are going to lay the tiles should be even so there are no gaps between the support and the back of the tile. However, during the curing process of the adhesive cement, small gaps or imperfections can appear between the tiles so we recommend you use levelling mortar, also known as self-levelling mortar.

This material lets you obtain a solid, smooth and uniform surface that is compatible with the adhesive applied before the installation of the tiles. There are different types of self-levelling mortar available, depending on where they are going to be used (interior or exterior). In addition, the thickness of the layer will depend on the intensity of transit and any difference in gradient to be offset (3-15 mm thick for light transit; 10-40 mm thick for commercial use; and 20-40 mm for intensive industrial transit).

La base du plancher ou support sur laquelle sera posé le dallage céramique doit être homogène de sorte à éviter des alvéoles entre le support et le dallage céramique. Mais durant le processus de prise du ciment colle, de petites différences de niveaux entre les pièces peuvent apparaître ; aussi il est recommandé d'utiliser du mortier de nivellement également connu comme mortier autonivelant.

Ce matériau permet d'obtenir un support solide et homogène, lisse et compatible avec les adhésifs préalables à la pose du dallage céramique. Il existe différents types de mortier autonivelant en fonction de l'utilisation (intérieur ou extérieur). En même temps, l'épaisseur de la couche dépendra du transit de personnes et de la différence de niveau à compenser (de 3 à 15 mm par couche pour un transit léger ; de 10 à 40 mm pour un usage commercial ; et de 20 à 40 mm pour un transit industriel intense).

La base de forjado o soporte sobre el que vas a instalar la baldosa cerámica debe ser homogénea para que no queden huecos entre el soporte y la baldosa cerámica. No obstante, durante el proceso de fraguado del cemento cola, pueden originarse pequeños desniveles o cejas entre las piezas por lo que te recomendamos que utilices mortero de nivelación, también conocido como autonivelante.

Este material te permitirá obtener un soporte sólido y homogéneo, liso y compatible con los adhesivos previos a la instalación del pavimento cerámico. Existen diferentes tipos de autonivelantes en función del uso (interior o exterior). Al mismo tiempo, el espesor de la capa dependerá del tránsito y del desnivel a compensar (de 3 a 15 mm por capa para tránsito ligero; de 10 a 40 mm para uso comercial; y de 20 a 40 mm para tránsito industrial intenso).

Das Bindwerk oder der Untergrund, auf dem die keramischen Fliesen verlegt werden sollen, muss gleichmäßig sein, damit sich zwischen Untergrund und keramischen Fliesen keine Hohlräume bilden. Allerdings können sich beim Erhärten des Zementklebers kleine Unebenheiten oder Überstände zwischen den Fliesen bilden. Deshalb empfehlen wir die Verwendung von Nivelliermörtel, auch Ausgleichsmasse genannt.

Mit diesem Material wird ein solider, glatter und gleichmäßiger Untergrund erzielt, der mit den vor der Verlegung der keramischen Bodenfliesen aufgetragenen Klebern kompatibel ist. Je nach Einsatz (drinnen oder draußen) sind verschiedene Arten von Ausgleichsmassen erhältlich. Ebenso hängt die Dicke der Schicht von der Beanspruchung und der ausgleichenden Unebenheit ab (3 bis 15 mm pro Schicht bei geringer Beanspruchung, 10 bis 40 mm bei gewerblicher Nutzung und 20 bis 40 mm für intensive industrielle Beanspruchung).



Check the level | Comprueba la nivelación | Vérifier le nivellement | Überprüfen Sie die Nivellierung



5 CHECK THAT THE SURFACE IS FREE FROM DUST COMPRUEBA QUE LA SUPERFICIE ESTÉ EXENTA DE POLVO | VÉRIFIER QUE LA SUPERFICIE SOIT EXEMPT DE POUSSIÈRE | ÜBERPRÜFEN SIE, DASS DIE OBERFLÄCHE STAUBFREI IST

You should also remove any other material such as leftover cement, lime scale, etc. The surface must be completely free from dust, grease and moisture.

Il convient d'éliminer les restes des autres matériaux tels que les résidus de mortier, la chaux, etc. La superficie doit aussi être exempte de poussière, de graisses et d'humidité.

Debes eliminar los restos de otros materiales, como residuos de cemento, cal, etc. Además, la superficie debe estar libre de polvo, grasas y humedad.

Reste anderer Materialien wie Zementrückstände, Kalk etc. müssen entfernt werden. Außerdem muss die Oberfläche frei von Staub, Fett und Feuchtigkeit sein.

6 SET A GUIDELINE PLANTEA LA LÍNEA MAESTRA | ÉTABLIR LA LIGNE MAGISTRALE | SPANNEN SIE DIE RICHTSCHRUR



Set the guideline | Plantea la línea maestra | Établir la ligne maestrale | Spannen Sie die Richtschnur.

The guideline should be parallel to the floor line. This will help you to lay the first tiles and means you will be able to make the most productive use of the tiles you have available.

La línea maestra debe ser paralela al pavimento. Te facilitará la instalación de las primeras baldosas y aprovecharás mayor cantidad de material cerámico.

La ligne principale doit être parallèle au dallage. Elle permet de faciliter l'installation des premiers carreaux et d'exploiter la plus grande quantité de matériel céramique.

Die Richtschnur muss parallel zu den Bodenfliesen verlaufen. Sie erleichtert die Verlegung der ersten Fliesen und ermöglicht eine bessere Ausnutzung des keramischen Materials.

7 HANDLE THE TILES CORRECTLY MANIPULA CORRECTAMENTE LAS PIEZAS | MANIPULER CORRECTEMENT LES PIÈCES | BEHANDELN SIE DIE FLIESEN KORREKT



Handle the tiles correctly | Manipula correctamente las piezas | Manipuler correctement les pièces | Behandeln Sie die Fliesen korrekt

Depending on the size of the tile, they may have to be handled by two people. To make this easier, you can use suction tile lifters to give you a better grip.

Dependiendo de su dimensión una pieza podría obligatoriamente tener que ser manipulada entre dos personas. Para facilitar el proceso, puedes ayudarte de ventosas con las que conseguirás una mayor adherencia y seguridad.

Selon ses dimensions, une pièce pourrait devoir obligatoirement être manipulée par deux personnes. Pour faciliter le processus, il est possible d'utiliser des ventouses pour obtenir une plus grande adhérence.

Je nach den Abmessungen kann es sein, dass zum Handtieren mit einer Fliese unbedingt zwei Personen notwendig sind. Zur Vereinfachung können Sie sich mit Saugnäpfen behelfen, mit denen Sie eine höhere Haftung erzielen.

8 CHOOSE THE LAYOUT OF THE TILES SELECCIONA LA DISPOSICIÓN DE LAS PIEZAS | SÉLECTIONNER LA DISPOSITION DES PIÈCES | WÄHLEN SIE DIE ANORDNUNG DER FLIESEN



Choose the layout of the tiles | Selecciona la disposición de las piezas | Sélectionner la disposition des pièces | Wählen Sie die Anordnung der Fliesen

All our tile collections have individual designs. We recommend that you lay them out flat before starting to install them to make sure that the different designs match up with their neighbouring tiles. The results can be amazing!

Nuestras colecciones tienen un diseño personalizado para cada una de las piezas. Te recomendamos que las plantees en la propia superficie, antes de su instalación, para asegurarte de situar diseños diferentes en piezas contiguas. El resultado será sorprendente.

Chaque pièce de nos collections a une conception personnalisée. Il est recommandé de les poser sur la propre surface, avant leur pose définitive, pour assurer de situer des dalles de diverses conceptions en pièces contiguës. Le résultat sera surprenant.

In unseren Kollektionen hat jede Fliese ein personalisiertes Muster. Wir empfehlen, die Fliesen vor dem Verlegen an die für die Verlegung vorgesehene Oberfläche halten, um sicherzustellen, dass unterschiedliche Muster an nebeneinanderliegenden Fliesen angebracht werden. Das Ergebnis ist erstaunlich.

9 CHOOSE THE ADHESIVE CEMENT ACCORDING TO THE INSTRUCTIONS SELECCIONA EL CEMENTO DE AGARRE SIGUIENDO LAS INDICACIONES | SÉLECTIONNER LE CIMENT À PRISE RAPIDE SELON LES INDICATIONS | WÄHLEN SIE DEN KLEBEMÖRTEL NACH DEN ANWEISUNGEN AUS

Adhesive cement is a technical adhesive specially prepared for affixing ceramic tiles. This type of mortar has a high polymer resin content, whose main advantages are excellent elasticity and adherence.

There are various different types of adhesive cement, depending on the type of ceramic tile you wish to lay (white paste, porcelain, etc.), the place you intend to lay them (interior or exterior), and even the weather conditions to which they will be exposed (damp areas, heat, frost, etc.). Both the adhesive and the grout form part of the whole cladding surface, and you should use the ones that are most appropriate for the type of ceramic product and its eventual use.

Le ciment colle est un adhésif technique préparé pour fixer la céramique. Ce type de mortier dispose d'une haute teneur en résines polymériques et a comme principaux avantages sa haute élasticité et sa grande adhérence.

Il existe sur le marché plusieurs variétés de ciment colle en fonction du type de céramique que l'on souhaite coller (pâte blanche, grès porcelainé, etc.), du lieu de l'installation (intérieur ou extérieur) ainsi que de la climatologie à laquelle sera exposé le produit (zones humides, chaleur, gel, etc.). L'adhésif et le jointoiement font partie du recouvrement et il convient d'appliquer ceux qui sont adéquats pour leur emploi et la typologie du produit céramique.

El cemento cola es un adhesivo técnico preparado para fijar cerámica. Este tipo de morteros cuentan con un alto contenido de resinas poliméricas y tienen como principales ventajas su elevada elasticidad y su gran adherencia.

Hay variedades distintas de cemento cola en función del tipo de cerámica que se desea pegar (pasta blanca, porcelánico, etc.), del lugar de instalación (interior o exterior), incluso de la climatología a la que se va a exponer el producto (zonas húmedas, calor, hielo, etc.). Tanto el adhesivo como el rejunte forman parte del recubrimiento y debemos aplicar aquellos que sean adecuados para su uso y tipología de producto cerámico.

Zementkleber ist ein technischer Klebstoff zum Befestigen von Keramik. Diese Art von Mörtel enthält einen hohen Anteil an Polymerharzen. Sein wesentlicher Vorteil ist seine hohe Elastizität und Haftung.

Je nach dem Keramiktyp, der geklebt werden soll (weißer Scherben, Feinsteinzeug etc.), dem Verlegungsort (drinnen oder draußen) und den Klimabedingungen, denen das Produkt ausgesetzt werden soll (feuchte Gebiete, Hitze, Frost etc.), gibt es unterschiedliche Arten von Zementkleber. Sowohl Kleber als auch Fugenmaterial sind Teil des Belags und müssen für die vorgesehene Verwendung und den Keramiktyp geeignet sein.



Prepare the adhesive cement | Prepara el cemento de agarre | Préparer le ciment à prise rapide
Bereiten Sie den Klebemörtel vor



Adhesive cement | Cemento de agarre | Ciment à prise rapide | Klebemörtel

HOW TO CHOOSE YOUR ADHESIVE | CÓMO ELEGIR ADHESIVO | COMMENT CHOISIR L'ADHÉSIF | DIE WAHL DES KLEBSTOFFS

According to Spanish and European law (standards EN 12002 and EN 12004 respectively), the type of adhesive for laying tiles must be coded according to common directives to make it easier to choose. This classification is based on the values of: adherence, curing time, slip resistance and open time.

Selon la réglementation espagnole et européenne (UNE-EN 12002 et UNE-EN 12004 respectivement), la typologie des adhésifs pour la pose des dalles doit être codifiée en fonction de directives communes pour faciliter le choix de l'utilisateur. Cette classification est basée sur des valeurs d'adhérence, prise, glissement et temps ouvert.

Según recoge la normativa española y europea (UNE-EN 12002 y UNE-EN 12004 respectivamente), la tipología de adhesivos para colocación de baldosas ha de codificarse en función de unas directrices comunes para que resulte más fácil su elección. Dicha clasificación se basa en valores de: adherencia, fraguado, deslizamiento y tiempo abierto.

Gemäß den Bestimmungen der spanischen und europäischen Vorschriften (UNE-EN 12002 bzw. UNE-EN 12004) müssen Klebstoffarten für die Fliesenverlegung nach gemeinsamen Richtlinien kodifiziert werden, um ihre Auswahl zu erleichtern. Diese Klassifizierung stützt sich auf folgende Werte: Haftung, Erhärtung, Abrutschverhalten und Offenzeit.

The classification of the adhesive uses a symbol (**C, D or R**), followed by an abbreviation of the class or classes to which it belongs. This classification is printed on all sacks of adhesive and their explanations are given below:

La designación del adhesivo se realiza con el símbolo (**C, D o R**), seguido de la abreviatura de la clase o clases a las que pertenece. Esta designación podrás observarla en cualquier saco de adhesivo, y aquí tienes todo su significado:

La désignation de l'adhésif est effectuée à l'aide du symbole (**C, D ou R**) suivi de l'abréviation de la classe ou des classes dont il relève. La signification de cette désignation qui peut être observée sur tout sac d'adhésif, est la suivante :

Die Bezeichnung erfolgt mit dem Symbol (**C, D oder R**), gefolgt von der Abkürzung der Klasse oder Klassen, denen der Kleber angehört. Diese Bezeichnung findet sich auf jedem beliebigen Sack Kleber. Hier die Erläuterung:

C: Cementitious adhesive | Adhesivo cementoso | Ciment colle | Zementärer Kleber
D: Dispersion adhesive | Adhesivo en dispersión | Adhésif en dispersion | Dispersionskleber
R: Reactive resin adhesive | Adhesivo de resinas reactivas | Adhésif à base de résines réactives
 Reaktionsharzkleber

Each of these different types may have a further classification according to its characteristics:

Para cada uno de estos tipos es posible que existan diferentes clases, en función sus características:

Pour chacun de ces types d'adhésifs, il peut exister diverses classes en fonction de leurs caractéristiques:

Für jeden dieser Typen kann es nach seinen Eigenschaften unterschiedliche Klassen geben:

1: Normal adhesive | Adhesivo normal | Adhésif normal | Normaler Kleber
2: Improved adhesive | Adhesivo mejorado | Adhésif amélioré | Verbesserter Kleber
F: Fast-setting adhesive | Adhesivo de fraguado rápido | Adhésif à prise rapide | Schnell erhärtender Kleber
T: Adhesive with reduced slip | Adhesivo con deslizamiento reducido | Adhésif avec glissement réduit | Kleber mit verringertem Abrutschverhalten
E: Adhesive with extended open time | Adhesivo con tiempo abierto ampliado | Adhésif avec temps ouvert élargi | Kleber mit verlängerter Offenzeit
S1: Deformable adhesive | Adhesivo deformable | Adhésif déformable | Verformbarer Kleber
S2: Highly deformable adhesive | Adhesivo altamente deformable | Adhésif hautement déformable | Stark verformbarer Kleber

To make it easier for you to choose, this information is summed up in the table below | Para que te resulte más fácil la elección, te resumimos toda la información en la siguiente tabla | Pour un choix plus facile des adhésifs, le tableau suivant résume toute l'information | Zur Erleichterung der Wahl werden alle Informationen in der folgenden Tabelle zusammengefasst:

TYPE TIPO TYP	CLASS CLASE CLASSE KLASSE	DESCRIPTION DESCRIPCIÓN DESCRIPTION BESCHREIBUNG	RECOMMENDED USE CUÁNDO DEBO UTILIZARLO QUAND L'UTILISER? EINSATZ
C	1	Cementitious adhesive with normal setting Adhesivo cementoso de fraguado normal Ciment colle à prise normale Normal erhärtender zementärer Kleber	Interior white porous wall tiles Revestimiento interior de porosa blanca Revêtement intérieur à surface poreuse blanche Wandfliesen aus weißem Scherben für Innenräume
C	1E	Cementitious adhesive with normal setting and extended open time Adhesivo cementoso de fraguado normal Ciment colle à prise normale avec temps ouvert élargi Normal erhärtender zementärer Kleber mit verlängerter Offenzeit	
C	1F	Fast setting cementitious adhesive Adhesivo cementoso de fraguado rápido Ciment colle à prise rapide Schnell erhärtender zementärer Kleber	
C	1FT	Fast setting cementitious adhesive with reduced slip Adhesivo cementoso de fraguado rápido con deslizamiento reducido Ciment colle à prise rapide avec glissement réduit Schnell erhärtender zementärer Kleber mit verringertem Abrutschverhalten	
C	2	Improved cementitious adhesive Adhesivo cementoso mejorado Ciment colle amélioré Verbesserter zementärer Kleber	Porcelain tiles for interior and exterior walls/floors Revestimiento y pavimento interior y exterior de porcelánico Revêtement et pavement intérieur et extérieur de grès porcelainé Wand- und Bodenfliesen aus Feinsteinzeug in Innen- und Außenräumen
C	2E	Cementitious adhesive with extended open time Adhesivo cementoso con tiempo abierto ampliado Ciment colle avec temps ouvert élargi Zementärer Kleber mit verlängerter Offenzeit	
C	2F	Fast setting improved cementitious adhesive Adhesivo cementoso mejorado de fraguado rápido Ciment colle amélioré à prise rapide Verbesserter schnell erhärtender zementärer Kleber	
C	2S1	Improved deformable cementitious adhesive Adhesivo cementoso mejorado deformable Ciment colle amélioré déformable Verformbarer verbesserter zementärer Kleber	
C	2S2	Improved highly deformable cementitious adhesive Adhesivo cementoso mejorado altamente deformable Ciment colle amélioré hautement déformable Stark verformbarer verbesserter zementärer Kleber	
C	2FT	Fast setting improved cementitious adhesive with reduced slip Adhesivo cementoso mejorado fraguado rápido con deslizamiento reducido Ciment colle amélioré prise rapide avec glissement réduit Schnell erhärtender verbesserter zementärer Kleber mit verringertem Abrutschverhalten	
C	2FTS1	Fast setting deformable improved cementitious adhesive with reduced slip Adhesivo cementoso mejorado fraguado rápido con deslizamiento reducido y deformable Ciment colle amélioré prise rapide avec glissement réduit et déformable Schnell erhärtender verbesserter zementärer und verformbarer Kleber mit verringertem Abrutschverhalten	

10 SPREADING THE ADHESIVE CEMENT ON THE LEVELLED SURFACE EXTIENDE EL CEMENTO DE AGARRE SOBRE LA SUPERFICIE YA NIVELADA | ÉTENDRE LE CIMENT À PRISE RAPIDE SUR LA SURFACE DÉJÀ NIVELÉE | VERSTREICHEN SIE DEN KLEBEMÖRTEL AUF DER BEREITS NIVELLIERTEN OBERFLÄCHE

Before spreading the adhesive cement, you need to prepare it. To do so, mix the product with water in the proportions indicated by the manufacturer, bearing in mind the length of time it will take to apply, before mixing it in a builders' bucket until you have the appropriate texture to affix the tile correctly.

Following the established guideline, spread the adhesive cement on the compacted and levelled surface with the help of a toothed trowel.

Avant de l'étendre, le ciment à prise rapide doit être préparé. À cette fin, mélanger le produit et l'eau selon les proportions indiquées par le fabricant, en tenant compte du temps d'application pour, postérieurement, le gâcher dans un bac jusqu'à obtenir la texture adéquate pour pouvoir poser correctement la dalle. Suivant la ligne maestrale établie, étendre le ciment colle sur la surface déjà compactée et nivelée à l'aide de la spatule dentée.

Antes de extenderlo, debemos prepararlo. Para ello mezclaremos en la proporción indicada por el fabricante el producto y el agua, teniendo en cuenta el tiempo de aplicación, para, posteriormente, batirlo en un capazo hasta que obtengamos la textura adecuada para poder instalarla baldosa de forma correcta.

Siguiendo la línea maestra establecida, extenderemos con ayuda de la llana dentada, el cemento de agarre sobre la superficie ya compactada y nivelada.

Vor dem Verstreichen muss er angerührt werden. Dazu das Produkt unter Berücksichtigung der Auftragszeit in dem vom Hersteller des Produkts angegebenen Verhältnis mit Wasser mischen und anschließend in einem Eimer kräftig verrühren, bis die zum Verlegen der Fliesen geeignete Textur erzielt ist.

Den Klebemörtel mit einem Zahnpachtel an der gespannten Richtschnur entlang auf der bereits ausgehärteten und nivellierten Oberfläche verstreichen.



Spread the adhesive cement with a toothed trowel | Extiende el cemento de agarre con una llana dentada | Étendre le ciment à prise rapide à l'aide d'une spatule dentée | Verstreichen Sie den Klebemörtel mit einem Zahnpachtel



Make sure the thickness of the layer of adhesive cement is uniform | Asegúrate de que el grosor de la capa de cola sea uniforme | Veiller à ce que l'épaisseur de la couche de ciment colle soit uniforme | Vergewissern Sie sich, dass die Kleberschicht gleichmäßig ist

11 SPREAD THE ADHESIVE CEMENT ON THE BACK OF THE TILE REPARTE EL CEMENTO SOBRE LA PIEZA CERÁMICA | RÉPARTIR LE CIMENT SUR LA PIÈCE EN CÉRAMIQUE | VERTEILEN SIE DEN KLEBEMÖRTEL AUF DER KERAMIKFLIESE

You should also spread the adhesive cement on the rib of the ceramic tile so that it creates a double adhesive surface between the surface support and the back of the tile.

Make sure that the layer of adhesive cement is always the same thickness. To do so, you can use a 10 mm toothed trowel to spread the adhesive perpendicularly to the long side of the tile so that any air that might be trapped underneath can escape.

Étendre également le ciment à prise rapide sur le côté de la pièce de céramique, de sorte à générer un double encollage sur le support du plancher et sur le côté de la pièce. Veiller à ce que la couche de ciment colle ait toujours la même épaisseur. À cette fin, utiliser une spatule dentée de 10 mm, et répartir l'adhésif perpendiculairement au côté le plus long pour que l'air éventuel susceptible de rester dessus puisse s'échapper.

Extenderemos también cemento de agarre sobre la costilla de la pieza cerámica, de manera que se genere un doble encolado, tanto en el soporte del forjado como en la costilla la pieza.

Asegúrate de que la capa de cemento cola tenga siempre el mismo grosor. Para conseguirlo nos ayudaremos de una llana dentada con un tamaño de diente de 10 mm, y distribuiremos el adhesivo en dirección perpendicular al lado largo de la pieza para que el posible aire que pueda quedar debajo pueda escapar.

Der Klebemörtel wird auch auf die Unterseite der Keramikfliese aufgetragen. Dadurch erfolgt ein doppeltes Verkleben, sowohl auf dem Untergrund als auch auf der Fliesenunterseite.

Vergewissern Sie sich, dass die Zementkleberschicht stets gleichmäßig dick ist. Um dies zu gewährleisten, behelfen wir uns mit einem Zahnpachtel mit einer Zahngröße von 10 mm und verteilen den Kleber lotrecht zur Längsseite der Fliese, damit die eventuell darunter verbleibende Luft entweichen kann.



Spread the adhesive cement with a toothed trowel on the tile | Extiende el cemento de agarre con una llana dentada sobre la pieza | Étendre le ciment à prise rapide à l'aide d'une spatule dentée sur la pièce | Verstreichen Sie den Klebemörtel mit einem Zahnpachtel auf der Fliese



Make sure the thickness of the layer of adhesive cement is uniform | Asegúrate de que el grosor de la capa de cola sea uniforme | Veiller à ce que l'épaisseur de la couche de colle soit uniforme | Vergewissern Sie sich, dass die Kleberschicht gleichmäßig ist

12 LAYING THE TILE INSTALA LA PIEZA | POSE DE LA PIÈCE | VERLEGEN SIE DIE FLIESE

Once you have spread the adhesive cement on the back of the tile, affix it to the support surface, which will already have been treated with adhesive cement, following the guidelines you established earlier. Affix the tile by tapping it gently with the flexible rubber mallet to get rid of any possible air bubbles in the adhesive cement.

Once you have spread the mortar you can start laying the tiles, bearing in mind that you need to keep a minimum joint of at least 2 mm. The same distance between each tile can be replicated with the help of tile spacers.

Après collage du dos de la pièce avec le ciment à prise rapide, l'accoupler à la surface déjà préalablement tracée, suivant la ligne maestrale tracée. Poser la pièce en frappant légèrement à l'aide du maillet en caoutchouc souple pour éliminer d'éventuelles bulles d'air produites dans le ciment colle.

Une fois le mortier étendu, placer les pièces en veillant à laisser entre elles un jointolement minimal d'au moins 2 mm. Cette distance entre les pièces peut être maintenue à l'aide des croisillons de séparation.



Affix the tile to the pre-prepared surface | Coloca la pieza sobre la superficie preparada | Placer la pièce sur la surface préparée | Verlegen Sie die Fliese auf der vorbereiteten Oberfläche

Una vez encolada la parte trasera de la pieza con el cemento de agarre, procederemos a acoplarla en la superficie ya trazada previamente con cemento de agarre, siguiendo la línea maestra trazada. Asentaremos la pieza golpeando suavemente con la maza de goma flexible para eliminar posibles burbujas de aire producidas en el cemento cola.

Una vez se haya colocado el mortero, se pueden empezar a colocar las piezas teniendo en cuenta que entre ellas debe guardarse una junta mínima de al menos 2 mm. Esta distancia entre piezas se puede mantener con la ayuda de cruceñas de separación.

Die Fliese nach dem Auftragen des Klebers auf die Rückseite der Fliese an die zuvor mit Klebemörtel behandelte Oberfläche drücken und sich dabei an der gespannten Richtschnur orientieren. Die Fliese mit dem biegsamen Gummihammer vorsichtig festklopfen, um eventuelle Luftblasen im Zementkleber zu beseitigen.

Nach dem Auftragen des Mörtels kann damit begonnen werden, die Fliesen zu verlegen. Dabei berücksichtigen, dass zwischen den Fliesen eine Fuge von mindestens 2 mm vorgesehen werden muss. Dieser Abstand zwischen den Fliesen kann mit Hilfe von Kreuzlaschen sichergestellt werden.



Use the flexible rubber mallet | Utiliza una maza de goma flexible | Utiliser un maillet en caoutchouc souple | Verwenden Sie einen biegsamen Gummihammer

13 LEVELLING SYSTEM SISTEMA DE NIVELACIÓN | SYSTÈME NIVELANT | NIVELLIERSYSTEM

For rectified floors and walls, we recommend the RLS Levelling System by Raimondi or a similar system. This method works as follows:

Pour les pavements et les revêtements rectifiés, il est recommandé d'employer le R.S.L.-système nivelant Raimondi ou similaire. Le mode d'emploi est le suivant:

Para pavimentos y revestimientos rectificadas se recomienda el Sistema de Nivelación RLS de la empresa Raimondi o similar. El modo de uso es el siguiente:

Für Wand- und Bodenfliesen mit Kantenschnitt wird das RLS Nivelliersystem der Firma Raimondi oder ein gleichwertiges System empfohlen. Gebrauchsanleitung:

13A SETTING THE BASE/CLIP COLOCACIÓN DEL SOPORTE | POSE DU SUPPORT | ANBRINGEN DER LASCHEN



1. After spreading the adhesive cement, insert the clips underneath the tiles on all four sides.

1. Después de extender el cemento cola, colocar los soportes debajo de las piezas en los 4 lados.

1. Après avoir étendu le ciment colle, placer les supports sous les 4 côtés des pièces.

1. Nach Verstreichen des Zementklebers Laschen an den 4

Seiten unter den Fliesen anbringen.

2. For large tiles, use more clips on each side.

2. Para piezas de gran tamaño usar más soportes por lado.

2. Pour les pièces de grandes dimensions, utiliser davantage de supports par côté.

2. Bei großen Formaten mehrere Laschen pro Seite verwenden.

3. Lay the tile and tap with the rubber mallet.

3. Colocar la baldosa y golpear con el mazo de goma.

3. Poser la dalle et frapper à l'aide du maillet en caoutchouc souple.

3. Fliese verlegen und mit dem Gummihammer festklopfen.

13B INSERTING THE WEDGES INSERCIÓN DE LAS CUÑAS | INSERTION DES CALES | ANBRINGUNG DER KEILE

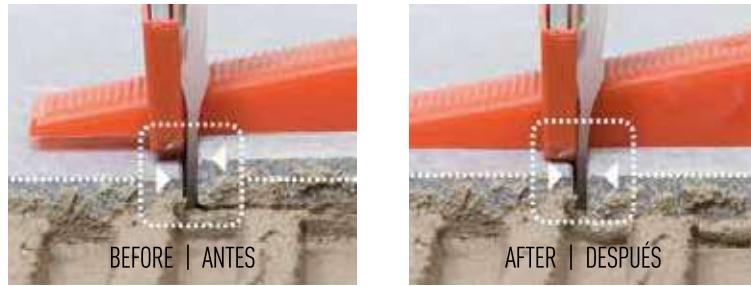

1. Insert the wedges in the clip slot, making sure you don't pass the breakpoint.
1. Insertar las cuñas en el alojamiento apretando sin superar el punto de rotura.
1. Insérer les cales dans le logement en serrant le point de rupture.
1. Keile in die Aufnahme einführen und andrücken, ohne die Bruchstelle zu überschreiten.



2. We recommend the use of adjustable traction pliers to make this task easier.
2. Para facilitar esta tarea se aconseja el uso de la pinza de tracción ajustable.
2. Pour faciliter cette tâche, il est recommandé d'utiliser la pince de traction ajustable.
2. Zur Erleichterung dieses Arbeitsschrittes empfiehlt sich der Einsatz der einstellbaren Zange.

13C REMOVING THE SUPPORT ELIMINACIÓN DEL SOPORTE | ÉLIMINATION DU SUPPORT | ENTFERNUNG DER LASCHEN



Once the adhesive cement has set, to remove the clip you simply need to tap it with the rubber mallet or the tip of your toe in the direction of the joint.

Une fois le ciment colle pris, pour retirer le support, il suffit de frapper à l'aide du maillet en caoutchouc souple ou avec la pointe du pied dans la direction du jointoiment.



Una vez fraguado el cemento cola, para arrancar el soporte basta con golpear con el mazo de goma o con la punta del pie en la dirección de la junta.

Nach Aushärten des Zementklebers lassen sich die Laschen problemlos entfernen, indem man mit dem Gummihammer oder der Fußspitze in Fugenrichtung drückt.



Example of using the RLS Levelling System to lay tiles on walls and floors.

Exemple de pose R.S.L.-Système nivelant Raimonci dans les revêtements et pavements.



Ejemplo de colocación del Sistema de Nivelación Rls en Revestimiento (fig.10) y Pavimento (fig.11)

Verlegungsbeispiel des RLS Nivelliersystems bei Wandfliesen und bei Bodenfliesen.

14 ADHERE TO THE MINIMUM JOINT WIDTH RESPETA LAS JUNTAS MÍNIMAS | RESPECTER LES JOINTOIEMENTS MINIMUMS | HALTEN SIE DIE MINDESTFUGEN EIN

The tables given below give the general recommendations for sizing the width of the joint depending on whether it is for:

- Laying joints: these offset dimensional variations and are found between the tiles.
- Perimeter joints: these reduce the build-up of structural pressure between elements that restrict movement.
- Partition joints: these prevent the impact of contractions and dilations.
- Structural joints: these are intended to absorb structural movements.

Les tableaux ci-après exposent les recommandations générales pour le calcul de la largeur du jointoiment en fonction de :

- La pose ; compense les écarts dimensionnels et se trouve entre les dalles.
- Du périmètre, réduit la tension dans la rencontre entre éléments qui limitent le mouvement.
- La partition, évite l'accumulation de dilatations et de contractions.
- La structure, absorbe les mouvements structurels.

En las tablas que se presentan a continuación se definen las recomendaciones generales para el dimensionamiento del ancho de junta en función ésta sea de:

- Colocación; compensa desviaciones dimensionales y se encuentra entre baldosas.
- Perimetral, reduce la tensión en el encuentro entre elementos que limitan el movimiento.
- De partición, evita que se acumulen dilataciones y contracciones.
- Estructural, absorbe los movimientos estructurales.

In den untenstehenden Tabellen finden sich die allgemeinen Empfehlungen für die Dimensionierung der Fugenbreite je nach Funktion der Fuge:

- Verlegungsfuge: Befindet sich zwischen Fliesen und gleicht Abweichungen der Abmessungen aus.
- Umlaufende Fuge: Mindert die Spannung beim Aufeinandertreffen von Elementen, die die Bewegung einschränken.
- Trennfuge: Verhindert die Anhäufung von Ausdehnungen und Kontraktionen.
- Strukturfuge: Absorbiert Strukturbewegungen.

TYPE OF JOINT TIPO DE JUNTA TYPE DE JOINTOIEMENT FUGENTYP	INTERIOR INTÉRIEUR INNENRÄUME				
	Floors Pavimento Pavement Bodenfliesen		Walls Revestimiento Revêtement Wandfliesen		
	When should I use it? ¿Cuándo debo plantearla? Quand doit-il être posé? Wann muss ich sie anbringen?	How wide should it be? ¿Cuánto debe medir? Combien doit-il mesurer? Wie breit muss sie sein?		When should I use it? ¿Cuándo debo plantearla? Quand doit-il être posé? Wann muss ich sie anbringen?	How wide should it be? ¿Cuánto debe medir? Combien doit-il mesurer? Wie breit muss sie sein?
LAYING JOINT JUNTA DE COLOCACIÓN JOINTOIEMENT DE POSE VERLEGUNGSFUGE	Across the whole area En toda la superficie Sur toute la surface Auf der ganzen Oberfläche	Rectified Rectificado Rectifié Mit Kantenschnitt > 2 mm No rectified No rectificado Non rectifié Ohne Kantenschnitt > 2,5 mm		Across the whole area En toda la superficie Sur toute la surface Auf der ganzen Oberfläche	Rectified Rectificado Rectifié Mit Kantenschnitt > 1,5 mm Non-rectified No rectificado Non rectifié Ohne Kantenschnitt > 2,5 mm
PERIMETER JOINT JUNTA PERIMETRAL JOINTOIEMENT PÉRIMETRAL UMLAUFENDE FUGE	At the edge of the section in rooms larger than 7 m ² En el perímetro del paño en estancias mayores a 7m ² Sur le périmètre du côté des pièces supérieures à 7m ² An der äußeren Begrenzung des Fliesenverbunds in Räumen über 7 m ²	> 5 mm		At the edge of the section in rooms larger than 7 m ² En el perímetro del paño en estancias mayores a 7m ² Sur le périmètre du côté des pièces supérieures à 7m ² An der äußeren Begrenzung des Fliesenverbunds in Räumen über 7 m ²	> 5 mm
PARTITION JOINT JUNTA DE PARTICIÓN JOINTOIEMENT DE PARTITION TRENNFUGE	In areas of 40 - 80 m ² En superficies de 40 a 80 m ² Sur des surfaces de 40 à 80 m ² Auf Oberflächen von 40 bis 80 m ²	> 5 mm		In areas of 40 - 80 m ² En superficies de 40 a 80 m ² Sur des surfaces de 40 à 80 m ² Bei Oberflächen von 40 bis 80 m ²	> 5 mm
STRUCTURAL JOINT JUNTA ESTRUCTURAL JOINTOIEMENT STRUCTUREL STRUKTURFUGE	Always, as a continuation of the building's structural joint. Siempre. Continuando con la junta estructural del edificio. Toujours. Continuant avec le jointoiment structurel du bâtiment. Immer. Als Fortführung der Strukturfuge des Gebäudes	The same as the structural joint of the support. La de la junta estructural del soporte. Celui du jointoiment structurel du support. So breit wie die Strukturfuge des Untergrunds.		Always, as a continuation of the building's structural joint. Siempre. Continuando con la junta estructural del edificio. Toujours. Continuant avec le jointoiment structurel du bâtiment. Immer. Als Fortführung der Strukturfuge des Gebäudes	The same as the structural joint of the support. La de la junta estructural del soporte. Celui du jointoiment structurel du support. So breit wie die Strukturfuge des Untergrunds.

EXTERIOR | EXTÉRIEUR | AUSSEN RÄUME

TYPE OF JOINT TIPO DE JUNTA TYPE DE JOINTOIEMENT FUGENTYP	Floors Pavimento Pavement Bodenfliesen		Façades Fachadas Façades Fassaden		
	When should I use it? ¿Cuándo debo plantearla? Quand doit-il être posé? Wann muss ich sie anbringen?	How wide should it be? ¿Cuánto debe medir? Combien doit-il mesurer? Wie breit muss sie sein?	When should I use it? ¿Cuándo debo plantearla? Combien doit-il mesurer? Wann muss ich sie anbringen?	How wide should it be? ¿Cuánto debe medir? Combien doit-il mesurer? Wie breit muss sie sein?	
LAYING JOINT JUNTA DE COLOCACIÓN JOINTOIEMENT DE POSE VERLEGUNGSFUGE	Across the whole area En toda la superficie Sur toute la surface Auf der ganzen Oberfläche	Rectified Rectificado Rectifié Mit Kantenschnitt	> 2 mm	Across the whole area En toda la superficie Sur toute la surface Auf der ganzen Oberfläche	> 2,5 mm
		Non-rectified No rectificado Non rectifié Ohne Kantenschnitt	> 2,5 mm		
PERIMETER JOINT JUNTA PERIMETRAL JOINTOIEMENT PÉRIMETRAL UMLAUFENDE FUGE	At the edge of the section in rooms larger than 7 m ² En el perímetro del paño en estancias mayores a 7m ² Sur le périmètre du côté des pièces supérieures 7m ² An der äußeren Begrenzung des Fliesenverbunds in Räumen über 7 m ²	> 5 mm	At the edge of the section and in interior corners, and in general at unique points where it is necessary for the ceramic cladding to move. En el perímetro del paño y esquinas interiores, y en general en aquellos puntos singulares en los que sea necesario el movimiento del revestimiento cerámico. Sur le périmètre du côté et des coins intérieurs, et en général sur les points singuliers où le mouvement du revêtement céramique est nécessaire. An der äußeren Begrenzung des Fliesenverbunds und innenliegenden Ecken sowie allgemein an jenen Stellen, an denen die Bewegung der keramischen Wandfliesen notwendig ist.	> 5 mm	
PARTITION JOINT JUNTA DE PARTICIÓN JOINTOIEMENT DE PARTITION TRENNFUGE	In areas of 20 - 40 m ² or every 8-10 linear metres En superficies de 20 a 40 m ² o cada 8 a 10 m lineales Sur des surfaces de 20 à 40 m ² ou tous les 8 à 10 m linéaires Auf Oberflächen von 20 bis 40 m ² oder alle 8 bis 10 laufende Meter	> 5 mm	In areas of 9 - 12 m ² or every 8-10 linear metres, being particularly restrictive if the ceramic tiles are dark. De 9 a 12 m ² o cada 8 a 10 m, lineales especialmente restrictivo en caso de que el producto cerámico sea de color oscuro De 9 à 12 m ² ou tous les 8 à 10 m linéaires particulièrement restrictif si la couleur du produit en céramique est sombre Von 9 bis 12 m ² oder alle 8 bis 10 laufende Meter, vor allem bei keramischen Produkten in einer dunklen Farbe	8 y 10 mm	
STRUCTURAL JOINT JUNTA ESTRUCTURAL JOINTOIEMENT STRUCTUREL STRUKTURFUGE	Always, as a continuation of the building's structural joint. Siempre. Continuando con la junta estructural del edificio. Toujours. Continuant avec le jointoiment structurel du bâtiment. Immer. Als Fortführung der Strukturfuge des Gebäudes	The same as the structural joint of the support. It must include a polyurethane strand or a compensation profile. La de la junta estructural del soporte. Debe incluir cordón de poliuretano o perfil de compensación. Celui du jointoiment structurel du support. Il doit comprendre un cordon de polyuréthane ou un profil de compensation. So breit wie die Strukturfuge des Untergrunds. Muss Polyurethan-Schnur oder Ausgleichprofil enthalten.	Always, as a continuation of the building's structural joint. Siempre. Continuando con la junta estructural del edificio. Toujours. Continuant avec le jointoiment structurel du bâtiment. Immer. Als Fortführung der Strukturfuge des Gebäudes	The same as the structural joint of the support. It must include a polyurethane strand or a compensation profile of 6 - 35 mm. La de la junta estructural del soporte. Debe incluir cordón de poliuretano o perfil de compensación de 6 a 35 mm. Celui du jointoiment structurel du support. Il doit comprendre un cordon de polyuréthane ou un profil de compensation de 6 à 35 mm. So breit wie die Strukturfuge des Untergrunds. Muss Polyurethan-Schnur oder Ausgleichprofil von 6 bis 35 mm enthalten.	

15 SELECT THE GROUTING MATERIAL
SELECCIONA EL MATERIAL DE REJUNTE | SÉLECTIONNER LE MATÉRIAU DE JOINTOIEMENT | WÄHLEN SIE DAS FUGENMATERIAL

The table below gives recommendations based on the EN 13888 standard for the grouting material to be used depending on the type of joint, and the specific commercial reference for each case according to whether the laying surfaces are interior or exterior and whether the material is for floor or wall tiles.

Le tableau ci-après présente une recommandation basée sur la norme UNE EN 13888 sur le matériau de jointoiment à utiliser en fonction du type de jointoiment, ainsi qu'une référence commerciale spécifique pour chaque cas selon que les surfaces de pose sont intérieures ou extérieures et que le matériau à poser est pour un pavement ou pour un revêtement.

A continuación se presenta una recomendación basada en la norma UNE EN 13888 acerca del material de rejunte a utilizar en función del tipo de junta, así como una referencia comercial específica para cada caso en función de si las superficies de colocación son interiores o exteriores y el material a colocar sea pavimento o revestimiento.

Im Anschluss folgt die Darstellung einer Empfehlung auf Grundlage der Norm UNE EN 13888 über das je nach Fugentyp zu verwendende Fugenmaterial sowie eine spezifische Produktempfehlung für jeden Fall, je nachdem, ob sich die Verlegungsflächen in Innen- oder Außenräumen befinden und ob es sich um Wand- oder Bodenfliesen handelt.

INTERIOR | INTÉRIEUR | INNEN RÄUME

TYPE OF JOINT TIPO DE JUNTA TYPE DE JOINTOIEMENT FUGENTYP	AS PER THE UNE EN 13888 STANDARD SEGÚN NORMATIVA UNE EN 13888 SELON NORME UNE EN 13888 GEMÄSS NORM UNE EN 13888		RECOMMENDED COMMERCIAL PRODUCT REFERENCIA COMERCIAL RECOMENDADA RÉFÉRENCE COMMERCIALE RECOMMANDÉE EMPFOHLENES PRODUKT	
	Floors Pavimento Pavement Bodenfliesen	Walls Revestimiento Revêtement Wandfliesen	Floors Pavimento Pavement Bodenfliesen	Walls Revestimiento Revêtement Wandfliesen
LAYING JOINT JUNTA DE COLOCACIÓN JOINTOIEMENT DE POSE VERLEGUNGSFUGE	TYPE CG2 Improve cementitious grout Rejuntado cementoso mejorado Jointoiment de mortier amélioré Verbesserter zementärer Fugenmörtel	TYPE CG1, TYPE CG2 RG shower zones RG zonas de ducha RG zones de douche RG Duschbereiche	Fugabella ECO Porcelana 0-5 (CG2'WA) (0 a 5 mm)	Fugabella ECO Porcelana 0-5 (CG2'WA) (0 - 5 mm)
PERIMETER JOINT JUNTA PERIMETRAL JOINTOIEMENT PÉRIMETRAL UMLAUFENDE FUGE	MINIMUM TYPE CG2 Improved cementitious grout Rejuntado cementoso mejorado Jointoiment de mortier amélioré Verbesserter zementärer Fugenmörtel	MINIMUM TYPE CG2 Improved cementitious grout Rejuntado cementoso mejorado Jointoiment de mortier amélioré Verbesserter zementärer Fugenmörtel	Fugabella ECO PU (8 a 35 mm)	Fugabella ECO PU 40 (6 a 35 mm)
PARTITION JOINT JUNTA DE PARTICIÓN JOINTOIEMENT DE PARTITION TRENNFUGE	MINIMUM TYPE CG2 Improved cementitious grout Rejuntado cementoso mejorado Jointoiment de mortier amélioré Verbesserter zementärer Fugenmörtel	MINIMUM TYPE CG2 Improved cementitious grout Rejuntado cementoso mejorado Jointoiment de mortier amélioré Verbesserter zementärer Fugenmörtel	Fugabella ECO PU (8 a 35 mm)	Fugabella ECO PU (8 a 35 mm)
STRUCTURAL JOINT JUNTA ESTRUCTURAL JOINTOIEMENT STRUCTUREL STRUKTURFUGE	MINIMUM TYPE CG2 Improved cementitious grout Rejuntado cementoso mejorado Jointoiment de mortier amélioré Verbesserter zementärer Fugenmörtel	MINIMUM TYPE CG2 Improved cementitious grout Rejuntado cementoso mejorado Jointoiment de mortier amélioré Verbesserter zementärer Fugenmörtel	Fugabella ECO PU 40 (6 a 35 mm)	Fugabella ECO PU 40 (6 a 35 mm)

EXTERIOR EXTÉRIEUR AUSSEN RÄUME				
AS PER THE UNE EN 13888 STANDARD SEGÚN NORMATIVA UNE EN 13888 SELON NORME UNE EN 13888 GEMÄSS NORM UNE EN 13888		RECOMMENDED COMMERCIAL PRODUCT REFERENCIA COMERCIAL RECOMENDADA RÉFÉRENCE COMMERCIALE RECOMMANDÉE EMPFOHLENES PRODUKT		
TYPE OF JOINT TIPO DE JUNTA TYPE DE JOINTOIEMENT FUGENTYP	Floors Pavimento Pavement Bodenfliesen	Façades Fachadas Façades Fassaden	Floors Pavimento Pavement Bodenfliesen	Façades Fachadas Façades Fassaden
LAYING JOINT JUNTA DE COLOCACIÓN JOINTOIEMENT DE POSE VERLEGUNGSFUGE	TYPE CG2 RG for the food industry, healthcare buildings and chemical aggression RG para usos alimentarios, sanitarios y de agresividad química RG pour usages alimentaires, sanitaires et à agressivité chimique RG pour usages alimentaires, sanitaires et à agressivité chimique RG Lebensmittel- und Hygieneumgebung sowie chemische Aggressivität	TYPE CG2	Fugabella ECO Porcelana 0-5 (CG2'WA) (0 a 5 mm)	Fugabella ECO 2-12 (CG2'WA) (2 a 12 mm)
PERIMETER JOINT JUNTA PERIMETRAL JOINTOIEMENT PÉRIMETRAL UMLAUFENDE FUGE	MINIMUM TYPE CG2 RG for the food industry, healthcare buildings and chemical aggression RG para usos alimentarios, sanitarios y de agresividad química RG pour usages alimentaires, sanitaires et à agressivité chimique RG Lebensmittel- und Hygieneumgebung sowie chemische Aggressivität RG Lebensmittel- und Hygieneumgebung sowie chemische Aggressivität	MINIMUM TYPE CG2	Fugabella ECO PU 40 (6 a 35 mm)	Fugabella ECO PU (8 a 35 mm)
PARTITION JOINT JUNTA DE PARTICIÓN JOINTOIEMENT DE PARTITION TRENNFUGE	MINIMUM TYPE CG2 RG for the food industry, healthcare buildings and chemical aggression MINIMO TIPO CG2 RG para usos alimentarios, sanitarios y de agresividad química MINIMUM TYPE CG2 RG pour usages alimentaires, sanitaires et à agressivité chimique MINDESTENS TYP CG2 RG Lebensmittel- und Hygieneumgebung sowie chemische Aggressivität	MINIMUM TYPE CG2	Fugabella ECO PU (8 a 35 mm)	Fugabella ECO PU (8 a 35 mm)
STRUCTURAL JOINT JUNTA ESTRUCTURAL JOINTOIEMENT STRUCTUREL STRUKTURFUGE	MINIMUM TYPE CG2 RG for the food industry, healthcare buildings and chemical aggression RG para usos alimentarios, sanitarios y de agresividad química RG pour usages alimentaires, sanitaires et à agressivité chimique RG Lebensmittel- und Hygieneumgebung sowie chemische Aggressivität	MINIMUM TYPE CG2	Fugabella ECO PU 40 (6 a 35 mm)	Fugabella ECO PU 40 (6 a 35 mm)

TYPES OF GROUTING MATERIAL | TIPOS DE MATERIAL DE REJUNTADO | TYPES DE MATÉRIAU DE JOINTOIEMENT | FUGENMATERIALTYPEN

- CG1** Standard cementitious grout | Rejuntado cementoso normal | Jointoiment de ciment normal | Normaler zementärer Fugenmörtel
- CG2** Improved cementitious grout | Rejuntado cementoso mejorado | Jointoiment de ciment amélioré | Verbesserter zementärer Fugenmörtel
- RG** Reactive resins (usually epoxy) Resinas sintéticas (generalmente epoxi) | Résines synthétiques (généralement époxy) | Synthetische Harze (im Allgemeinen Epoxy)

L

Portland cement grout, only recommended in less demanding situations such as interior spaces with no additional requirements. It is not recommended for hygienic areas or those that are cleaned frequently, nor in bathrooms due to its high porosity.
Lechada de cemento portland, solo recomendada en supuestos poco exigentes tales como espacios en interiores sin ninguna solicitud adicional. No se recomienda en zonas higiénicas o de limpieza frecuente, ni en baños dada su alta porosidad
Lait de ciment Portland, uniquement recommandé pour des cas peu exigeants comme des espaces en intérieur sans aucune demande supplémentaire. Non recommandé pour les zones aseptiques ou à nettoyage fréquent, ni dans les salles de bain en raison de sa haute porosité.
Mörtelbett aus Portlandzement. Nur für wenig beanspruchte Flächen wie Innenräume ohne zusätzliche Anforderungen empfohlen. Wegen der hohen Porosität nicht empfohlen in Hygienebereichen oder häufig gereinigten Bereichen sowie Badezimmern.

16 PREPARING AND APPLYING THE GROUT PREPARA Y APLICA EL MATERIAL DE REJUNTE | PRÉPARER ET APPLIQUER LE MATÉRIAU DE JOINTOIEMENT | RÜHREN SIE DAS FUGENMATERIAL AN UND TRAGEN SIE ES AUF

The preparation of the grout follows a similar process to that of the adhesive cement. Consequently, you mix the product with water in the proportions indicated by the manufacturer before spreading the grout in the gap between the tiles and affixing it with the help of a grouting trowel. You need to bear in mind the timings recommended by the manufacturer.

La préparation de la pâte de jointoiment suit un processus similaire à celui du ciment colle. Ainsi, mélanger le produit et l'eau selon les proportions indiquées par le fabricant pour ensuite étendre le matériau de jointoiment entre la séparation qu'il y a entre les pièces et la fixer à l'aide d'une spatule pour joints. Il est nécessaire de prendre en compte les temps recommandés par le fabricant.



Prepare the grout | Prepara el material de rejuntado | Préparer le matériau de jointoiment | Rühren Sie das Fugenmaterial an

La preparación de la pasta de rejuntado sigue un proceso similar al del cemento cola. De este modo, mezclaremos en la proporción indicada por el fabricante, el producto y agua para posteriormente extender el material de rejuntado entre la separación que hay entre las piezas y fijarlo con la ayuda de una llana de rejuntado. Es necesario tener en cuenta los tiempos recomendables por el fabricante.

Die Fugenmasse wird ähnlich wie der Zementkleber zubereitet. Produkt und Wasser in dem vom Hersteller angegebenen Verhältnis mischen. Anschließend das Fugenmaterial in die Zwischenräume zwischen den Fliesen füllen und mit einer Fugenkelle andrücken. Die vom Hersteller empfohlenen Zeiten müssen berücksichtigt werden.



Use a grout trowel to affix the material | Utiliza una llana de rejuntado para fijar el material | Utiliser une spatule pour joints pour fixer le matériau | Verwenden Sie eine Fugenkelle zum Andrücken des Materials

17 REMOVING EXCESS GROUT AND CLEANING THE SURFACE RETIRA EL MATERIAL SOBRENTE Y LIMPIA LA SUPERFICIE | RETIRER LE MATÉRIAU EN EXCÈS ET NETTOYER LA SURFACE | ENTFERNEN SIE MATERIALRESTE UND REINIGEN SIE DIE OBERFLÄCHE

After spreading the grout it is essential to clean the area thoroughly to remove any residue and general dirt from the working area, avoiding the use of abrasive products such as hydrofluoric acids. Once you have finished grouting, remove any excess material before it has the chance to harden. We recommend the use of a slightly acidic detergent that does not give off any toxic fumes and will not affect either the grouting itself, the material or the user, such as Fila Deterdek. In the case of epoxy resin grouts, we recommend the use of a specific epoxy residue cleaner such as Fila CR10.

Après la pose, il est fondamental d'effectuer un bon nettoyage pour éliminer les résidus de jointoiment et en général la saleté des travaux en évitant l'emploi de produits abrasifs comme les acides fluorhydriques. À la fin du processus de jointoiment, retirer le matériau en excès avant qu'il durcisse. Il est recommandé d'utiliser un décapant à action légèrement acide qui ne dégage pas de fumées nocives et respecte les jointoiments, le matériau et l'utilisateur, comme Fila Deterdek. En cas de jointoiments de résines époxy, il est souhaitable d'employer un nettoyant spécifique de résidus époxy comme Fila CR10.

Después de la colocación es fundamental realizar una buena limpieza para eliminar residuos de junta y en general suciedad de la obra evitando el uso de productos abrasivos como ácidos fluorhídricos. Una vez finalizado el proceso de rejuntado debemos retirar el material sobrante antes de que se endurezca. Te aconsejamos el empleo de un detergente de acción ligeramente ácida que no despidan humos tóxicos y respete las juntas, el material y el usuario, como Fila Deterdek. En el caso de juntas de resina epoxi se aconseja utilizar un limpiador específico de residuos epoxi, como Fila CR10.

Nach dem Verlegen ist eine gründliche Reinigung erforderlich, um Fugenmaterialreste und allgemeine Verunreinigungen durch die Bauarbeiten zu entfernen. Dabei dürfen keine ätzenden Produkte wie Fluorwasserstoffsäuren verwendet werden. Nach dem Verfugen muss überschüssiges Material entfernt werden, bevor es aushärtet. Wir empfehlen die Verwendung eines leicht säurehaltigen Reinigungsmittels, das keine giftigen Dämpfe entwickelt und Fugen, Material und Anwender schont, wie zum Beispiel Fila Deterdek. Im Fall von Fugen aus Epoxidharz empfiehlt sich die Verwendung eines speziellen Reinigers für Epoxy-Rückstände, zum Beispiel Fila CR10.



Choose a specific cleaning product | Selecciona un limpiador específico | Sélectionner un nettoyant spécifique | Wählen Sie einen speziellen Reiniger



Remove any leftover grout and other dirt | Elimina los residuos de junta y demás suciedad | Éliminer les résidus de jointoiment et autres saletés | Entfernen Sie Fugenmaterialreste und andere Verunreinigungen

18 OBSERVE THE DRYING TIMES GIVEN BY THE MANUFACTURER RESPETA EL TIEMPO DE SECADO INDICADO POR EL FABRICANTE | RESPECTER LE TEMPS DE SÉCHAGE INDIQUÉ PAR LE FABRICANT | HALTEN SIE DIE VOM HERSTELLER ANGELEGEBENE TROCKENZEIT EIN



Observe the drying time | Respeta el tiempo de secado | Respecter le temps de séchage | Halten Sie die Trockenzeit ein

Although each manufacturer gives a specific drying time for adhesive cement, in general terms it should be left to dry for at least 24 hours, after which you can start the grouting process.

Aunque cada fabricante especifica el tiempo de secado del cemento cola, por lo general lo dejaremos secar al menos 24 horas, y tras este plazo de tiempo, procederemos al proceso de rejuntado.

Bien que chaque fabricant spécifie le temps de séchage du ciment colle, en général laisser sécher pendant au moins 24 heures, puis procéder au jointoiment.

Die Trockenzeit des Zementklebers wird zwar von jedem Hersteller angegeben, doch im Allgemeinen lassen wir ihn mindestens 24 Stunden trocknen, um nach Ablauf dieser Zeit zu verfugen.

19 RECYCLING RECICLA | RECYCLER | RECYCLING



Follow the rules of waste management | Sigue la normativa de gestión de residuos | Suivez les règles de gestion des déchets | Folgen Sie den Regeln der Abfallwirtschaft

All our packaging and products are recyclable, so we recommend you dispose of them at the appropriate selective collection points. Please deal with them according to the waste management regulations applicable in your country, specifically those for packaging waste and ceramic claddings.

Tanto nuestros envases como nuestros productos son reciclables por lo que te recomendamos que utilices los puntos de recogida selectiva. Gestiónalos según la normativa de gestión de residuos y con las premisas específicas para "residuos de envases" y "recubrimientos cerámicos" aplicables en tu país.

Tous nos emballages et tous nos produits sont recyclables. Il est recommandé d'utiliser les points de collecte séparée. Les gérer conformément à la réglementation concernant la gestion des déchets et aux dispositions sur les "déchets d'emballage" et les "revêtements céramiques" en vigueur dans chaque pays.

Unsere Verpackungen und Produkte sind wiederverwertbar. Wir empfehlen Ihnen deshalb, sie an Wertstoff-Annahmestellen zu entsorgen. Die Entsorgung muss gemäß den in Ihrem Land anwendbaren Abfallmanagementvorschriften unter den spezifischen Voraussetzungen für "Verpackungsrückstände" und "Keramikfliesen" erfolgen.

AFTER LAYING THE TILES DESPUÉS DE LA COLOCACIÓN | APRÈS LA POSE | NACH DEM VERLEGEN

To ensure the optimum condition of the ceramic tiles and any special features during their lifespan, once they have been installed according to our recommendations you should follow the cleaning and maintenance instructions provided to avoid damaging the ceramic and to maintain its beautiful appearance.

We recommend you take great care to maintain your ceramic products frequently, protecting them from any aggressive elements or environments and making sure to avoid the use of abrasive cleaning products and methods.

To get rid of general dirt on ceramic floors and walls you can use hot water, cloths or sponges, mops or organic solvents; never use scouring pads (except for the very first clean after laying to remove resistant materials). Always follow the manufacturers' instructions in the case of specific cleaning products and avoid the use of hydrochloric acids. In the case of tiles with metal features, we recommend you avoid the use of cleaning products that contain acids.

Due to the habitual use of the ceramic tiles they may come into contact with a specific type of dirt that calls for more specific cleaning. There are a huge variety of products on the market for each type of stain, and you should pay attention to the recommendations for use and, if necessary, ask for further advice.

Para asegurar el buen estado de las baldosas cerámicas y piezas especiales durante todo el período de uso, una vez instaladas siguiendo nuestras recomendaciones, es necesario seguir las indicaciones de limpieza y mantenimiento para no dañar el producto cerámico y mantener su belleza intacta.

Se recomienda prestar un cuidado frecuente en el mantenimiento habitual de las piezas cerámicas, conservándolas y protegiéndolas de elementos o ambientes agresivos y evitando métodos y productos de limpieza abrasivos.

Para eliminar la suciedad general en pavimento y revestimiento se puede utilizar agua caliente, paños o esponjas, mopas, fregonas o disolventes orgánicos; nunca estropajos (salvo en la primera limpieza de obra en materiales resistentes). Se deben seguir las instrucciones de los fabricantes en el caso de limpiadores específicos y se ha de evitar el uso de ácidos clorhídricos. En el caso de piezas con aplicaciones de metales se recomienda evitar el uso de limpiadores con ácidos.

Debido a un uso habitual las piezas pueden entrar en contacto con suciedad más específica que requiere una limpieza más particular. En el mercado existe una gran variedad de productos específicos para cada tipo de manchas, se debe prestar atención a las recomendaciones de uso y si es necesario, solicitar indicaciones.

Pour assurer le bon état des dalles céramiques et des pièces spéciales durant toute la période d'utilisation, après les avoir posées selon nos recommandations, il est nécessaire de suivre les indications de nettoyage et d'entretien pour ne pas endommager le produit céramique et pour maintenir leur beauté intacte.

L'entretien habituel des pièces céramiques exige un soin fréquent en les conservant et en les protégeant d'éléments ou ambiances agressifs et en évitant des méthodes et des produits de nettoyage abrasifs.

Pour éliminer la saleté générale des pavements et des revêtements, l'eau chaude, des chiffons ou des éponges, des balais à franges, des serpillères ou des dissolvants organiques peuvent être utilisés ; ne jamais employer de tampons à récurer (sauf pour le premier nettoyage des matériaux résistants lors des travaux). Respecter les instructions des fabricants dans le cas des nettoyants spécifiques et éviter l'usage d'acides chlorhydriques. Dans le cas de pièces avec applications de métaux, il est recommandé d'éviter l'emploi de nettoyants avec acides.

Dans le cadre de leur utilisation habituelle, les pièces peuvent entrer en contact avec la saleté la plus spécifique qui exige un nettoyage plus particulier. Il existe sur le marché beaucoup de produits spécifiques pour chaque type de taches. Il est nécessaire de respecter les recommandations d'emploi et, le cas échéant, demander des instructions.

Zur Gewährleistung des tadellosen Zustands nach unseren Empfehlungen verlegten Keramik- und Sonderfliesen während der gesamten Nutzungsdauer müssen die Reinigungs- und Pflegehinweise beachtet werden, um das Keramikprodukt nicht zu beschädigen und seine Schönheit zu bewahren. Es wird empfohlen, sich regelmäßig der gewohnten Pflege der Keramikfliesen zu widmen, um sie instandzuhalten und vor aggressiven Elementen und Umgebungen zu schützen. Dabei keine scheuernden Reinigungsprodukte und Methoden verwenden.

Zum Entfernen von allgemeinen Verunreinigungen an Boden- und Wandfliesen können heißes Wasser, Tücher oder Schwämme, Mopps, Wischmopps oder organische Lösungsmittel verwendet werden. Keine Scheuerschwämme benutzen (außer bei der Erstreinigung strapazierfähiger Fliesen). Bei speziellen Reinigungsmitteln sind die Anweisungen der Hersteller einzuhalten. Chlorwasserstoffsäuren dürfen nicht verwendet werden. Im Fall von Fliesen mit Metalldekor sollte eine Reinigung mit säurehaltigen Reinigungsmitteln vermieden werden.

Bei gewöhnlichem Gebrauch können die Fliesen von spezifischeren Verunreinigungen betroffen sein, die eine besondere Reinigung erfordern. Im Handel ist eine große Auswahl an speziellen Produkten für jeden Fleckentyp erhältlich. Hier sind die Gebrauchsempfehlungen zu beachten. Gegebenenfalls Anweisungen erfragen.

TYPE OF EMBEDDED DIRT TIPO DE SUCIEDAD INCRUSTADA TYPE DE SALETÉ INCRUSTÉE ART DER VERUNREINIGUNG	RECOMMENDED PRODUCT PRODUCTO A UTILIZAR PRODUIT À UTILISER ZU VERWENDENDENES PRODUKT
Acrylic sprays Sprays acrílicos Sprays acryliques AcrylZsprays	FILANOPAINT STAR
Adhesive cement residue Residuos de cemento de colocación Résidus de ciment de pose Fliesenkleberrückstände	DETERDEK
Alkyd and nitro-synthetic enamels Esmaltes alquídicos y nitro sintéticos Émaux alkyles et nitrosynthétiques Alkydharzacke und synthetische Nitrolacke	FILANOPAINT STAR
Epoxy resin grout residue, vitrified or resinous residue Residuos de junta epoxi, vitrificada, resinosa Résidus de jointoiment époxy, vitrifié, résineux Rückstände von epoxid- und harzhaltigen sowie keramisierten Fugenmassen	FILACR10
Felt-tip pen ink Tinta de rotulador Encre de marqueurs Filzstift	FILAPS87
Glue residue Residuos de pegamento Résidus de colle Klebstoffrückstände	FILAZERO SIL
Graffiti paint Pintadas de graffiti Peintures de graffitis Graffiti	FILANOPAINT STAR
Heavy organic dirt: food, grease, oils Suciedad orgánica intensa: comidas, grasas, aceites Saleté organique intense : nourriture, graisses, huiles Starke organische Verschmutzungen: Essensreste, Fett, Öl	FILAPS87
Inks/dyes Tintes Encres Färbemittel	FILAPS87
Interior mould from condensation Moho interior por condensación Moisissure intérieure par condensation Schimmel in Innenräumen durch Kondensation	FILAACTIVE 1
Light organic dirt (daily cleaning) Suciedad orgánica ligera (limpieza diaria) Saleté organique légère (nettoyage quotidien) Leichte organische Verschmutzungen (tägliche Reinigung)	FILACLEANER
Lime scale Residuos calcáreos Résidus calcaires Kalkrückstände	DETERDEK
Metal scratches Rayas metales Éraflures de métaux Metallkratzer	DETERDEK
Plastic paint Pintura plástica Peinture plastique Plastikfarbe	FILAPS87
Polyurethane foam residue Residuos de cinta adhesiva Résidus de bande adhésive Klebebandrückstände	FILAZERO SIL
Residuos de detergentes y jabones Soap or detergent residue Résidus de détergents et de savons Rückstände von Waschmitteln und Seifen	FILAPS87
Residuos de espuma poliuretánica Polyurethane foam residue Résidus de mousse polyuréthane Rückstände von Polyurethanschaum	FILAZERO SIL
Rubber, tyre marks Goma, neumáticos Caoutchouc, pneumatiques Gummi, Reifen	FILAPS87
Rust deposits Depósitos de óxidos Dépôts d'oxydes Rostablagerungen	DETERDEK
Silicone residue Residuos de silicona Résidus de silicone Silikonrückstände	FILAZERO SIL
Tree sap Resina de árboles Résine d'arbres Baumharz	FILAZERO SIL
Verdigris, algae, moss, lichen and exterior blackening Verdín, algas, musgos, líquenes y ennegrecidos exteriores Voile gras, algues, mousses, lichens et traces noires extérieures Grünspan, Algen, Moos, Flechten und schwarze Flecken in Außenbereichen	FILAALGAE NET

<p>MAINTENANCE MANTENIMIENTO ENTRETIEN PFLEGE</p>
--

Before attempting to remove a stain with aggressive agents, we recommend you check its effect on a small area of the tiling and grouting in a perimeter area out of sight in order to avoid any deterioration or significant changes in the surface of the tile.

Whatever the case, it is advisable to provide the client with information on which cleaning agents are recommended for removing stains and any adhesive materials used in laying the tiles. You should pay particular attention to both the initial cleaning and subsequent maintenance of polished floors and wall claddings.

In the case of polished porcelain flooring, the polishing process opens up the surface micro-pores of the tiles which means they are more susceptible to staining from certain liquids.

For polished porcelain floors it is very important that any agent which might affect them (oils, fizzy drinks, alcoholic drinks and acids) are cleaned with water as soon as possible to avoid longer exposure of the tiles and the agent staining them irrevocably. If the stain is left for a long time, it is possible that the flooring itself will be affected. For optimum maintenance, we recommend the use of a neutral detergent with high cleaning power such as FilaCleaner.

En aquellos pavimentos porcelánicos pulidos, es muy importante que cualquier agente que pudiera afectarlos (aceites, bebidas gaseosas, bebidas alcohólicas, y ácidos), sean limpiados con agua, a la mayor brevedad posible, para evitar el mayor tiempo de exposición sobre las piezas, y que el agente, manche el pavimento. De permanecer en exposición la mancha durante mucho tiempo, es posible que el pavimento, acabe afectado. Para un buen mantenimiento del pavimento se aconseja el empleo de un detergente neutro de alto poder limpiador como FilaCleaner.

Vor dem Versuch, Flecken mit aggressiven Mitteln zu entfernen, sollte man die Auswirkungen auf die Wand- / Bodenfliesen und das Fugenmaterial an einer kleinen, nicht sichtbaren Stelle testen, um Farb- oder Oberflächenveränderungen an der Fliese vorzubeugen.

In jedem Fall sollten für den Kunden Informationen über empfohlene Reinigungsmittel zur Entfernung von Flecken und beim Verlegen verwendetem Haftmaterial bereitgestellt werden. Bei der Anfangsreinigung und der späteren Pflege ist im Fall von polierten Boden- und Wandfliesen besonders vorsichtig vorzugehen.

Bei polierten Bodenfliesen werden beim Polieren die Mikroporen an der Oberfläche geöffnet. Dadurch reagieren sie beim Kontakt mit bestimmten Flüssigkeiten besonders fleckenempfindlich.

Bei diesen polierten Bodenfliesen ist es äußerst wichtig, alle Fleckenauslöser (Öl, kohlen säurehaltige Getränke, alkoholische Getränke und Säuren) so rasch wie möglich mit Wasser zu entfernen, um eine längere Einwirkzeit auf die Fliesen und eine Fleckenbildung zu verhindern. Bei längerer Einwirkzeit können die Fliesen beeinträchtigt werden. Für die korrekte Pflege der Bodenfliesen wird ein Neutralreiniger mit hoher Reinigungskraft wie FilaCleaner empfohlen.

Aucune réclamation sur le produit installé ne sera admise ni de laquelle il ressort tout manquement aux recommandations et conseils de pose ainsi qu'aux instructions susmentionnées.

<p>SPECIAL PIECES PIEZAS ESPECIALES PIÈCES SPÉCIALES SONDERFLIESEN</p>

Any special complementary pieces that contain metals (gold, silver, copper, etc.), lustres, crushed frits, resins, glass, etc., may have specific characteristics (slight variations in shade, oxidation on contact with the air or moisture, an aged appearance with the passage of time, etc.).

Rectified and/or meshed tiles must be handled with great care to prevent chipping on their edges or scratches on the surface. When laying glass listels, use non-acetic silicones or adhesives from class C2 and D2. Complementary pieces are not suitable for outdoor installation, except for those that are attached to a matching based and have been recommended for exteriors.

CLEANING THE SITE: Do not allow adhesive material to harden on the piece (clean within 24 hours). Remove any surplus laying material (cements, grout, etc.) with a sponge and plenty of water. Do not use any abrasive products or those with an acid or alkaline base to avoid damaging the surface or the appearance of the tile. Do not use products containing hydrochloric acid or scouring pads that may damage the surface of the tiles.

MAINTENANCE: to clean the tiles, do not use powder-based detergents, acidic or alkaline solutions, scouring pads or abrasive elements. The use of a damp cloth with a neutral liquid soap is sufficient.

No claims will be accepted in relation to installed material where there is evidence that the laying and maintenance instructions given above have not been adhered to.

Es recomendable antes de intentar eliminar una mancha con agentes agresivos, comprobar su efecto sobre la superficie del revestimiento / pavimento y el material rejuntado, en una zona acotada no visible para prevenir degradaciones o cambios significativos sobre la superficie de la baldosa.

En cualquier caso, es aconsejable facilitar información al cliente sobre que agentes de limpieza son los recomendables para la eliminación de las manchas y los materiales de agarre utilizados en la colocación. Prestaremos especial atención tanto en la limpieza inicial como en el mantenimiento posterior en los pavimentos y revestimientos pulidos.

A los pavimentos porcelánicos pulidos, durante el proceso de pulido, se les abre el microporo de la superficie, lo que significa, que son más susceptibles de ser manchados por determinados líquidos.

En aquellos pavimentos porcelánicos pulidos, es muy importante que cualquier agente que pudiera afectarlos (aceites, bebidas gaseosas, bebidas alcohólicas, y ácidos), sean limpiados con agua, a la mayor brevedad posible, para evitar el mayor tiempo de exposición sobre las piezas, y que el agente, manche el pavimento. De permanecer en exposición la mancha durante mucho tiempo, es posible que el pavimento, acabe afectado. Para un buen mantenimiento del pavimento se aconseja el empleo de un detergente neutro de alto poder limpiador como FilaCleaner.

Vor dem Versuch, Flecken mit aggressiven Mitteln zu entfernen, sollte man die Auswirkungen auf die Wand- / Bodenfliesen und das Fugenmaterial an einer kleinen, nicht sichtbaren Stelle testen, um Farb- oder Oberflächenveränderungen an der Fliese vorzubeugen.

In jedem Fall sollten für den Kunden Informationen über empfohlene Reinigungsmittel zur Entfernung von Flecken und beim Verlegen verwendetem Haftmaterial bereitgestellt werden. Bei der Anfangsreinigung und der späteren Pflege ist im Fall von polierten Boden- und Wandfliesen besonders vorsichtig vorzugehen.

Bei polierten Bodenfliesen werden beim Polieren die Mikroporen an der Oberfläche geöffnet. Dadurch reagieren sie beim Kontakt mit bestimmten Flüssigkeiten besonders fleckenempfindlich.

Bei diesen polierten Bodenfliesen ist es äußerst wichtig, alle Fleckenauslöser (Öl, kohlen säurehaltige Getränke, alkoholische Getränke und Säuren) so rasch wie möglich mit Wasser zu entfernen, um eine längere Einwirkzeit auf die Fliesen und eine Fleckenbildung zu verhindern. Bei längerer Einwirkzeit können die Fliesen beeinträchtigt werden. Für die korrekte Pflege der Bodenfliesen wird ein Neutralreiniger mit hoher Reinigungskraft wie FilaCleaner empfohlen.

Aucune réclamation sur le produit installé ne sera admise en suivant la législation en vigueur.

<p>LIMPIEZA DE OBRA: Evitar el fraguado del material de colocación sobre la pieza (limpiar antes de 24 horas). Retirar los restos del material de colocación (cementos, rejunte, etc.) con una esponja y abundante agua. No usar ningún producto abrasivo, ni aplicación con base ácida ni alcalina, para evitar cualquier pérdida de aspecto o ataque superficial. No utilizar productos con ácido clorhídrico ni tampoco estropajos que puedan deteriorar la superficie de las piezas.</p>

En piezas especiales complementarias donde se hayan utilizado metales (oro, plata, cobre,...), lustres, granillas, resinas, cristal, etc, pueden presentar características particulares (ligeras variaciones de tonalidad, oxidación al contacto con el aire y la humedad, aspecto envejecido con el paso del tiempo,...)

En materiales rectificadods y/o enmallados se requiere manipular con cuidado para prevenir desconchados en sus bordes y rayados superficiales. Para la colocación de listelos de cristal utilizar siliconas o colas no acéticas de clase C2 y D2. Las piezas complementarias no son aptas para su instalación en exteriores, excepto aquellas que nacen de su base y esta sí está recomendada para su colocación en zonas exteriores.

LIMPIEZA DE OBRA: Evitar el fraguado del material de colocación sobre la pieza (limpiar antes de 24 horas). Retirar los restos del material de colocación (cementos, rejunte, etc.) con una esponja y abundante agua. No usar ningún producto abrasivo, ni aplicación con base ácida ni alcalina, para evitar cualquier pérdida de aspecto o ataque superficial. No utilizar productos con ácido clorhídrico ni tampoco estropajos que puedan deteriorar la superficie de las piezas.

MANTENIMIENTO: para la limpieza de las piezas, no utilizar detergentes en polvo, ni soluciones ácidas, ni alcalinas, ni estropajos, ni elementos abrasivos. Es suficiente una bayeta húmeda y jabón líquido neutro.

No se aceptará reclamación de producto instalado y de la cual se evidencie que no se han seguido los consejos de colocación y las instrucciones anteriormente citadas.

Des pièces spéciales complémentaires où il a été utilisé des métaux (or, argent, cuivre,...), glaçures, granulés, résines, verre, etc., peuvent présenter des caractéristiques particulières (légères variations de couleurs, oxydation au contact de l'air et de l'humidité, aspect vieilli au fil du temps,...)

Les matériaux rectifiés et/ou sur maille doivent être manipulés avec soin pour prévenir des fêlures sur leurs bords et des rayures superficielles. Pour la pose de listels en verre, utiliser des silicones ou des colles non acétiques de classe C2 et D2. Les pièces complémentaires ne sont pas aptes pour leur installation à l'extérieur à l'exception de celles qui naissent de leur base et si celle-ci est recommandée pour leur pose en extérieur.

NETTOYAGE DE CHANTIER : éviter la prise du matériau de pose sur la pièce (nettoyer sous 24 heures). Retirer les restes du matériau de pose (mortier, jointoiment, etc.) à l'aide d'une éponge et à grande eau. N'utiliser aucun produit abrasif, ni application à base acide ni alcaline, afin d'éviter toute perte d'aspect ou toute attaque superficielle. Ne pas utiliser de produits contenant de l'acide chlorhydrique ni de tampons à récurer qui peuvent détériorer la superficie des pièces.

ENTRETIEN : pour le nettoyage des pièces, ne pas utiliser de détergents en poudre, ni de solutions acides, ni alcalines, ni de tampons à récurer, ni d'éléments abrasifs. Il suffit d'un chiffon humide et de savon liquide neutre.

Aucune réclamation sur le produit installé ne sera admise ni de laquelle il ressort tout manquement aux recommandations et conseils de pose ainsi qu'aux instructions susmentionnées.

<p>AFTER-SALES SERVICE SERVICIO POST-VENTA SERVICE APRÈS-VENTE KUNDENDIENST</p>
--

<p>Keraben Grupo recommends that all works are undertaken in accordance with the UNE 13800:2017 standard on the general regulations for laying ceramic tiles with an adhesive agent.</p>

According to the CTE (the Spanish Technical Building Code) it is the direct responsibility of the site foreman or, in his absence, the buyer, to check and supervise all the material supplied (its quality, the state of the packaging, that the documents provided correspond to the product delivered, etc.).

No claims will be accepted in relation to the installed product in accordance with curent legislation. Any anomaly in product quality must be notified to the Sales Department. To make any complaint about the product, you should state the model, format, tone, calibre, physical products tests, the product identification tag on the packaging and the purchase invoice, as well as any other evidence that may be relevant to reach a decision concerning the complaint.

Claims will not be accepted in cases where the recommendations for the installation and use of our products have not been followed.

<p>REKLAMATIONEN BEI VERLEGTEN PRODUKTEN WERDEN ABGEWIESEN, WENN DIE VERLEGUNGSTIPPS UND OBIGEN HINWEISE OFFENSICHTLICH NICHT BEFOLGT WURDEN.</p>
--

Keraben Grupo recommande d'effectuer tous les travaux conformément aux dispositions de la norme UNE 13800:2017 sur les règles générales pour l'exécution de dalles en céramique par adhérence.

Selon le CTE (Code technique de la construction), le maître d'œuvre ou, à défaut, l'acheteur, est responsable de la supervision et du contrôle du matériau fourni (qualité, état de l'emballage, coïncidence entre la documentation remis et le produit livré, etc.).

Aucune réclamation sur le produit installé ne sera admise en suivant la législation en vigueur. Toute anomalie sur la qualité du produit devra être signalée au Département Commercial. Toute réclamation relative au produit devra indiquer le modèle, format, couleur, calibre, preuves physiques du produit, telle que l'étiquette d'identification du produit sur son emballage et la facture d'achat ainsi que toute autre preuve d'intérêt pour statuer.

Aucune réclamation ne sera admise sur les cas pour lesquelles les recommandations de pose, d'utilisation et d'entretien de nos produits n'auront pas respectées.

Sonderfliesen mit Verarbeitung von Metallen (Gold, Silber, Kupfer ...), Polituren, Granalien, Harzen, Glas etc., können besondere Merkmale aufweisen (leichte Farbunterschiede, Oxidation bei Kontakt mit Luft und Feuchtigkeit, Alterungserscheinungen im Lauf der Zeit ...).

Bei Materialien mit Kantenschliff und/oder Gewebeverklebung ist ein besonders vorsichtiger Umgang erforderlich, um Abbruch an den Rändern und Oberflächenkratzern vorzubeugen. Bei der Verlegung von Glasbordüren sind Silikone oder Kleber ohne Essigsäure der Klasse C2 und D2 zu verwenden. Sonderfliesen sind nicht für Außenbereiche geeignet. Eine Ausnahme bilden jene, deren Basisteil für die Verlegung im Freien geeignet ist.

ERSTREINIGUNG: Das Aushärten von Verlegematerial auf den Fliesen ist zu vermeiden (Reinigung innerhalb von 24 Stunden). Reste von Verlegematerial (Zemente, Fugenmaterial etc.) mit einem Schwamm und reichlich Wasser entfernen. Keine Scheuermittel und säure- oder alkalihaltigen Reinigungsmittel verwenden, um jegliche Beeinträchtigung des Aussehens zu vermeiden und die Unversehrtheit der Oberfläche zu bewahren. Keine chlorwasserstoffsäurehaltigen Produkte oder Scheuerschwämme verwenden, die die Oberfläche der Fliesen beschädigen könnten.

PFLEGE: Für die Fliesenreinigung keine Reinigungsmittel in Pulverform, Ätzwässigkeiten, Laugen, Scheuerschwämme oder sonstige abrasive Elemente verwenden. Ein feuchtes Tuch und flüssige Neutralseife reichen aus.

Reklamationen bei verlegten Produkten werden abgewiesen, wenn die Verlegungstipps und obigen Hinweise offensichtlich nicht befolgt wurden.

<p>REKLAMATIONEN BEI VERLEGTEN PRODUKTEN WERDEN ABGEWIESEN, WENN DIE VERLEGUNGSTIPPS UND OBIGEN HINWEISE OFFENSICHTLICH NICHT BEFOLGT WURDEN.</p>
--

<p>REKLAMATIONEN BEI VERLEGTEN PRODUKTEN WERDEN ABGEWIESEN, WENN DIE VERLEGUNGSTIPPS UND OBIGEN HINWEISE OFFENSICHTLICH NICHT BEFOLGT WURDEN.</p>
--

Keraben Grupo recomienda que todas las obras se realicen siguiendo las indicaciones de la Norma UNE 13800:2017 Reglas Generales para la ejecución de baldosas cerámicas por adherencia.

Según el CTE (Código Técnico de la Edificación) es responsabilidad directa de la figura del director de obra o en su defecto del comprador, la supervisión y comprobación del material suministrado (calidad del mismo, estado del embalaje, coincidencia entre la documentación suministrada y el producto de servido, etc.).

No se aceptarán reclamaciones sobre producto instalado, atendiendo a la Legislación Vigente. Cualquier anomalía en la calidad del producto deberá ser comunicada al Departamento Comercial. Para formular reclamación del producto será necesario indicar modelo, formato, tono, calibre, pruebas físicas del producto, como la solapa identificativa del producto en su envase y la factura de compra, así como cualquier otra evidencia, que sea interesante para decidir al respecto.

No se aceptarán reclamaciones en aquellos casos en los que no se hayan seguido las recomendaciones que hacemos constar para la instalación uso y mantenimiento de nuestros productos.

Keraben Grupo empfiehlt, alle Baumaßnahmen unter Einhaltung der Norm UNE 13800:2017 (Allgemeine Regeln für die Verklebung von keramischen Bodenfliesen) durchzuführen.

Gemäß der spanischen Bauvorschrift CTE (Código Técnico de la Edificación) obliegt die direkte Verantwortung für die Überwachung und Prüfung des gelieferten Materials dem Bauleiter oder ansonsten dem Käufer (Materialqualität, Zustand der Verpackung, Übereinstimmung von Lieferunterlagen und geliefertem Material etc.).

Im Einklang mit der geltenden Gesetzgebung werden keine Reklamationen von bereits verlegten Produkten entgegengenommen. Jegliche Anomalie bei der Produktqualität ist der Verkaufsabteilung zu melden. Für eine Reklamation ist die Angabe von Modell, Format, Farbton, Kaliber, physikalischen Prüfungen des Produkts sowie der Produktidentifikationslasche auf der Verpackung, der Rechnung und sonstigen Auffälligkeiten erforderlich, um eine diesbezügliche Entscheidung zu erleichtern.

Reklamationen von Fällen, bei denen unsere Empfehlungen für Verlegung, Gebrauch und Pflege unserer Produkte nicht beachtet wurden, werden nicht entgegengenommen.



SPECIAL TILE PIECES

PIEZAS ESPECIALES | PIÈCES SPÉCIALES | SONDERTEILE

ROUNDED EDGE SKIRTING | RODAPIÉ

8X75 | 8X60 | 8X50
3"X30" | 3"X24" | 3"X20"

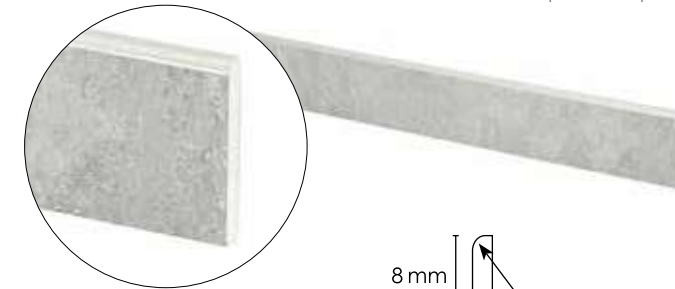

8 mm
half round | romado

STEP | PELDAÑO SIMPLE

100X50 | 100X24,8 | 37X75 | 30X60
40"X20" | 40"X10" | 15"X30" | 12"X24"

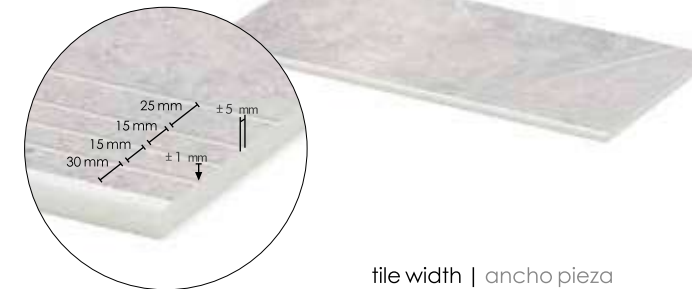

tile width | ancho pieza

half round | romado

DOUBLE STEP | PELDAÑO DOBLE

150X37 | 100X50 | 100X24,8 | 37X75 | 30X60
60"X15" | 40"X20" | 40"X10" | 15"X30" | 12"X24"



tile width | ancho pieza

34,5 mm | 24,2 mm
33,2 mm

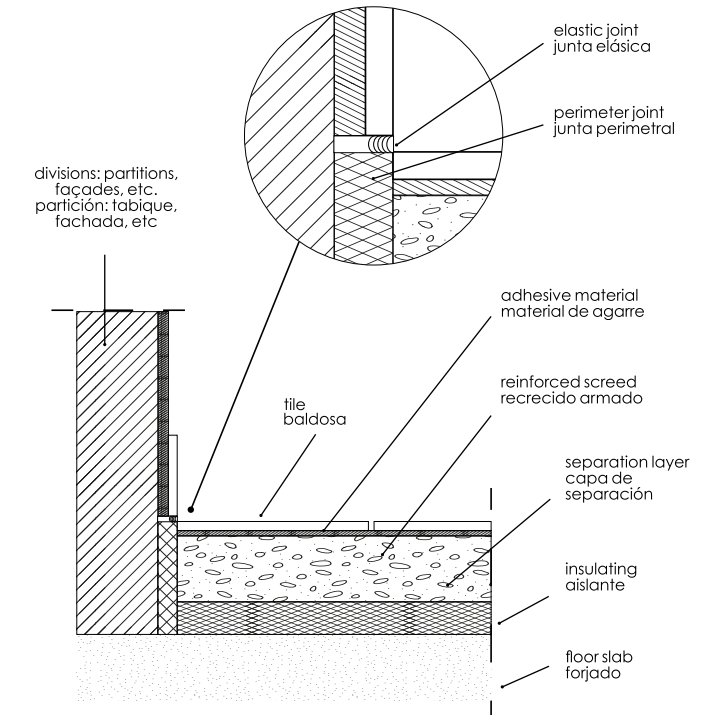

DETAIL OF PERIMETER JOINT WITH SEALANT | DETALLE DE JUNTA PERIMETRAL CON SELLANTE (UNE 138002:2017)

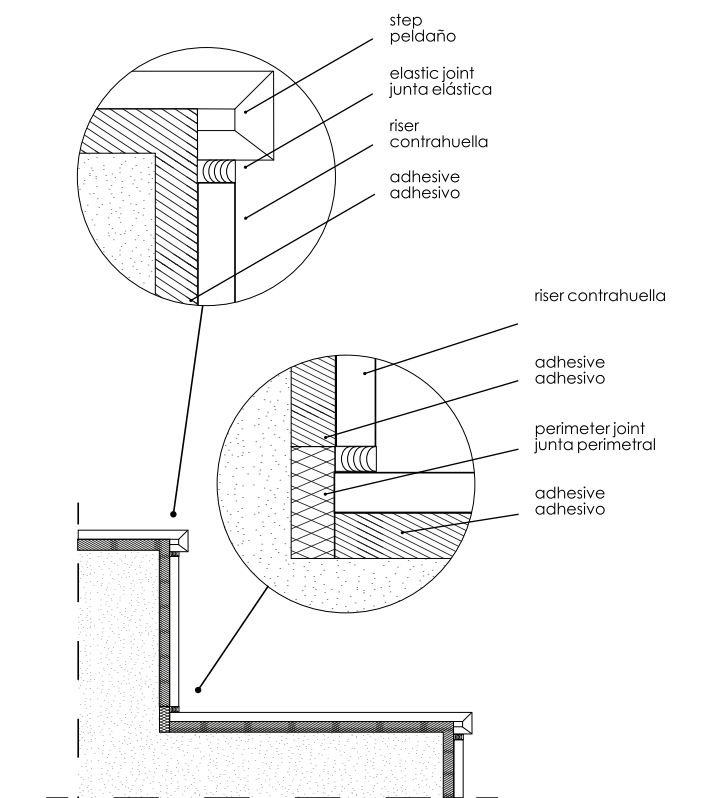

DETAIL OF STEPS ON A STAIRCASE | DETALLE DE PELDAÑOS EN ESCALERA (UNE 138002:2017)



FROM DRAWING TO REALITY



KERABEN 3D

www.keraben.com

KERABEN offers you a simple and innovative design program, completely free of charge, enabling you to personalise your settings and make the most of our textures, reliefs, shade variations, colours and formats.

KERABEN pone a tu disposición, de forma gratuita, un sencillo y novedoso programa de diseño para que puedas personalizar tus ambientes y sacar el máximo partido a nuestras texturas, relieves, destonificados, colores, formatos.

KERABEN met à votre disposition, gratuitement, un programme de design, simple et innovant, afin que vous puissiez personnaliser vos ambiances et tirer le plus grand profit de nos textures, reliefs, nuances de couleurs, couleurs et formats.

KERABEN bietet Ihnen kostenlos ein einfaches und neuartiges Designprogramm, mit dem Sie Ihre Ambiente personalisieren und unsere Texturen, Reliefs, Farbschattierungen, Farben und Formate maximal nutzen können.

1 DOWNLOAD THE APPLICATION DESCARGA EL APLICATIVO | TÉLÉCHARGEMENT DE L'APPLICATION | APPLIKATION DOWNLOADEN

Available from our website at www.keraben.com, it will install a folder on your PC where you can file all your projects. Podrás hacerlo desde nuestra Web www.keraben.com, creará en tu PC una carpeta donde podrás almacenar todos tus proyectos. Vous pourrez le faire depuis notre site Web www.metropol-ceramica.com, cela créera un dossier au sein de votre ordinateur, où vous pourrez sauvegarder tous vos projets. Sie können die App von unserer Website www.keraben.com herunterladen. Diese erstellt in Ihrem PC eine Mappe, in der Sie Ihre Projekte speichern können.

2 SELECT A PLAN AND INSERT YOUR MEASUREMENTS SELECCIONA UN PLANO E INSERTA TUS MEDIDAS | SÉLECTIONNEZ UN PLAN ET INSÉREZ VOS MESURES | WÄHLEN SIE EINEN PLAN UND GEBEN SIE IHRE ABMESSUNGEN EIN

Select an existing plan or draw your own, quickly and easily. Selecciona uno existente o dibuja de forma rápida y sencilla tu propio plano. Sélectionnez un plan existant ou dessinez rapidement et simplement votre propre plan. Wählen Sie einen vorhandenen Plan oder zeichnen Sie schnell und einfach Ihren eigenen.

3 ADD FURNITURE AGREGA MOBILIARIO | AJOUTEZ LE MOBILIER | MOBILIAR EINFÜGEN

Just by selecting and dragging you can add the accessories you consider necessary. Sólo con pinchar y arrastrar podrás incorporar todo el atrezzo que consideres. Il vous suffit de cliquer et d'entraîner le mobilier de votre choix sur le plan pour l'y incorporer. Sie können jedes gewünschte Zubehör einfach anklicken und auf den Plan ziehen.

4 INCLUDE THE ITEMS OF YOUR CHOICE FROM OUR CATALOGUE INCLUYE LAS PIEZAS QUE DESEES DE NUESTRO CATÁLOGO | CELA INCLUT LES PIÈCES QUE VOUS SOUHAITEZ DE NOTRE CATALOGUE | GEBEN SIE DIE GEWÜNSCHTEN FLIESENTEILE AUS UNSEREM KATALOG EIN

Mix and match as you wish to design your settings; switch to 3D mode for a view of how it will really look. Combinálas a tu gusto para diseñar tus ambientes, cambia al modo 3d para tener una vista real. Combinez-les comme bon vous semble pour créer vos ambiances, passez en mode 3d pour obtenir une vue réelle. Kombinieren Sie sie ganz nach Wunsch, um Ihre Ambiente zu schaffen, und wechseln Sie zum 3D-Modus, um eine realistische Ansicht zu bekommen.

5 SELECT THE VIEW OF YOUR CHOICE AND TAKE A PHOTOGRAPH OF THE SETTING ELIGE LA VISTA QUE QUIERAS Y TOMA UNA FOTOGRAFÍA DEL AMBIENTE | CHOISISSEZ LA VUE QUE VOUS SOUHAITEZ ET PRENEZ UNE PHOTOGRAPHIE DE L'AMBIANCE | WÄHLEN SIE DIE GEWÜNSCHTE ANSICHT UND MACHEN SIE EIN FOTO VOM AMBIENTE

Turn the camera in the setting as you wish to select the most attractive view of your project. Gira la cámara dentro del ambiente como desees para seleccionar la vista más atractiva de tu proyecto. Faites tourner le viseur au sein de l'ambiance comme bon vous semble pour choisir la vue la plus attrayante de votre projet. Drehen Sie die Kamera nach Wunsch innerhalb des Ambientes, um die schönste Ansicht Ihres Projekts zu wählen.



WE BELIEVE IN OUR PLANET

CREAMOS EN NUESTRO PLANETA | SOMMAIRE USAGE | INHALTSANGABE NACH VERWENDUNGSMÖGLICHKEITEN

Earth, water and fire: three essential elements in the manufacture of ceramic tiles and the reason why we are committed to caring for our planet. This has been our philosophy since the very beginnings of the company and we apply it to each and every stage of the business. This commitment is the reason for the environmental self-declaration we published under the Blue & Green label. In this ongoing everyday commitment to the planet, we never stop thinking about what we can do to help care for it.

Tierra, agua y fuego. Elementos imprescindibles para la fabricación de piezas cerámicas y la razón de nuestro compromiso con el planeta. Un compromiso adquirido desde nuestros inicios y que aplicamos en cada fase de nuestro negocio.

Un compromiso por el que creamos una auto declaración ambiental amparada bajo el sello Blue & Green.

Un compromiso por el que día a día seguimos preguntándonos qué podemos hacer.

Terre, eau et feu. Éléments indispensables pour la fabrication de pièces céramiques et la raison d'être de notre engagement envers la planète. Un engagement acquis dès nos débuts et que nous appliquons à chaque phase de notre commerce. Un engagement en vertu duquel nous créons une déclaration environnementale propre sous le label Blue & Green. Un engagement qui nous amène chaque jour à nous demander ce que nous pouvons faire de plus.

Land, Feuer und Wasser. Elemente, die für die Herstellung von Keramikfliesen unerlässlich sind, und den Grund für unsere Verpflichtung gegenüber der Umwelt darstellen. Eine Verpflichtung, die wir bereits von Anfang an eingegangen sind und die wir bei jeder unserer Betriebsphasen umsetzen. Aufgrund dieser Verpflichtung haben wir eine freiwillige Umwelterklärung gemäß dem Label Blue & Green ausgearbeitet. Diese Verpflichtung ist der Grund dafür, dass wir uns jeden Tag fragen, was wir noch tun können..

CERTIFICATES AND REGULATIONS

CERTIFICADOS Y NORMATIVAS | CERTIFICATS ET REGLEMENTATIONS | ZERTIFIKATE UND VORSCHRIFTEN



IMPROVED ENERGY EFFICIENCY INCREMENTAMOS NUESTRA EFICIENCIA ENERGÉTICA

We strive to ensure energy efficiency in all our techniques and processes. We also use the residual heat from our kilns in other processes so as to reduce the environmental impact we make and boost our energy efficiency. Our cogeneration plant also allows us to keep energy consumption and atmospheric CO2 emissions to a minimum.

Con ese objetivo impulsamos la eficiencia energética en todas nuestras técnicas y procesos. Al mismo tiempo aprovechamos el calor residual de nuestros hornos para convertirlo en electricidad. Este proceso de Cogeneración nos permite minimizar el consumo energético y las emisiones de CO2 a la atmósfera.

Cet objectif nous permet de favoriser l'efficacité énergétique dans toutes nos techniques et processus. Nous mettons également à profit la chaleur résiduelle de nos fours pour réduire notre impact sur l'environnement et accroître notre efficacité énergétique. Notre usine de Cogénération nous permet également de minimiser la consommation d'énergie et les émissions de CO2 dans l'atmosphère.

Mit diesem Ziel erhöhen wir die Energieeffizienz bei allen unseren Technologien und Verfahren. Gleichzeitig nutzen wir die Restwärme unserer Öfen, um unsere Umweltauswirkungen zu reduzieren und unsere Energieeffizienz zu verbessern. Außerdem können wir mit unserer Kraft-Wärme-Kopplungsanlage den Energieverbrauch und die CO2-Emissionen in die Luft auf ein Minimum reduzieren.

MINIMIZING OUR ENVIRONMENTAL IMPACT MINIMIZAMOS NUESTRO IMPACTO AMBIENTAL

We are managing to achieve this goal. Over the last five years, we have reduced our CO2 emissions by 20% while also increasing our input. This success has encouraged us to set new targets in the reduction of our carbon footprint.

Y estamos consiguiéndola. En los últimos cinco años hemos logrado reducir nuestras emisiones de CO2 en un 20%, al tiempo que hemos aumentado nuestra producción. Una gran noticia que nos impulsa a marcarnos nuevos objetivos para minimizar nuestra Huella de Carbono.

Et nous y parvenons. Au cours des cinq dernières années, nous avons réussi à réduire nos émissions de CO2 de 20%, tout en augmentant notre production. Une grande nouvelle qui nous amène à nous fixer de nouveaux objectifs pour minimiser notre Empreinte Carbone.

Wir sind dabei, es zu schaffen. In den vergangenen fünf Jahren konnten wir unsere CO2-Emissionen um 20 % senken und gleichzeitig unsere Produktion erhöhen. Eine hervorragende Nachricht, die uns dazu anspornt, uns neue Ziele zu setzen, um unseren Kohlenstoff-Fußabdruck auf ein Minimum zu reduzieren.

A CERTIFIED ENVIRONMENTAL PROCESS CERTIFICAMOS NUESTRO PROCESO AMBIENTAL

We have certified our Environmental Management System so as to ensure environmentally sustainable policies.

Por ello certificamos nuestra gestión ambiental para asegurar el desarrollo de nuestras políticas de sostenibilidad.

C'est la raison pour laquelle nous certifions notre gestion environnementale, pour garantir la réalisation de nos politiques de durabilité.

Deshalb zertifizieren wir unser Umweltmanagement, um die Abwicklung unserer Nachhaltigkeitsgrundsätze sicherzustellen.



RECYCLING AND RE-USING RECUPERAMOS Y REUTILIZAMOS

Thanks to water supplies from our own well and the re-use of all waste water from the manufacturing process, there is zero dumping of waste liquids. By re-using unfired waste and filtering dust particles, these waste clay materials and rejects can be re-used as raw materials. This allows us to minimize the consumption of clays and, by extension, the environmental impact that is made when they are quarried.

El autoconsumo de nuestro pozo y la reutilización de las aguas residuales del proceso de fabricación en su totalidad nos permiten afirmar que nuestro Vertido de Agua es igual a 0. La recuperación del fiesto crudo y la aspiración de las partículas de polvo nos permiten convertir en materia prima las mermas y desechos, recuperando arcillas y minimizando su consumo y así su impacto ambiental en minas.

L'autoconsommation de notre puits et la réutilisation de la totalité des eaux usées du processus de fabrication nous permettent d'affirmer que notre Rejet d'eau est égal à 0. La récupération du biscuit cru et l'aspiration des particules de poussières nous permettent de transformer les déchets et rejets de matériau en matière première, en récupérant les argiles et en minimisant leur consommation et donc leur impact sur l'environnement au sein des mines.

Durch die Nutzung unseres eigenen Brunnenwassers und die Wiederverwertung der gesamten Abwässer aus dem Produktionsprozess können wir guten Gewissens behaupten, dass unsere Abwassererzeugung gleich 0 ist. Durch die Rückgewinnung des Rohscherben und das Absaugen der Staubpartikel können wir das Ausschussmaterial und die Abfälle in Rohstoffe zurückverwandeln und damit Tone wiederverwerten, sodass der Tonverbrauch und dementsprechend der Umwelteinfluss der Minen reduziert wird.

WASTE MANAGEMENT GESTIONAMOS LOS RESIDUOS

With our Waste Management System, waste is sorted before it is given to authorized waste disposal companies.

Mediante nuestro sistema de gestión de residuos los segregamos de forma selectiva antes de entregárselos a los gestores autorizados.

Notre système de gestion des déchets nous permet de procéder à un tri sélectif avant de les remettre aux sociétés de gestion agréées.

Mit unserem Abfallmanagement werden die Reststoffe sorgfältig voneinander getrennt, bevor sie an zugelassene Entsorgungseinrichtungen übergeben werden.

FULLY RECYCLABLE PACKAGING TRABAJAMOS CON PACKAGING 100% RECICLABLE

Because what is truly important is what it contains. Our packaging is made of fully recyclable biodegradable cardboard.

Parque lo importante está en el interior. Nuestro packaging está fabricado con cartón 100% reciclable y biodegradable.

Car l'important est ce qui se trouve à l'intérieur. Notre packaging est fabriqué avec du carton 100% recyclable et biodégradable.

Denn das Wichtigste ist der Inhalt. Unsere Verpackungen sind zu 100 % aus recycelbarem und biologisch abbaubarem Karton.





TECHNICAL DETAILS

DATOS TÉCNICOS | PROPRIETÀS | CARATTERISTICHE | TECHNISCHE DATEN

WALL TILES REVESTIMIENTO

NORM NORMA	ISO 10545-3	UNEEN -101	ISO 10545-13	ISO 10545-14	ISO 10545-13	ISO 10545-13	ISO 10545-2
STANDARD VALUE VALOR	3% < E ≤ 6%	MOHS	Max. GA	Max. 5	Max. GHA	Max. GLA	± 5%

PORCELAIN TILES PORCELÁNICO

NORM NORMA	ISO 10545-12	UNEEN -101	ISO 10545-13	ISO 10545-14	ISO 10545-13	ISO 10545-13	ISO 10545-2
STANDARD VALUE VALOR	REQUIRED EXIGIDA	MOHS	Max. GA/UA	Max. 5	Max. GHA/UHA	Max. GLA/ULA	REQUIRED EXIGIDA

ALPINO	Pavimento / Floor Tiles	100 X 50 Base	<=0,5%	Resiste / Resist	8	UA	5	UHA	ULA	10,30 ± 0,50 mm
		30 X 30 Mosaico	<=0,5%	Resiste / Resist	8	UA	5	UHA	ULA	10,00 ± 0,50 mm
		30 X 60 Base	<=0,5%	Resiste / Resist	8	UA	5	UHA	ULA	9,60 ± 0,48 mm
		60 X 60 Base	<=0,5%	Resiste / Resist	8	UA	5	UHA	ULA	9,60 ± 0,48 mm
ARABESCATO	Pavimento / Floor Tiles	60 X 60 Base	0,5% < E <= 3%	No Aplica	5	GA	5	GHA	GLA	9,80 ± 0,49 mm
ARDENNES	Pavimento / Floor Tiles	100 X 24,8 Base	<=0,5%	Resiste / Resist	5	UA	5	UHA	ULA	10,30 ± 0,50 mm
		100 X 24,8 Base Antislip/Base Outdoor	<=0,5%	Resiste / Resist	7	UA	5	UHA	ULA	10,30 ± 0,50 mm
ATELIER	Revestimiento / Wall Tiles	25 X 25 Decorado	>10%	No Aplica	No aplica	GA	5	GHA	GLA	11,00 ± 0,50 mm
		25 X 70 Base	>10%	No Aplica	No aplica	GA	5	GHA	GLA	10,70 ± 0,50 mm
BEAUVAL	Pavimento / Floor Tiles	100 X 50 Base	<=0,5%	Resiste / Resist	6	UA	5	UHA	ULA	10,30 ± 0,50 mm
		30 X 30 Mosaico	<=0,5%	Resiste / Resist	5	UA	5	UHA	ULA	10,00 ± 0,50 mm
		30 X 60 Base	<=0,5%	Resiste / Resist	6	UA	5	UHA	ULA	9,60 ± 0,48 mm
		30 X 60 Base Antislip/Base Outdoor	<=0,5%	Resiste / Resist	8	UA	5	UHA	ULA	9,60 ± 0,48 mm
		30 X 60 Base Lappado/Base Soft	<=0,5%	Resiste / Resist	5	UA	5	UHA	ULA	9,60 ± 0,48 mm
		30 X 64 Muro	<=0,5%	Resiste / Resist	5	UA	5	UHA	ULA	10,00 ± 0,50 mm
		60 X 60 Base	<=0,5%	Resiste / Resist	6	UA	5	UHA	ULA	9,60 ± 0,48 mm
		60 X 60 Base Antislip/Base Outdoor	<=0,5%	Resiste / Resist	8	UA	5	UHA	ULA	9,60 ± 0,48 mm
		60 X 60 Base Lappado/Base Soft	<=0,5%	Resiste / Resist	5	UA	5	UHA	ULA	9,60 ± 0,48 mm
		25 X 70 Base	>10%	No Aplica	No aplica	GA	5	GHA	GLA	10,70 ± 0,50 mm
BETON	Revestimiento / Wall Tiles	25 X 50 Base	>10%	No Aplica	No aplica	GA	5	GHA	GLA	9,60 ± 0,50 mm
		25 X 50 Decorado	>10%	No Aplica	No aplica	GA	5	GHA	GLA	9,60 ± 0,50 mm
BLANCOS	Revestimiento / Wall Tiles	24 X 69 Base	>10%	No Aplica	No aplica	GA	5	GHA	GLA	10,70 ± 0,50 mm
		25 X 50 Base	>10%	No Aplica	No aplica	GA	5	GHA	GLA	9,60 ± 0,50 mm
		25 X 70 Base	>10%	No Aplica	No aplica	GA	5	GHA	GLA	10,70 ± 0,50 mm
BRANCATO	Pavimento / Floor Tiles	100 X 50 Base	<=0,5%	Resiste / Resist	6	UA	5	UHA	ULA	10,30 ± 0,50 mm
		18 X 73 Base Honed	<=0,5%	Resiste / Resist	5	GA	3	GHA	GLA	9,80 ± 0,49 mm
		30 X 30 Mosaico	<=0,5%	Resiste / Resist	5	UA	5	UHA	ULA	10,00 ± 0,50 mm
		30 X 60 Base	<=0,5%	Resiste / Resist	6	UA	5	UHA	ULA	9,60 ± 0,48 mm
		30 X 60 Base Antislip/Base Outdoor	<=0,5%	Resiste / Resist	8	UA	5	UHA	ULA	9,60 ± 0,48 mm
		30 X 60 Base Lappado/Base Soft	<=0,5%	Resiste / Resist	5	UA	5	UHA	ULA	9,60 ± 0,48 mm
		30 X 64 Muro	<=0,5%	Resiste / Resist	5	UA	5	UHA	ULA	10,00 ± 0,50 mm
		36 X 73 Base Honed	<=0,5%	Resiste / Resist	5	GA	3	GHA	GLA	9,80 ± 0,49 mm
		37 X 75 Base	<=0,5%	Resiste / Resist	6	UA	5	UHA	ULA	9,80 ± 0,49 mm
		37 X 75 Base Antislip/Base Outdoor	<=0,5%	Resiste / Resist	8	UA	5	UHA	ULA	9,80 ± 0,49 mm
		50 X 50 Base	<=0,5%	Resiste / Resist	5	GA	5	GHA	GLA	8,6 ± 0,50 mm
		60 X 60 Base	<=0,5%	Resiste / Resist	6	UA	5	UHA	ULA	9,60 ± 0,48 mm
		60 X 60 Base 20MM	<=0,5%	Resiste / Resist	7	UA	5	UHA	ULA	20,00 ± 0,50 mm
		60 X 60 Base Antislip/Base Outdoor	<=0,5%	Resiste / Resist	8	UA	5	UHA	ULA	9,60 ± 0,48 mm
		60 X 60 Base Lappado/Base Soft	<=0,5%	Resiste / Resist	5	UA	5	UHA	ULA	9,60 ± 0,48 mm
73 X 73 Base Honed	<=0,5%	Resiste / Resist	5	GA	3	GHA	GLA	9,80 ± 0,49 mm		
75 X 75 Base	<=0,5%	Resiste / Resist	6	UA	5	UHA	ULA	9,80 ± 0,49 mm		
75 X 75 Base 20MM	<=0,5%	Resiste / Resist	8	UA	5	UHA	ULA	20,00 ± 0,50 mm		
75 X 75 Base Antislip/Base Outdoor	<=0,5%	Resiste / Resist	8	UA	5	UHA	ULA	9,80 ± 0,49 mm		
Revestimiento / Wall Tiles	25 X 50 Base	>10%	No Aplica	No aplica	GA	5	GHA	GLA	9,60 ± 0,50 mm	
	25 X 50 Base Concept	>10%	No Aplica	No aplica	GA	5	GHA	GLA	9,60 ± 0,50 mm	
	30 X 60 Base	>10%	No Aplica	No aplica	GA	5	GHA	GLA	10,30 ± 0,50 mm	
	30 X 60 Base Concept	>10%	No Aplica	No aplica	GA	5	GHA	GLA	10,30 ± 0,50 mm	
	30 X 90 Base	>10%	No Aplica	No aplica	GA	5	GHA	GLA	11,30 ± 0,50 mm	
	30 X 90 Base Art	>10%	No Aplica	No aplica	GA	5	GHA	GLA	11,30 ± 0,50 mm	
	30 X 90 Base Concept	>10%	No Aplica	No aplica	GA	5	GHA	GLA	11,30 ± 0,50 mm	
CHELSEA	Revestimiento / Wall Tiles	30 X 90 Base	>10%	No Aplica	No aplica	GA	5	GHA	GLA	11,30 ± 0,50 mm
		30 X 90 Decorado	>10%	No Aplica	No aplica	GA	5	GHA	GLA	11,30 ± 0,50 mm
	Pavimento / Floor Tiles	50 X 50 Base	<=0,5%	Resiste / Resist	5	GA	5	GHA	GLA	8,6 ± 0,50 mm
CHEVERNIE	Pavimento / Floor Tiles	33 X 33 Mosaico	<=0,5%	Resiste / Resist	5	GA	5	GHB	GLA	9,40 ± 0,47 mm
		25 X 50 Base	>10%	No Aplica	No aplica	GA	5	GHA	GLA	9,60 ± 0,50 mm
COLOUR ME	Revestimiento / Wall Tiles	25 X 50 Base	>10%	No Aplica	No aplica	GA	5	GHA	GLA	9,60 ± 0,50 mm

*Please check technical chart / Consultar ficha técnica



MOOD	Revestimiento / Wall Tiles	75 X 75 Base Antislip/Base Outdoor	<=0,5%	Resiste / Resist	7	UA	5	UHB	ULA	9,80 ± 0,49 mm		
		30 X 90 Base	>10%	No Aplica	No aplica	GA	5	GHA	GLA	11,30 ± 0,50 mm		
		30 X 90 Base Art	>10%	No Aplica	No aplica	GA	5	GHA	GLA	11,30 ± 0,50 mm		
		30 X 90 Base Concept	>10%	No Aplica	No aplica	GA	5	GHA	GLA	11,30 ± 0,50 mm		
NATURE	Pavimento / Floor Tiles	100 X 50 Base	<=0,5%	Resiste / Resist	7	UA	5	UHA	ULA	10,30 ± 0,50 mm		
		100 X 50 Base Antislip/Base Outdoor	<=0,5%	Resiste / Resist	8	GA	5	GHA	GLA	10,30 ± 0,50 mm		
PALATINO	Pavimento / Floor Tiles	26 X 58 Muro	<=0,5%	Resiste / Resist	5	UA	5	UHA	ULA	10,00 ± 0,50 mm		
		30 X 30 Mosaico	<=0,5%	Resiste / Resist	5	UA	5	UHA	ULA	10,00 ± 0,50 mm		
		37 X 75 Base	<=0,5%	Resiste / Resist	7	UA	5	UHA	ULA	9,80 ± 0,49 mm		
		37 X 75 Base Antislip/Base Outdoor	<=0,5%	Resiste / Resist	8	UA	5	UHA	ULA	9,80 ± 0,49 mm		
		60 X 60 Base	<=0,5%	Resiste / Resist	7	UA	5	UHA	ULA	9,60 ± 0,48 mm		
		60 X 60 Base 20MM	<=0,5%	Resiste / Resist	5	UA	5	UHA	ULA	20,00 ± 0,50 mm		
		75 X 75 Base	<=0,5%	Resiste / Resist	7	UA	5	UHA	ULA	9,80 ± 0,49 mm		
		75 X 75 Base 20MM	<=0,5%	Resiste / Resist	5	UA	5	UHA	ULA	20,00 ± 0,50 mm		
		75 X 75 Base Antislip/Base Outdoor	<=0,5%	Resiste / Resist	8	UA	5	UHA	ULA	9,80 ± 0,49 mm		
		30 X 90 Base	>10%	No Aplica	No aplica	GA	5	GHA	GLA	11,30 ± 0,50 mm		
		30 X 90 Base Concept	>10%	No Aplica	No aplica	GA	5	GHA	GLA	11,30 ± 0,50 mm		
		PETIT GRANIT	Pavimento / Floor Tiles	18 X 73	<=0,5%	Resiste / Resist	5	GA	3	GHA	GLA	9,80 ± 0,49 mm
				26 X 58 Muro	<=0,5%	Resiste / Resist	5	GA	5	GHA	GLA	10,20 ± 0,50 mm
				30 X 30 Mosaico	<=0,5%	Resiste / Resist	5	GA	5	GHA	GLA	10,20 ± 0,50 mm
36 X 73 Base Honed	<=0,5%			Resiste / Resist	5	GA	3	GHA	GLA	9,80 ± 0,49 mm		
73 X 73 Base Honed	<=0,5%			Resiste / Resist	5	GA	3	GHA	GLA	9,80 ± 0,49 mm		
PORTOBELLO	Pavimento / Floor Tiles	100 X 24,8 Base	<=0,5%	Resiste / Resist	6	UA	5	UHA	ULA	10,30 ± 0,50 mm		
		100 X 24,8 Base Antislip/Base Outdoor	<=0,5%	Resiste / Resist	8	UA	5	UHA	ULA	10,30 ± 0,50 mm		
		18,5 X 75 Base	<=0,5%	Resiste / Resist	6	GA	5	GHA	GLA	9,80 ± 0,49 mm		
		18,5 X 75 Base Antislip/Base Outdoor	<=0,5%	Resiste / Resist	8	GA	5	GHA	GLA	9,80 ± 0,49 mm		
PRIORAT	Pavimento / Floor Tiles	22,8 X 39 Muro	<=0,5%	Resiste / Resist	5	UA	5	UHA	ULA	10,00 ± 0,50 mm		
		30 X 30 Mosaico	<=0,5%	Resiste / Resist	5	UA	5	UHA	ULA	10,00 ± 0,50 mm		
		30 X 60 Base	<=0,5%	Resiste / Resist	5	UA	5	UHA	ULA	9,60 ± 0,48 mm		
		30 X 60 Base Antislip/Base Outdoor	<=0,5%	Resiste / Resist	5	UA	5	UHA	ULA	9,60 ± 0,48 mm		
		60 X 60 Base	<=0,5%	Resiste / Resist	5	UA	5	UHA	ULA	9,60 ± 0,48 mm		
		60 X 60 Base Antislip/Base Outdoor	<=0,5%	Resiste / Resist	5	UA	5	UHA	ULA	9,60 ± 0,48 mm		
		60 X 60 Base Modul	<=0,5%	Resiste / Resist	5	UA	5	UHA	ULA	9,60 ± 0,48 mm		
		25 X 70 Base	>10%	No Aplica	No aplica	GA	5	GHA	GLA	10,70 ± 0,50 mm		
		25 X 70 Base Concept	>10%	No Aplica	No aplica	GA	5	GHA	GLA	10,70 ± 0,50 mm		
		REMAKE	Pavimento / Floor Tiles	30 X 30 Mosaico	<=0,5%	Resiste / Resist	5	UA	5	UHA	ULA	10,00 ± 0,50 mm
30 X 60 Base	<=0,5%			Resiste / Resist	5	UA	5	UHA	ULA	9,60 ± 0,48 mm		
60 X 60 Base	<=0,5%			Resiste / Resist	5	UA	5	UHA	ULA	9,60 ± 0,48 mm		
60 X 60 Base Modul	<=0,5%			Resiste / Resist	5	UA	5	UHA	ULA	9,60 ± 0,48 mm		
25 X 70 Base	>10%			No Aplica	No aplica	GA	5	GHA	GLA	10,70 ± 0,50 mm		
25 X 70 Base Concept	>10%			No Aplica	No aplica	GA	5	GHA	GLA	10,70 ± 0,50 mm		
SAVIA	Pavimento / Floor Tiles	150 X 24,8 Base	<=0,5%	Resiste / Resist	5	UA	5	UHA	ULA	10,70 ± 0,50 mm		
		150 X 24,8 Base Antislip/Base Outdoor	<=0,5%	Resiste / Resist	7	UA	5	UHA	ULA	10,70 ± 0,50 mm		
		18,5 X 75 Base	<=0,5%	Resiste / Resist	5	UA	5	UHA	ULA	9,80 ± 0,49 mm		
		18,5 X 75 Base Antislip/Base Outdoor	<=0,5%	Resiste / Resist	7	UA	5	UHA	ULA	9,80 ± 0,49 mm		
SOHO	Revestimiento / Wall Tiles	25 X 70 Base	>10%	No Aplica	No aplica	GA	5	GHA	GLA	10,70 ± 0,50 mm		
		25 X 70 Base Tesela/Base Split	>10%	No Aplica	No aplica	GA	5	GHA	GLA	10,70 ± 0,50 mm		
		25 X 70 Decorado	>10%	No Aplica	No aplica	GA	5	GHA	GLA	10,70 ± 0,50 mm		
STONETECH	Pavimento / Floor Tiles	50 X 50 Base	<=0,5%	Resiste / Resist	5	GA	5	GHA	GLA	8,6 ± 0,50 mm		
		30 X 60 Base	<=0,5%	Resiste / Resist	5	UA	5	UHA	ULA	9,60 ± 0,48 mm		
		60 X 60 Base	<=0,5%	Resiste / Resist	5	UA	5	UHA	ULA	9,60 ± 0,48 mm		
		60 X 60 Base 20MM	<=0,5%	Resiste / Resist	5	UA	5	UHA	ULA	20,00 ± 0,50 mm		

*Please check technical chart / Consultar ficha técnica



TERMAE	Pavimento / Floor Tiles	75 X 75 Base	<=0,5%	Resiste / Resist	7	UA	5	UHA	ULA	10,20 ± 0,50 mm
		75 X 75 Base 20MM	<=0,5%	Resiste / Resist	5	UA	5	UHA	ULA	20,00 ± 0,50 mm
		75 X 75 Base Lappada/Base Soft	<=0,5%	Resiste / Resist	5	UA	5	UHB	ULA	9,80 ± 0,49 mm
		33 X 33 Mosaico	<=0,5%	Resiste / Resist	5	GA	5	GHA	GLA	9,00 ± 0,45 mm
THAI	Revestimiento / Wall Tiles	50 X 50 Base	<=0,5%	Resiste / Resist	5	GA	5	GHA	GLA	8,6 ± 0,50 mm
		25 X 50 Base	>10%	No Aplica	No aplica	GA	5	GHA	GLA	9,60 ± 0,50 mm
UPTOWN	Pavimento / Floor Tiles	25 X 50 Base Concept	>10%	No Aplica	No aplica	GA	5	GHA	GLA	9,60 ± 0,50 mm
		150 X 37 Base	<=0,5%	Resiste / Resist	5	UA	5	UHA	ULA	10,70 ± 0,50 mm
		150 X 37 Base Concept	<=0,5%	Resiste / Resist	5	UA	5	UHA	ULA	10,70 ± 0,50 mm
		150 X 75 Base	<=0,5%	Resiste / Resist	5	UA	5	UHA	ULA	10,70 ± 0,50 mm
		30 X 30 Mosaico	<=0,5%	Resiste / Resist	5	UA	5	UHA	ULA	10,20 ± 0,50 mm
		37 X 75 Base	<=0,5%	Resiste / Resist	5	UA	5	UHA	ULA	9,80 ± 0,49 mm
		37 X 75 Base Antislip/Base Outdoor	<=0,5%	Resiste / Resist	5	UA	5	UHA	ULA	9,80 ± 0,49 mm
		50 X 50 Base	<=0,5%	Resiste / Resist	5	GA	5	GHA	GLA	8,6 ± 0,50 mm
		60 X 60 Base	<=0,5%	Resiste / Resist	5	UA	5	UHA	ULA	9,60 ± 0,48 mm
		60 X 60 Base 20MM	<=0,5%	Resiste / Resist	7	UA	5	UHA	ULA	20,00 ± 0,50 mm
		75 X 75 Base	<=0,5%	Resiste / Resist	5	UA	5	UHA	ULA	9,80 ± 0,49 mm
		75 X 75 Base 20MM	<=0,5%	Resiste / Resist	5	UA	5	UHA	ULA	20,00 ± 0,50 mm
		75 X 75 Base Antislip/Base Outdoor	<=0,5%	Resiste / Resist	7	UA	5	UHA	ULA	9,80 ± 0,49 mm
		75 X 75 Base Modul	<=0,5%	Resiste / Resist	5	UA	5	UHA	ULA	9,80 ± 0,49 mm
URBAN	Pavimento / Floor Tiles	25 X 50 Base	>10%	No Aplica	No aplica	GA	5	GHA	GLA	9,60 ± 0,50 mm
		25 X 50 Base Concept	>10%	No Aplica	No aplica	GA	5	GHA	GLA	9,60 ± 0,50 mm
		30 X 90 Base	>10%	No Aplica	No aplica	GA	5	GHA	GLA	11,30 ± 0,50 mm
		30 X 90 Base Art	>10%	No Aplica	No aplica	GA	5	GHA	GLA	11,30 ± 0,50 mm
		30 X 90 Base Concept	>10%	No Aplica	No aplica	GA	5	GHA	GLA	11,30 ± 0,50 mm
		100 X 50 Base	<=0,5%	Resiste / Resist	8	UA	5	UHA	ULA	10,30 ± 0,50 mm
VELVET	Revestimiento / Wall Tiles	30 X 30 Malla	>10%	No Aplica	No aplica	GA	5	GHA	GLA	10,70 ± 0,50 mm
		30 X 90 Base	>10%	No Aplica	No aplica	GA	5	GHA	GLA	11,30 ± 0,50 mm
		30 X 90 Base Modul	>10%	No Aplica	No aplica	GA	5	GHA	GLA	11,30 ± 0,50 mm
		30 X 90 Decorado	>10%	No Aplica	No aplica	GA	5	GHA	GLA	11,30 ± 0,50 mm
		60 X 60 Base	<=0,5%	Resiste / Resist	8	UA	5	UHA	ULA	9,60 ± 0,48 mm
		60 X 60 Base Antislip/Base Outdoor	<=0,5%	Resiste / Resist	9	UA	5	UHA	ULA	9,60 ± 0,48 mm
VILLAGE	Pavimento / Floor Tiles	100 X 24,8 Base	<=0,5%	Resiste / Resist	5	UA	5	UHA	ULA	10,30 ± 0,50 mm
		18,5 X 75 Base	<=0,5%	Resiste / Resist	5	UA	5	UHA	ULA	9,80 ± 0,49 mm
WALL BRICK	Revestimiento / Wall Tiles	30 X 90 Base Concept	>10%	No Aplica	No aplica	GA	5	GHA	GLA	11,30 ± 0,50 mm
ZEBRA	Pavimento / Floor Tiles	100 X 50 Base	<=0,5%	Resiste / Resist	5	GA	5	GHA	GLA	10,30 ± 0,50 mm

*Please check technical chart / Consultar ficha técnica

PACKING LIST

EMBALAJE | EMBALLAGE | VERPACKUNG

Item Artículo	Size Formato	pcs-box pzs-cj	m2/box m2/cj	kg/box kg/cj	box/epl cj/epl	m2/epl	kg/epl
ALPINO	100x50/40"x20" Base	2	1.00	23.60	28	28.00	683.80
	60x60/24"x24" Base	3	1.08	22.53	40	43.20	924.20
	30x60/12"x24" Base	6	1.08	22.32	40	43.20	915.80
	30x30/12"x12" Mosaico	11	1.00	20.46	36	36.00	759.56
	8x60/3"x24" Rodapié	10	0.48	11.50	80	38.40	943.00
	30x60/12"x24" Peldaño	6	1.08	20.58		Please ask for information / Consulte información	
	30x60/12"x24" Peldaño Doble	2	0.36	13.28		Please ask for information / Consulte información	
	100x50/40"x20" Peldaño	2	1.00	25.20		Please ask for information / Consulte información	
	100x50/40"x20" Peldaño Doble	2	1.00	28.34		Please ask for information / Consulte información	
	ARABESCATTO	60x60/24"x24" Base	3	1.08	22.53	40	43.20
ARDENNES	100x24,8/40"x10" Base/ Antislip	3	0.74	17.67	40	29.60	729.80
	8x50/3"x20" Rodapié	10	0.40	9.60	120	48	1175
	100x24,8/40"x10" Peldaño Base / Antislip	3	0.74	22.50		Please ask for information / Consulte información	
ATELIER	100x24,8/40"x10" Peldaño Doble Base / Antislip	2	0.50	12.60		Please ask for information / Consulte información	
	25x70/10"x28" Base	7	1.23	21.35	42	51.66	919.70
BEAUVAL	25x25/10"x10" Decor	4	0.25	5.48	66	16.50	384.68
	4,6x70/1,8"x28" Listelo	4	0.13	2.52	144	18.55	385.88
	100x50/40"x20" Base	2	1.00	23.60	28	28.00	683.80
	60x60/24"x24" Base/ Lappato / Antislip	3	1.08	22.53	40	43.20	924.20
	30x60/12"x24" Base/ Lappato / Antislip	6	1.08	22.32	40	43.20	915.80
	25x70/10"x28" Base / Concept	7	1.23	21.35	42	51.66	919.70
	30x64/11,8"x25" Muro	5	0.96	18.45	30	28.80	576.50
	30x30/12"x12" Mosaico	11	1.00	20.46	36	36.00	759.56
	5x36/2"x14" Listelo	10	0.18	3.60	72	12.96	282.20
	8x60/3"x24" Rodapié Base / Lappato	10	0.48	11.30	80	38.40	943.00
BETON	30x60/12"x24" Peldaño Base / Lappato / Antislip	6	1.08	20.58		Please ask for information / Consulte información	
	30x60/12"x24" Peldaño Doble Base / Lappato / Antislip	2	0.36	13.28		Please ask for information / Consulte información	
	100x50/40"x20" Peldaño	2	1.00	25.20		Please ask for information / Consulte información	
	100x50/40"x20" Peldaño Doble	2	1.00	28.34		Please ask for information / Consulte información	
	25x50/10"x20" Base	11	1.38	21.78	36	49.68	807.08
	25x50/10"x20" Decor	8	1.00	16.00	45	45	743
	3,8x50/1,5"x20 Listelo	22	0.42	7.48	90	37.62	696.20
	25x70/10"x28" Base	7	1.23	21.35	42	51.66	919.70
	24x69/9"x27" Base	7	1.16	19.53	42	48.72	843.00
	25x50/10"x20" Base	11	1.38	21.78	36	49.68	807.08
BLANCOS	1,5x50/0,8"x20" Perfil	6	0.05	0.48	400	18.00	215.00
	1,5x70/0,8"x28" Perfil	6	0.06	0.72	400	25.20	311.00
	73x73/28"x28 Base	2	1.07	23.96	42	44.94	1.029.32
	36x73/14"x28" Base	4	1.07	23.60	48	51.36	1.155.80
	18x73/7"x28" Base	9	1.19	25.20	48	57.12	1.232.60
	100x50/40"x20" Base / Lappato	2	1.00	23.60	28	28.00	683.80
	75x75/30"x30" Base / Antislip	2	1.13	24.62	42	47.46	1.057.04
	75x75/30"x30" 20 MM	1	0.56	24.91	42	23.52	1.069.22
	60x60/24"x24" Base / Lappato / Antislip	3	1.08	22.53	40	43.20	924.20
	60x60/24"x24" 20 MM	2	0.72	31.72	32	23.04	1.038.04
BRANCATO	30x60/12"x24" Base / Lappato / Antislip	6	1.08	22.32	40	43.20	915.80
	37x75/15"x30" Base / Antislip	4	1.13	24.24	48	54.24	1.186.52
	30x90/12"x36" Base / Concept / Art	4	1.08	18.84	51	55.08	983.84
	30x60/12"x24" Base / Concept	6	1.08	18.48	40	43.20	762.20
	25x50/10"x20" Base / Concept	11	1.38	21.78	36	49.68	807.08
	50x50/20"x20" Base	4	1.00	20.52	36	36.00	761.72
	4x50/1,6"x20" Listelo	22	0.44	6.82	84	36.96	596.88
	4,5x90/1,5"x20"	6	0.24	4.50	56	13.61	275.00
	8x50/3"x20" Rodapié	10	0.40	9.60	120	48.00	1.175.00
	1,5x90/1,8"x36" Perfil	6	0.08	0.90	336	27.22	325.40
FRAME	1,5x60/1,8"x24" Perfil	6	0.05	0.54	500	27.00	293.00
	30x64/11,8"x25" Muro	5	0.96	18.45	30	28.80	576.50
	30x30/12"x12" Mosaico	11	1.00	20.46	36	36.00	759.56
	26x26/10"x10" Tetris	11	0.74	15.40	36	26.64	577.40
	8x60/3"x24" Rodapié Base / Lappato	10	0.48	11.30	80	38.40	943.00
	8x75/3"x30" Rodapié	10	0.60	12.90	80	48.00	1.055.00
	30x60/12"x24" Peldaño Base / Lappato / Antislip	6	1.08	20.58		Please ask for information / Consulte información	
	37x75/15"x30" Peldaño Base / Antislip	4	1.11	24.24		Please ask for information / Consulte información	
	100x50/40"x20" Peldaño	2	1.00	25.20		Please ask for information / Consulte información	
	30x60/12"x24" Peldaño Doble Base / Lappato / Antislip	2	0.36	13.28		Please ask for information / Consulte información	
ITEM	37x75/15"x30" Peldaño Doble Base / Antislip	2	0.56	12.12		Please ask for information / Consulte información	
	100x50/40"x20" Peldaño Doble	2	1.00	28.34		Please ask for information / Consulte información	
	8x73/3"x28" Rodapié	10	0.60	12.90	80	48.00	1.055.00

Item Artículo	Size Formato	pcs-box pzs-cj	m2/box m2/cj	kg/box kg/cj	box/epl cj/epl	m2/epl	kg/epl
CHELSEA	30x90/12"x36" Base	4	1.08	18.84	51	55.08	983.84
	30x90/12"x36" Decor	4	1.08	21.72	12	12.96	283.64
	6,9x90/2,7"x35,4" Listelo	6	0.37	7.50	54	20.12	428.00
	2x90/0,8"x35,4" Perfil Metálico	6	0.11	3.00	200	21.60	623.00
CHEVERNIE	25x50/10"x20" Base	11	1.38	21.78	36	49.68	807.08
	8x25/3"x10" Base	22	0.45	8.80	120	54.00	1.079.00
	5x25/2"x10" Bullnose	22	0.28	3.52	150	41.25	551.00
	33x33/13"x13" Mosaico	10	1.09	19.00	36	39.24	707.00
	50x50/20"x20" Base	4	1.00	20.52	36	36.00	761.72
	33x33/13"x13" Base	11	1.21	22.55	48	58.08	1.105.4
COLOUR ME	5,8x25/2,3"x10" Listelo	19	0.28	5.13	120	33.06	638.60
	25x50/10"x20" Base / Concept	11	1.38	21.78	36	49.68	807.08
DIADEME	3,8x50/1,5"x20" Listelo	20	0.38	6.40	120	45.60	791.00
	25x70/10"x28" Base / Concept	7	1.23	21.35	42	51.66	919.70
	25x70/10"x28" Decor	4	0.70	12.40	42	29.40	543.80
DISTRICT	4,6x70/1,8"x28" Listelo	6	0.19	3.90	144	27.82	584.60
	25x50/10"x20" Base / Concept	11	1.38	21.78	36	49.68	807.08
	4,6x50/1,8"x20" Listelo	10	0.23	3.60	120	27.60	455.00
ELVEN	50x50/20"x20" Base	4	1.00	20.52	36	36.00	761.72
	8x50/3"x20" Rodapié	10	0.40	9.60	120	48.00	1.175.00
	150x75/60"x30" Lappato	1	1.12	26.80	48	53.76	1.309.40
	150x37/60"x15" Lappato / Concept Lappato	2	1.12	26.80	50	56.00	1.363.00
EVOLUTION	8x75/3"x30" Rodapié Lappato	10	0.60	12.90	80	48.00	1.055.00
	150x37/60"x15" Peldaño Lappato	2	1.11	26.80		Please ask for information / Consulte información	
	150x37/60"x15" Peldaño Doble Lappato	2	1.11	26.80		Please ask for information / Consulte información	
	100x50/40"x20" Base	2	1.00	23.60	28	28.00	683.80
	75x75/30"x30" Base/ Lappato / Antislip	2	1.13	24.62	42	47.46	1.057.04
	37x75/15"x30" Base/ Lappato / Antislip	4	1.13	24.24	48	54.24	1.186.52
	60x60/24"x24" Base/Lappato	3	1.08	22.53	40	43.20	924.20
	25x70/9"x28" Base/Concept	7	1.23	21.35	42	51.66	919.70
	1,5x70/1,8"x28" Perfil	6	0.06	0.72	400	25.20	311.00
	30x30/12"x12" Mosaico	11	1.00	20.46	36	36.00	759.56
EVOQUE	8x50/3"x20" Rodapié Base	10	0.40	9.60	120	48.00	1.175.00
	8x60/3"x24" Rodapié Base/Lappato	10	0.48	11.30	80	38.40	943.00
	8x75/3"x30" Rodapié Base/Lappato	10	0.60	12.90	80	48.00	1.055.00
	30x60/12"x24" Peldaño Base/Lappato	6	1.08	20.58		Please ask for information / Consulte información	
	37x75/15"x30" Peldaño Base/Lappato/Antislip	4	1.11	24.24		Please ask for information / Consulte información	
	30x60/12"x24" Peldaño Doble Base/Lappato	2	0.36	13.28		Please ask for information / Consulte información	
	37x75/15"x30" Peldaño Doble Base/Lappato/Antislip	2	0.56	12.12		Please ask for information / Consulte información	
	100x50/40"x20" Peldaño Base	2	1.00	25.20		Please ask for information / Consulte información	
	100x50/40"x20" Peldaño Doble Base	2	1.00	28.34		Please ask for information / Consulte información	
	150x75/60"x30" Base	1	1.12	26.80	48	53.76	1.309.40
FRAME	150x37/60"x15" Base / Concept	2	1.12	26.80	50	56.00	1.363.00
	8x25 / 3"x10" Base	22	0.45	8.80	120	54.00	1.079.00
	30x90/12"x36" Base/Concept/Art	4	1.08	18.48	51	55.08	762.20
	30x90/12"x36" Decor	2	0.54	9.80	44	23.76	454.20
	30x60/12"x24" Base/Concept	6	1.08	18.48	40	43.20	762.20
	30x30/12"x12" Mosaico	11	1.00	20.46	36	36.00	759.56
	1,5x60/1,8"x24" Perfil	6	0.05	0.54	500	27.00	293.00
	4,5x90/1,5"x20" Listelo	6	0.24	4.92	56	13.61	298.52
	4,8x30/1,9"x12" Listelo	11	0.16	3.30	110	17.42	386.00
	7x30/2,7"x12" Listelo	11	0.23	4.95	90	20.79	468.50
ITEM	12,5x30/4,9"x12" Zócalo	6	0.22	4.80	110	24.75	551.00
	1,5x90/1,8"x36" Perfil	6	0.08	0.90	336	27.22	325.40
	75x75/30"x30" Gloss / Brillo Matt / Mate	2	1.13	24.62	42	47.46	1.057.04
	37x75/15"x30" Gloss / Brillo Matt / Mate	4	1.13	24.24	48	54.24	1.186.52
	60x60/24"x24" Gloss / Brillo Matt / Mate	3	1.08	22.53	40	43.20	924.20
	8x75/3"x30" Rodapié Gloss / Brillo Matt / Mate	10	0.60	12.90	80	48.00	1.055.00
	37x75/15"x30" Peldaño Gloss / Brillo Matt / Mate	4	1.11	24.24		Please ask for information / Consulte información	
	37x75/15"x30" Peldaño Doble Gloss / Brillo Matt / Mate	2	0.56	12.12		Please ask for information / Consulte información	
	75x75/30"x30" Base / Antislip	2	1.13	24.62	42	47.46	1.057.04
	37x75/15"x30" Base / Antislip	4	1.13	24.24	48	54.24	1.186.52
ITEM	60x60/24"x24" Base	3	1.08	22.53	40	43.20	924.20
	26x30/10"x12" Cube	11	0.85	15.40	36	30.60	577.40
	8x60/3"x24" Rodapié	10	0.48	11.30	80	38.40	943.00
	30x90/12"x36" Base / Concept / Art	4	1.08	18.84	51	55.08	983.84
	1,5x90/1,8"x36" Perfil	6	0.08	0.90	336	27.22	325.40
	8x75/3"x30" Rodapié	10	0.60	12.90	80	48.00	1.055.00
	30x60/12"x24" Peldaño	6	1.08	22.58		Please ask for information / Consulte información	
	30x60/12"x24" Peldaño Doble	2	0.36	13.28		Please ask for information / Consulte información	
	37x75/15"x30" Peldaño Base/Antislip	4	1.11	24.24		Please ask for information / Consulte información	
	37x75/15"x30" Peldaño Doble Base/Antislip	2	0.56	12.12		Please ask for information / Consulte información	

Item Artículo	Size Formato	pcs-box pzs-cj	m2/box m2/cj	kg/box kg/cj	box/epl cj/epl	m2/epl	kg/epl	
FRESH	25x70/10"x28" Base / Modul	7	1,23	21,35	42	51,66	919,70	
	25x70/10"x28" Decor	3	0,52	9,6	42	22,00	426,20	
	7,8x70/3"x28" Listelo	6	0,33	6,12	80	26,21	512,60	
	30x30/12"x12" Malla	9	0,81	12,60	42	34,00	552,00	
	100x50/40"x20" Base/Lappato	2	1,00	23,60	28	28,00	683,80	
	75x75/30"x30" Base/Lappato/Antislip	2	1,13	24,62	42	47,46	1057,04	
	37x75/15"x30" Base/Lappato/Antislip	4	1,13	24,24	48	54,24	1186,52	
	60x60/24"x24" Base/Lappato	3	1,08	22,53	40	43,20	924,20	
	30x90/12"x36" Base/Concept	4	1,08	18,84	51	55,08	983,84	
	30x90/12"x36" Decor	2	0,54	9,80	44	23,76	454,20	
FUTURE	1,5x90/0,8"x36" Perfil	6	0,08	0,90	336	27,22	325,40	
	26x58/10"x24" Muro	5	0,75	15,10	30	22,50	476,00	
	30x30/12"x12" Mosaico	11	1,00	20,46	36	36,00	759,56	
	25x70/10"x28" Base / Concept	7	1,23	21,35	42	51,66	919,70	
	50x50/20"x20" Base	4	1,00	20,52	36	36,00	761,72	
	1,5x70/0,8"x28" Perfil	6	0,06	0,72	400	25,20	311,00	
	30,5x32,5/14"x14" Malla	11	1,09	6,05	72	78,51	458,60	
	4,8x30/1,9"x12" Listelo	11	0,16	3,30	110	17,42	386,00	
	12,5x30/4,9"x12" Zócalo	6	0,22	4,80	110	24,75	551,00	
	8x50/3"x20" Rodapié	10	0,40	9,60	120	48	1175	
	8x60/3"x24" Rodapié Base/Lappato	10	0,48	11,30	80	38,40	943,00	
	8x75/3"x30" Rodapié Base/Lappato	10	0,60	12,90	80	48,00	1055,00	
	30x60/12"x24" Peldaño Base/Lappato	6	1,08	20,58		Please ask for information / Consulte información		
	37x75/15"x30" Peldaño Base/Lappato/Antislip	4	1,11	24,24		Please ask for information / Consulte información		
	100x50/40"x20" Peldaño Base/Lappato	2	1,00	25,20		Please ask for information / Consulte información		
	30x60/12"x24" Peldaño Doble Base/Lappato	2	0,36	13,28		Please ask for information / Consulte información		
	37x75/15"x30" Peldaño Doble Base/Lappato/Antislip	2	0,56	12,12		Please ask for information / Consulte información		
	100x50/40"x20" Peldaño Doble Base/Lappato	2	1,00	28,34		Please ask for information / Consulte información		
	JAZZ	60x60/24"x24" Base/ Outdoor	3	1,08	22,53	40	43,20	924,20
		30x60/12"x24" Base	6	1,08	22,32	40	43,20	915,80
30x30/12"x12" Mosaico		11	1,00	20,46	36	36,00	759,56	
8x60/3"x24" Rodapié		10	0,48	11,50	80	38,40	943,00	
30x60/12"x24" Peldaño		6	1,08	20,58		Please ask for information / Consulte información		
30x60/12"x24" Peldaño Doble		2	0,36	13,28		Please ask for information / Consulte información		
KURSAL		100x50/40"x20" Base	2	1,00	23,60	28	28,00	683,80
		60x60/24"x24" Base	3	1,08	22,53	40	43,20	924,20
		30x60/12"x24" Base	6	1,08	22,32	40	43,20	915,80
		25x50/10"x20" Base	11	1,38	21,78	36	49,68	807,08
	50x50/20"x20" Base	4	1,00	20,52	36	36,00	761,72	
	12x50/4,7"x20" Listelo	7	0,42	7,70	78	32,75	623,60	
	8x50/3"x20" Rodapié	10	0,40	9,60	120	48,00	1175,00	
	8x60/3"x24" Rodapié	10	0,48	11,50	80	38,40	943,00	
	30x60/12"x24" Peldaño	6	1,08	20,58		Please ask for information / Consulte información		
	30x60/12"x24" Peldaño Doble	2	0,36	13,28		Please ask for information / Consulte información		
LAVA	100x50/40"x20" Peldaño	2	1,00	25,20		Please ask for information / Consulte información		
	100x50/40"x20" Peldaño Doble	2	1,00	28,34		Please ask for information / Consulte información		
	100x50/40"x20" Base	2	1,00	23,60	28	28,00	683,80	
	60x60/24"x24" Base / Outdoor	3	1,08	22,53	40	43,20	924,20	
	30x60/12"x24" Base / Outdoor	6	1,08	22,32	40	43,20	915,80	
	30x30/12"x12" Mosaico	11	1,00	20,46	36	36,00	759,56	
	8x60/3"x24" Rodapié	10	0,48	11,30	80	38,40	943,00	
	30x60/12"x24" Peldaño Base / Outdoor	6	1,08	20,58		Please ask for information / Consulte información		
	30x60/12"x24" Peldaño Doble Base / Outdoor	2	0,36	13,28		Please ask for information / Consulte información		
	100x50/40"x20" Peldaño	2	1,00	25,20		Please ask for information / Consulte información		
LIVING	100x50/40"x20" Peldaño Doble	2	1,00	28,34		Please ask for information / Consulte información		
	75x75/30"x30" Base / Lappato	2	1,13	24,62	42	47,46	1057,04	
	37x75/15"x30" Base / Lappato	4	1,13	24,24	48	54,24	1186,52	
	60x60/24"x24" Base / Lappato	3	1,08	22,53	40	43,20	924,20	
	25x70/10"x28" Base / Líneas	7	1,23	21,35	42	51,66	919,70	
	50x50/20"x20" Base	4	1,00	20,52	36	36,00	761,72	
	7,8x70/3"x28" Listelo	4	0,22	4,32	80	17,47	368,60	
	8x50/3"x20" Rodapié	10	0,40	9,60	120	48,00	1175,00	
	30x30/12"x12" Mosaico	11	1,00	20,46	36	36,00	759,56	
	8x60/3"x24" Rodapié Base / Lappato	10	0,48	11,30	80	38,40	943,00	
LOUNGE	8x75/3"x30" Rodapié Base / Lappato	10	0,60	12,90	80	48,00	1055,00	
	25x70/10"x28" Base / Concept	7	1,23	21,35	42	51,66	919,70	
	30x30/12"x12" Malla	9	0,81	15,57	42	34,00	676,94	
	7,8x70/3"x28" Listelo	6	0,33	6,48	80	26,21	541,40	

Item Artículo	Size Formato	pcs-box pzs-cj	m2/box m2/cj	kg/box kg/cj	box/epl cj/epl	m2/epl	kg/epl	
MADAGASCAR	75x75/30"x30" Base	2	1,13	24,62	42	47,46	1057,04	
	37x75/15"x30" Base	4	1,13	24,24	48	54,24	1186,52	
	26x58/10"x24" Muro	5	0,75	15,10	30	22,50	476,00	
	30x30/12"x12" Mosaico	11	1,00	20,46	36	36,00	759,56	
	8x75/3"x30" Rodapié	10	0,60	12,90	80	48,00	1055,00	
	37x75/15"x30" Peldaño	4	1,11	24,24		Please ask for information / Consulte información		
	37x75/15"x30" Peldaño Doble	2	0,56	12,12		Please ask for information / Consulte información		
	100x24,8/40"x10" Base / Lappato / C-3	3	0,74	17,67	40	29,60	729,80	
	30x90/12"x36" Base / Concept	4	1,08	18,84	51	55,08	983,84	
	1,5x90/0,8"x36" Perfil Acero	6	0,08	0,90	336	27,22	325,40	
MADEIRA	8x50/3"x20" Rodapié Natural / Lappato	10	0,40	9,60	120	48,00	1175,00	
	100x24,8/40"x10" Peldaño Natural / Lappato / C-3	3	0,74	22,50		Please ask for information / Consulte información		
	100x24,8/40"x10" Peldaño Doble Natural / Lappato / C-3	2	0,50	12,60		Please ask for information / Consulte información		
	50x50/20"x20" Base	4	1,00	20,52	36	36,00	761,72	
	8x50/3"x20" Rodapié	10	0,40	9,60	120	48	1175	
MILLENIUM	30x90/12"x36" Base / Rubik / Quilt / Flow	4	1,08	18,84	51	55,08	983,84	
MISTERY	30x90/12"x36" Base	4	1,08	18,84	51	55,08	983,84	
	30x90/12"x36" Decor	4	1,08	21,72	12	12,96	283,64	
	8,5x30/3,3"x12" listelo Boboli	10	0,25	1,70	70	17,85	142,00	
	8,5x30/3,3"x12" listelo Boboli Flow	12	0,30	2,04	65	19,89	155,60	
	12x30/4,7"x12" Zócalo	14	0,50	13,44	65	32,76	896,60	
	2x90/0,8"x35,4" Perfil Metallic	6	0,11	3,00	200	21,60	623,00	
	MISTRAL	25x50/10"x20" Base	11	1,38	21,78	36	49,68	807,08
		10x50/4"x20" Listelo	10	0,50	9,00	48	24,00	455,00
		50x50/20"x20" Base	4	1,00	20,52	36	36,00	761,72
		8x50/3"x20" Rodapié	10	0,40	9,60	120	48,00	1175,00
MIXIT	75x75/30"x30" Base / Antislip	2	1,13	24,62	42	47,46	1057,04	
	37x75/15"x30" Base / Antislip	4	1,13	24,24	48	54,24	1186,52	
	26x58/10"x24" Muro	5	0,75	15,10	30	22,50	476,00	
	30x90/12"x36" Base / Concept / Art	4	1,08	18,84	51	55,08	983,84	
	1,5x90/1,8"x36" Perfil	6	0,08	0,90	336	27,22	325,40	
	30x30/12"x12" Mosaico	11	1,00	20,46	36	36,00	759,56	
	8x75/3"x30" Rodapié	10	0,60	12,90	80	48,00	1055,00	
	37x75/15"x30" Peldaño Base / Antislip	4	1,11	24,24		Please ask for information / Consulte información		
	37x75/15"x30" Peldaño Doble Base / Antislip	2	0,56	12,12		Please ask for information / Consulte información		
	30x90/12"x36" Base	4	1,08	18,84	51	55,08	983,84	
MOOD	1,5x90/1,8"x36" Perfil	6	0,08	0,90	336	27,22	325,40	
	100x50/40"x20" Base / Antislip	2	1,00	23,60	28	28,00	683,80	
	75x75/30"x30" Base / Antislip	2	1,13	24,62	42	47,46	1057,04	
	75x75/30"x30" 20 MM	1	0,56	24,91	42	23,52	1069,22	
	60x60/24"x24" Base	3	1,08	22,53	40	43,20	924,20	
	60x60/24"x24" 20 MM	2	0,72	31,72	32	23,04	1038,04	
	37x75/15"x30" Base / Antislip	4	1,13	24,24	48	54,24	1186,52	
	50x50/20"x20" Base	4	1,00	20,52	36	36,00	761,72	
	30x90/12"x36" Base / Concept	4	1,08	18,84	51	55,08	983,84	
	1,5x90/0,8"x36" Perfil Acero	6	0,08	0,90	336	27,22	325,40	
NATURE	30x30/12"x12" Mosaico	11	1,00	20,46	36	36,00	759,56	
	26x58/10"x24" Muro	5	0,75	7,00	30	22,50	233,00	
	8x60/3"x24" Rodapié	10	0,48	11,30	80	38,40	943,00	
	30x60/12"x24" Peldaño	6	1,08	20,58		Please ask for information / Consulte información		
	30x60/12"x24" Peldaño Doble	2	0,36	13,28		Please ask for information / Consulte información		
	8x75/3"x30" Rodapié	10	0,60	12,90	80	48,00	1055,00	
	37x75/15"x30" Peldaño/Peldaño Antislip	4	1,11	24,24		Please ask for information / Consulte información		
	37x75/15"x30" Peldaño Doble / Peldaño Doble Antislip	2	0,56	12,12		Please ask for information / Consulte información		
	75x75/30"x30" Peldaño 20MM	1	0,56	24,91	42	23,64	1069,22	
	8x50/3"x20" Rodapié	10	0,40	9,60	120	48,00	1175,00	
PALATINO	100x50/40"x20" Peldaño/Peldaño Antislip	2	1,00	25,20		Please ask for information / Consulte información		
	100x50/40"x20" Peldaño Doble / Peldaño Doble Antislip	2	1,00	28,34		Please ask for information / Consulte información		
	73x73/28"x28" Base	2	1,07	23,96	42	44,94	1029,32	
	36x73/14"x28" Base	4	1,07	23,60	48	51,36	1155,80	
	18x73/7"x28" Base	9	1,19	25,20	48	57,12	1232,60	
	5x36/2"x14" Listelo	10	0,18	2,60	120	21,60	335,00	
	26x58/10"x24" Muro	5	0,75	15,10	30	22,50	476,00	
	30x30/12"x12" Mosaico	11	1,00	20,46	36	36,00	759,56	

Item Artículo	Size Formato	pcs - box pzs - cj	m2/box m2/cj	kg/box kg/cj	box/epi cj/epi	m2/epi	kg/epi
PETIT GRANIT	60x60/24"x24" Base	3	1.08	22.53	40	43.20	924.20
	30x60/12"x24" Base	6	1.08	22.32	40	43.20	915.80
	30x30/12"x12" Mosaico	11	1.00	20.46	36	36.00	759.56
	8x60/3"x24" Rodapié	10	0.48	11.30	80	38.40	943.00
	30x60/12"x24" Peldaño	6	1.08	20.58	Please ask for information / Consulte información		
	30x60/12"x24" Peldaño Doble	2	0.36	13.28	Please ask for information / Consulte información		
PORTOBELLO	100x24,8/40"x10" Base / Antislip	3	0.74	17.67	40	29.60	729.80
	18,5x75/7"x30" Base / Antislip	8	1.11	24.64	48	53.28	1205.72
	8x50/3"x20" Rodapié	10	0.40	9.60	120	48	1175.00
	100x24,8/40"x10" Peldaño Base / Antislip	3	0.74	22.50	Please ask for information / Consulte información		
	100x24,8/40"x10" Peldaño Doble Base / Antislip	2	0.50	12.60	Please ask for information / Consulte información		
	60x60/24"x24" Base / Antislip / Modul	3	1.08	22.53	40	43.20	924.20
PRIORAT	30x60/12"x24" Base / Antislip	6	1.08	22.32	40	43.20	915.80
	25x70/10"x28" Base / Concept	7	1.23	21.35	42	51.66	919.70
	5,8x70/2,3"x28" Listelo	6	0.24	4.80	144	35.08	714.20
	30x30/12"x12" Mosaico	11	1.00	20.46	36	36.00	759.56
	22,8x39/9"x15" Muro	5	0.44	9.50	42	18.48	422.00
	8x60/3"x24" Rodapié	10	0.48	11.30	80	38.40	943.00
	30x60/12"x24" Peldaño Base / Antislip	6	1.08	20.58	Please ask for information / Consulte información		
	30x60/12"x24" Peldaño Doble Base / Antislip	2	0.36	13.28	Please ask for information / Consulte información		
	60x60/24"x24" Base / Antislip	3	1.08	22.53	40	43.20	924.20
	30x60/12"x24" Base	6	1.08	22.32	40	43.20	915.80
REMAKE	25x70/10"x28" Base / Concept	7	1.23	21.35	42	51.66	919.70
	3,8x70/15"x27" Listelo	6	0.16	3.06	144	22.98	463.64
	1,5x70/1,8"x28" Perfil	6	0.06	0.72	400	25.20	311.00
	30x30/12"x12" Mosaico	11	1.00	20.46	36	36.00	759.56
	8x60/3"x24" Rodapié	10	0.48	11.30	80	38.40	943.00
	30x60/12"x24" Peldaño Base / Antislip	6	1.08	20.58	Please ask for information / Consulte información		
	30x60/12"x24" Peldaño Doble Base / Antislip	2	0.36	13.28	Please ask for information / Consulte información		
	150x24,8/60"x10" Base / Antislip	3	1.12	26.79	40	44.80	1094.60
	18,5x75/7"x30" Base / Antislip	8	1.11	24.64	48	53.28	1205.72
	8x75/3"x30" Rodapié	10	0.60	12.90	80	48.00	1055.00
SAVIA	150x37/60"x15" Peldaño Base / Antislip	2	1.11	26.80	Please ask for information / Consulte información		
	150x37/60"x15" Peldaño Doble Base / Antislip	2	1.11	26.80	Please ask for information / Consulte información		
	150x37/60"x15" Peldaño Base / Antislip Izquierdo / Derecho	ND	ND	ND	ND	ND	ND
	150x37/60"x15" Peldaño Base / Antislip Doble Izquierdo / Derecho	ND	ND	ND	ND	ND	ND
	8x37/3"x15 Zanquin Izquierdo / Derecho	ND	ND	ND	ND	ND	ND
	25x70/10"x28" Base / Líneas	7	1.23	21.35	42	51.66	919.70
SOHO	25x70/10"x28" Decor	3	0.52	10.08	42	22.05	446.36
	3,8x70/1,5"x28" Listelo	6	0.16	3.06	144	22.98	463.64
	50x50/20"x20" Base	4	1.00	20.52	36	36.00	761.72
	8x50/3"x20" Rodapié	10	0.40	9.60	120	48.00	1175.00
	75x75/30"x30" Base / Soft	2	1.13	24.62	42	47.46	1057.04
STONETECH	75x75/30"x30" 20 MM	1	0.56	24.91	42	23.52	1069.22
	60x60/24"x24" Base	3	1.08	22.53	40	43.20	924.20
	60x60/24"x24" 20 MM	2	0.72	31.72	32	23.04	1038.04
	30x60/12"x24" Base	6	1.08	22.32	40	43.20	915.80
	8x60/3"x24" Rodapié	10	0.48	11.3	80	38.40	943.00
	30x60/12"x24" Peldaño	6	1.08	20.58	Please ask for information / Consulte información		
	30x60/12"x24" Peldaño Doble	2	0.36	13.28	Please ask for information / Consulte información		
	60x60/24"x24" Peldaño 20 MM	2	0.71	31.72	32	23.04	1038.04
	75x75/30"x30" Peldaño 20 MM	1	0.56	24.91	42	23.52	1069.22
	25x50/10"x20" Base / Concept	11	1.38	21.78	36	49.68	807.08
TERMAE	8,6x25/3,4"x10" Listelo	18	0.39	7.38	150	58.05	1130.00
	5x25/2"x10" Bullnose	22	0.28	3.30	150	41.25	551.00
	33x33/13"x13" Mosaico	10	1.09	19.00	36	39.24	707.00
	50x50/20"x20" Base	4	1.00	20.52	36	36.00	761.72
	33x33/13"x13" Base	11	1.21	22.55	48	58.08	1105.4
THAI	25x70/10"x28" Base	7	1.23	21.35	42	51.66	919.70
	11,8x70/4,6"x27,6" Listelo	4	0.33	6.32	80	26.43	528.60
	3,8x70/1,5"x28" Listelo	4	0.11	2.12	144	15.32	328.28

Item Artículo	Size Formato	pcs - box pzs - cj	m2/box m2/cj	kg/box kg/cj	box/epi cj/epi	m2/epi	kg/epi
UPTOWN	150x75/60"x30" Base	1	1.12	26.80	48	53.76	1309.40
	150x37/60"x15" Base / Concept	2	1.12	26.80	50	56.00	1363.00
	75x75/30"x30" Base / Antislip / Modul	2	1.13	24.62	42	47.46	1057.04
	75x75/30"x30" 20 MM	1	0.56	24.91	42	23.52	1069.22
	60x60/24"x24" Base	3	1.08	22.53	40	43.20	924.20
	60x60/24"x24" 20 MM	2	0.72	31.72	32	23.04	1038.04
	37x75/15"x30" Base / Antislip	4	1.13	24.24	48	54.24	1186.52
	30x90/12"x36" Base / Concept / Art	4	1.08	18.84	51	55.08	983.84
	25x50/10"x20" Base / Concept	11	1.38	23.54	36	49.68	870.44
	4,6x50/1,8"x20" Listelo	10	0.23	4.00	120	27.60	503.00
	50x50/20"x20" Base	4	1.00	20.52	36	36.00	761.72
	1,5x50/1,8"x20" Perfil	6	0.05	0.48	400	18.00	215.00
	4,8x30/1,9"x12" Listelo	11	0.16	3.30	110	17.42	386.00
	7x30/2,7"x12" Listelo	12	0.25	5.04	90	22.68	476.60
	12,5x30/4,9"x12" Zócalo	6	0.22	4.80	110	24.75	551.00
URBAN	1,5x90/0,8"x36" Perfil	6	0.08	0.90	336	27.22	325.40
	30x30/12"x12" Mosaico	11	1.00	20.46	36	36.00	759.56
	8x50/3"x20" Rodapié	10	0.40	9.60	120	48.00	1175.00
	150x37/60"x15" Peldaño	2	1.11	26.80	Please ask for information / Consulte información		
	150x37/60"x15" Peldaño Doble	2	1.11	26.80	Please ask for information / Consulte información		
	8x60/3"x24" Rodapié	10	0.48	11.30	80	38.40	943.00
	30x60/12"x24" Peldaño	6	1.08	20.58	Please ask for information / Consulte información		
	30x60/12"x24" Peldaño Doble	2	0.36	13.28	Please ask for information / Consulte información		
	8x75/3"x30" Rodapié	10	0.60	12.90	80	48.00	1055.00
	37x75/15"x30" Peldaño Base / Antislip	4	1.11	24.24	Please ask for information / Consulte información		
	37x75/15"x30" Peldaño Doble Base / Antislip	2	0.56	12.12	Please ask for information / Consulte información		
	100x50/40"x20" Base	2	1.00	23.60	28	28.00	683.80
	60x60/24"x24" Base / Antislip	3	1.08	22.53	40	43.20	924.20
	30x60/12"x24" Base / Antislip	6	1.08	22.32	40	43.20	915.80
	30x30/12"x12" Mosaico	11	1.00	20.46	36	36.00	759.56
VELVET	8x60/3"x24" Rodapié	10	0.48	11.30	80	38.40	943.00
	30x60/12"x24" Peldaño Base / Antislip	6	1.08	20.58	Please ask for information / Consulte información		
	30x60/12"x24" Peldaño Doble Base / Antislip	2	0.36	13.28	Please ask for information / Consulte información		
	100x50/40"x20" Peldaño	2	1.00	25.20	Please ask for information / Consulte información		
	100x50/40"x20" Peldaño Doble	2	1.00	28.34	Please ask for information / Consulte información		
	30x90/12"x36" Base / Modul	4	1.08	18.84	51	55.08	983.84
VILLAGE	30x90/12"x36" Decor	4	1.08	21.60	12	12.96	282.20
	30x30/12"x12" Malla	9	0.81	15.57	42	34.02	676.94
	5,8x90/2,3"x35,4" Listelo	6	0.31	6.30	56	17.54	375.80
WALL BRICK	100x50/40"x20" Base	3	0.74	17.67	40	29.60	729.80
	18,5x75/7"x30" Base	8	1.11	24.64	48	53.28	1205.72
	8x50/3"x20" Rodapié	10	0.40	9.60	120	48.00	1175.00
	100x24,8/40"x10" Peldaño	3	0.74	22.50	Please ask for information / Consulte información		
ZEBRA	100x24,8/40"x10" Peldaño Doble	2	0.50	12.60	Please ask for information / Consulte información		
	30x90/12"x36" Base	4	1.08	18.84	51	55.08	983.84
	100x50/40"x20" Base	2	1.00	23.60	28	28.00	683.80



Keraben reserves the rights to delete and amend, either totally or partially, any of the styles, colours, shapes, sizes, references and other technical specifications contained in this catalogue.

The entire contents of this catalogue are Copyright.

No pictures, texts, illustrations or graphic concepts may be reproduced, either wholly or partially, without the express permission of Keraben.

Keraben certifies that all products included in this catalogue are made in Spain at its production plants in Nules (Castellón) and, in the case of certain special parts, in countries of the European Union.

All colors and hues appearing in this catalogue should be considered approximate only on view of the printing processes involved.

Keraben se reserva el derecho de anular y modificar, total, o parcialmente, cualquiera de los modelos, colores, formatos, referencias y especificaciones técnicas contenidas en este catálogo.

El contenido de este catálogo está protegido en su totalidad por Copyright. Queda prohibida la reproducción total o parcial de las imágenes, textos, ilustraciones, y conceptos gráficos sin la autorización expresa de Keraben.

Keraben certifica que todos los productos incluidos en el presente catálogo están fabricados en sus plantas productivas de Nules, provincia de Castellón, España, y en el caso de determinadas piezas especiales, en países de la Unión Europea.

Debido a los procesos de impresión, los colores que aparecen en este catálogo deben de considerarse aproximados, no exactos.

Keraben

Keraben Grupo, S.A.
Ctra. Valencia-Barcelona, Km. 44,3 12520 Nules (Castellón) - Spain
Telf. +34 964 659 500 - Fax. +34 964 674 245
marketing@keraben.com

@KerabenGrupo
www.keraben.com

