

KOPALNICE

BATHROOMS

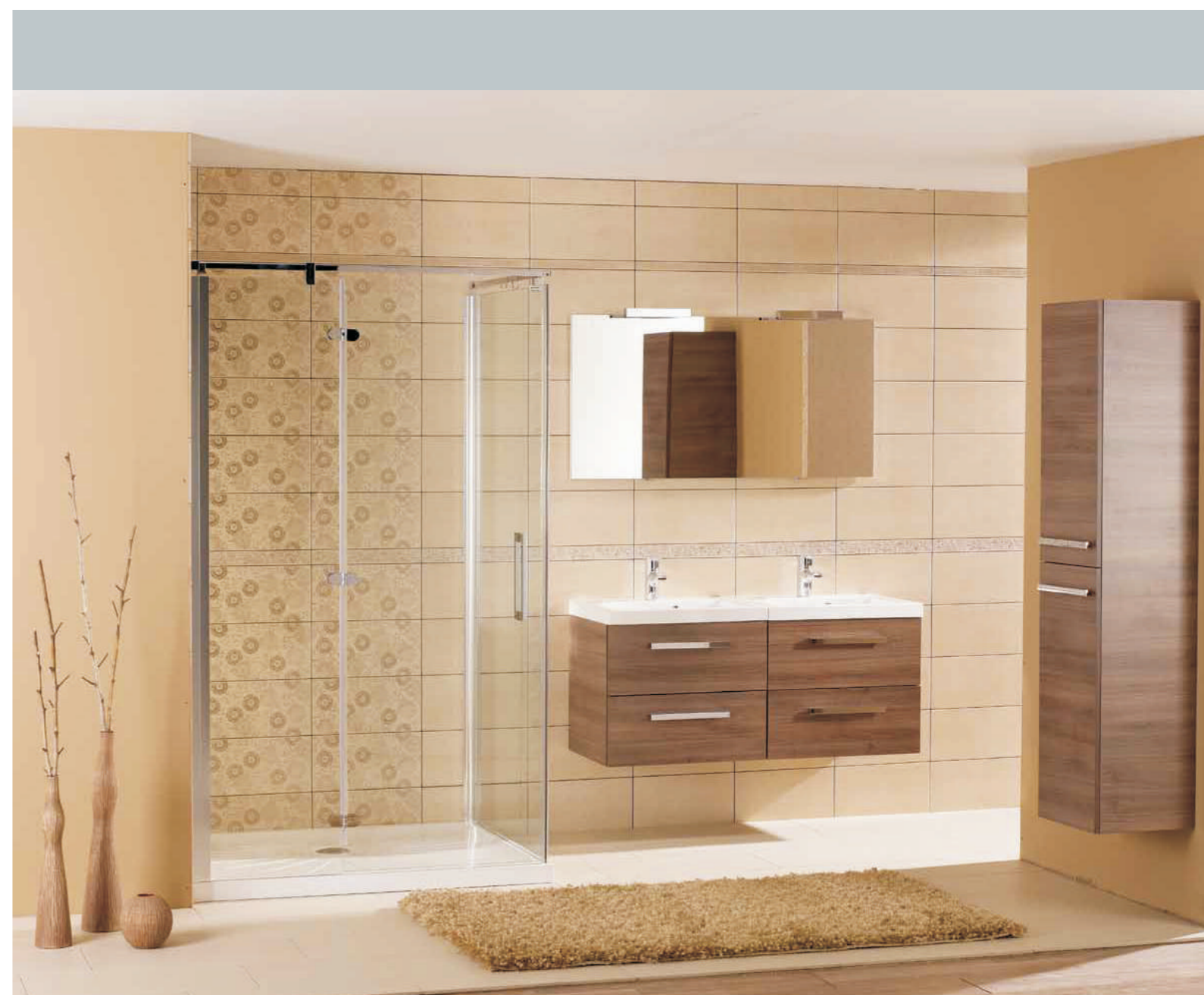

www.gorenje-no.si

Izbrano. Večno.
Izbrane najbolj kakovostne komponente tvorijo material za izdelavo sanitarne opreme gorenje. To ji daje dolgo življenjsko dobo in omogoča enostavno vzdrževanje.

Odabrano. Vječno.
Samo najkvalitetnejše komponente čine material za izradu sanitarne opreme gorenje. To joj omogočuje dug životni vijek i jednostavno održavanje.

Selected. Eternal.
Only components of the highest quality are used in the production of the gorenje sanitary ware. This gives it a long service life and allows easy care.

Auserwählt. Ewig.
Nur die Spitzenkomponenten bilden das Material zur Herstellung der gorenje Sanitäreinrichtung und sichern eine lange Lebensdauer und einfache Wartung.



IZBRANO. VEČNO.

Dovršeno. Izkušeno.
Tri desetletja razvoja in izkušenj nam dajejo znanje za ustvarjanje dovršenega kopalniškega prostora.

Dorađeno. Provjereno.
Tri desetljeća razvoja i iskustva nude nam znanje za stvaranje dorađenoga kupaoničkoga prostora.

Perfect. Experienced.
In three decades of development and experience, we have gained expertise to create perfect bathroom space.

Perfekt. Erfahren.
Drei Jahrzehnte der Entwicklung und Erfahrungen sind die Garantie für unsere Kenntnisse, das perfekte Badezimmer zu errichten.



DOVRŠENO. IZKUŠENO.

INDEX PAGE

Sestavljeno kopalniško pohištvo
Sastavljeni namještaj za kupaonice
Assembled bathroom furniture
Badezimmer – Modulare Möbel

MODERN TREND	NEW CLASSIC	STANDARD
ALANO 6	JULIJA 42	QUADRA 56
AMADOR 8		QUADRA+ 60
LEONIDES 10		
LORENCIO 12		
BONSAI 14		
JAZZ 16		
OASIS 22		
AVON 30		
SLIM 38		

Razstavljeno kopalniško pohištvo
Rastavljeni namještaj za kupaonice
Unassembled bathroom furniture
Badezimmer - zerlegbare Möbel

FRESH KARISMA 48
CATANIA 54

Sanitarna oprema
Sanitarna oprema
Sanitary ware
Sanitäreinrichtung

TOALETNE ŠKOLJKE, BIDEJI 65
TUŠ KADI IN KABINE 66
MASAŽNA TUŠIRNA STENA 71
KOPALNE KADI 70
DODATNA OPREMA 74

Pregled ponudbe
Pregled ponude
Our offer
Prüfung des Angebots

OGLEDALA 76
OMARICE Z OGLEDALI 77
SVETILKE 78
ROČAJI 79





MODERN TREND

Alano	6
Amador	8
Leonides	10
Lorencio	12
Bonsai	14
Jazz	16
Oasis	22
Avon	30
Slim	38

Čiste linije in izbrane barvne kombinacije rišejo prostor modernega navdiha in drznih idej.

Čiste linije i odabrane kombinacije boja crtaju prostor moderne inspiracije i smjelih ideja.

Clean lines and selected colour combinations design space of modern inspiration and bold ideas.

Klare Linien und ausgewählte Farbkombinationen zeichnen den Raum der modernen Inspiration und kühnen Ideen.

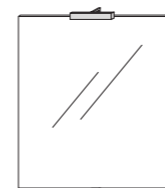

Ogledalo 60x80 cm s svetilko
Ogledalo 60x80 cm sa svjetiljkom
Mirror 60x80 cm with light fitting
Spiegel 60x80 mit leuchte
• 60/80/2
80,81 PT *

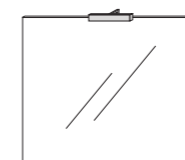

Ogledalo 80x60 cm s svetilko
Ogledalo 80x60 cm sa svjetiljkom
Mirror 80x60 cm with light fitting
Spiegel 80x60 mit leuchte
• 80/60/2
80,73 PT *

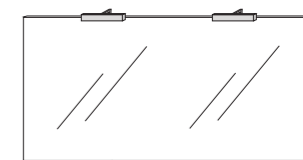

Ogledalo 120x60 cm s svetilko
Ogledalo 120x60 cm sa svjetiljkom
Mirror 120x60 cm with light fitting
Spiegel 120x60 mit leuchte
• 120/60/2
132,53 PT *

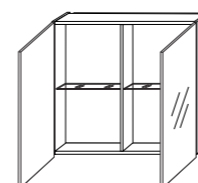

F 60.15
Element z ogledali
Element s ogledalima
Wall cabinet with mirrors
Spiegelschrank
• 60/60,5/15
87,91 PT *

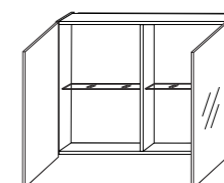

F 80.15
Element z ogledali
Element s ogledalima
Wall cabinet with mirrors
Spiegelschrank
• 80/60,5/15
99,27 PT *

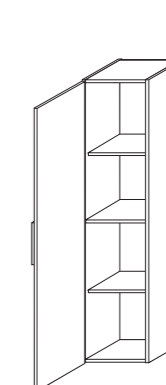

D 35.07 L,D
Visoka omara L,D
Visoki ormar L,R
Hochschrank L,R
• 35/130/30
113,22 PT *

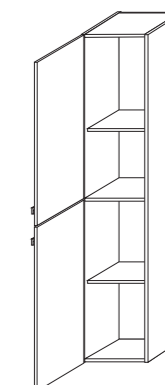

E 35.07 L,D
Visoka omara I,D
Visoki ormar I,R
Hochschrank I,R
• 35/160/35
149,59 PT *

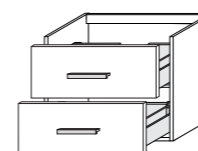

F 60.82
Element pod umivalnikom
Element ispod umivaonika
Vanity cabinet
Waschbeckenunterschrank
• 60/50/45,5
215,56 PT *

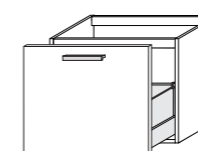

F 80.87
Element pod umivalnikom
Element ispod umivaonika
Vanity cabinet
Waschbeckenunterschrank
• 80/50/45,5
142,49 PT *

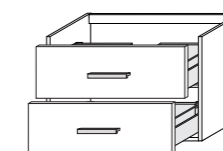

F 80.82
Element pod umivalnikom
Element ispod umivaonika
Vanity cabinet
Waschbeckenunterschrank
• 80/50/45,5
225,63 PT *

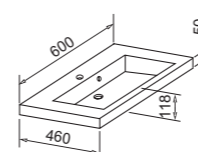

UM 60.95
Umivalnik
Umivaonik
Basin
Waschbecken
113,78 PT *

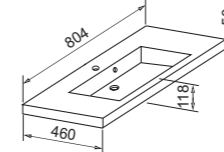

UM 80.95
Umivalnik
Umivaonik
Basin
Waschbecken
123,31 PT *

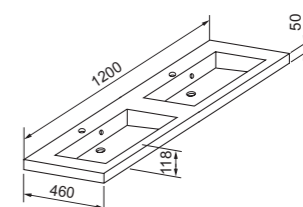

UM 120.96
Umivalnik
Umivaonik
Basin
Waschbecken
169,57 PT *



Staklena polica
Staklena polica
glass shelf
glasablage
• 60/0,8/15
12,48 PT *



Staklena polica
Staklena polica
glass shelf
glasablage
• 90/0,8/15
14,55 PT *



Vrata / Vrata / Door / Front

Vrata:
• oplemenitena iverna plošča:
črna sijaj, robni trak Alu efekt

Vrata:
• oplemenjena iverica:
crna sijaj

Door:
• laminated particle board:
black gloss

Front:
• Kunststofoberfläche:
Schwarz glanz

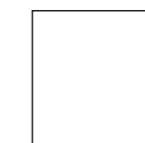

Obod / Obod / Body / Korpus

Obod:
• oplemenitena iverna plošča:
bela sijaj

Obod:
• oplemenjena iverica:
bijela sjaj

Body:
• laminated particle board:
white gloss

Korpus:
• Kunststofoberfläche:
Weiss glanz

AMADOR

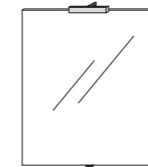

Ogledalo 60x80 cm s svetilko
Ogledalo 60x80 cm sa svjetiljkom
Mirror 60x80 cm with light fitting
Spiegel 60x80 mit leuchte
• 60/80/2
80,81 PT *

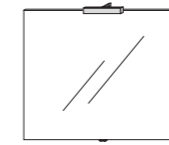

Ogledalo 80x60 cm s svetilko
Ogledalo 80x60 cm sa svjetiljkom
Mirror 80x60 cm with light fitting
Spiegel 80x60 mit leuchte
• 80/60/2
80,73 PT *

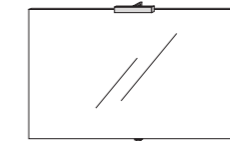

Ogledalo 100x60 cm s svetilko
Ogledalo 100x60 cm sa svjetiljkom
Mirror 100x60 cm with light fitting
Spiegel 100x60 mit leuchte
• 100/60/2
86,80 PT *

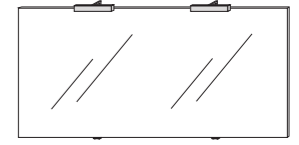

Ogledalo 120x60 cm s svetilko
Ogledalo 120x60 cm sa svjetiljkom
Mirror 120x60 cm with light fitting
Spiegel 120x60 mit leuchte
• 120/60/2
132,53 PT *

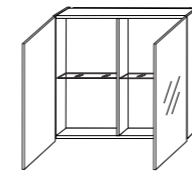

F 60.15
Element z ogledali
Element s ogledalima
Wall cabinet with mirrors
Spiegelschrank
• 60/60,5/15
87,91 PT *

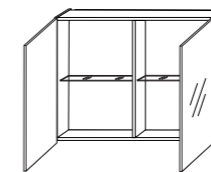

F 80.15
Element z ogledali
Element s ogledalima
Wall cabinet with mirrors
Spiegelschrank
• 80/60,5/15
99,27 PT *

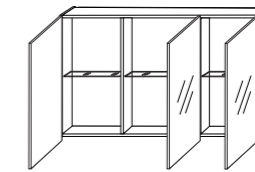

F 100.15
Element z ogledali
Element s ogledalima
Wall cabinet with mirrors
Spiegelschrank
• 100/60,5/15
123,14 PT *

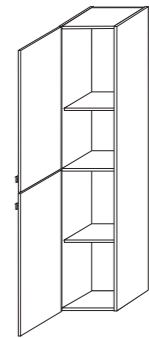

E 35.07 L,D
Visoka omara L,D
Visoki ormar L,D
Tall cabinet L,R
Hochschrank L,R
• 35/160/35
178,71 PT *

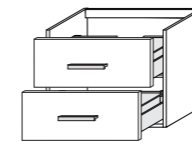

F 60.82
Element pod umivalnikom
Element ispod umivaonika
Vanity cabinet
Waschbeckenunterschrank
• 60/50/45,5
220,74 PT *

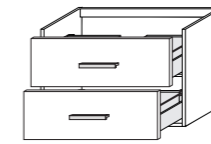

F 80.82
Element pod umivalnikom
Element ispod umivaonika
Vanity cabinet
Waschbeckenunterschrank
• 80/50/45,5
235,36 PT *

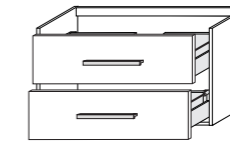

F 100.82
Element pod umivalnikom
Element ispod umivaonika
Vanity cabinet
Waschbeckenunterschrank
• 100/50/45,5
275,84 PT *

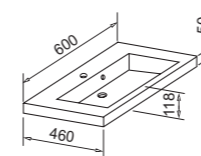

UM 60.95
Umivalnik
Umivaonik
Basin
Waschbecken
113,78 PT *

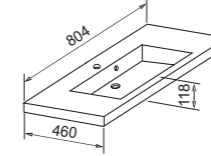

UM 80.95
Umivalnik
Umivaonik
Basin
Waschbecken
123,31 PT *

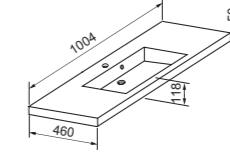

UM 100.95
Umivalnik
Umivaonik
Basin
Waschbecken
139,76 PT *

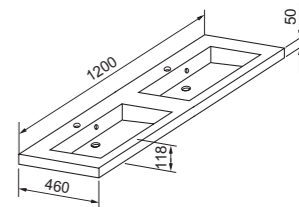

UM 120.96
Umivalnik
Umivaonik
Basin
Waschbecken
169,57 PT *



Steklena polica
Staklena polica
glass shelf
glasablage
• 60/0,8/15
12,48 PT *



Steklena polica
Staklena polica
glass shelf
glasablage
• 90/0,8/15
14,55 PT *

Barvna kombinotorika vrata-korpus: barva ali tekstura lesa na vratih je vedno lahko le enaka kot barva ali tekstura lesa na korpusu.
Npr.: Antracit korpus, antracit vrata = OK. Korpus hrast rjavi in bela vrata NI možno!

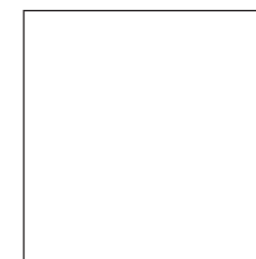

Vrata: bela folija sijaj
Korpus: bela oplemenitena iverna pl. sijaj



Vrata: vlaknena plošča MDF, antracit lak
Korpus: bela oplemenitena iverna pl. antracit lak



Vrata in korpus: hrast rjavi oplemenitena iverna plošča



Vrata in korpus: hrast srebrni oplemenitena iverna plošča



Vrata in korpus: teak Karisma oplemenitena iverna plošča

LEONIDES

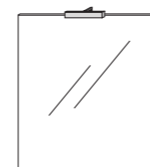

Ogledalo 60x80 cm s svetilko
Ogledalo 60x80 cm sa svjetiljkom
Mirror 60x80 cm with light fitting
Spiegel 60x80 mit leuchte
• 60/80/2
80,81 PT *

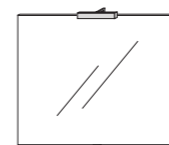

Ogledalo 80x60 cm s svetilko
Ogledalo 80x60 cm sa svjetiljkom
Mirror 80x60 cm with light fitting
Spiegel 80x60 mit leuchte
• 80/60/2
80,73 PT *

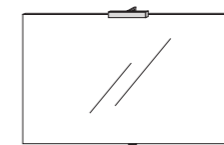

Ogledalo 100x60 cm s svetilko
Ogledalo 100x60 cm sa svjetiljkom
Mirror 100x60 cm with light fitting
Spiegel 100x60 mit leuchte
• 100/60/2
86,80 PT *

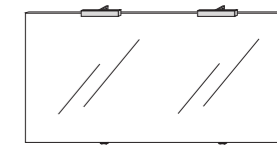

Ogledalo 120x60 cm s svetilko
Ogledalo 120x60 cm sa svjetiljkom
Mirror 120x60 cm with light fitting
Spiegel 120x60 mit leuchte
• 120/60/2
132,53 PT *

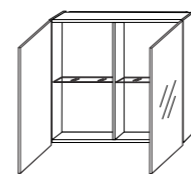

F 60.15
Element z ogledali
Element s ogledalima
Wall cabinet with mirrors
Spiegelschrank
• 60/60,5/15
87,91 PT *

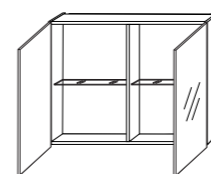

F 80.15
Element z ogledali
Element s ogledalima
Wall cabinet with mirrors
Spiegelschrank
• 80/60,5/15
99,27 PT *

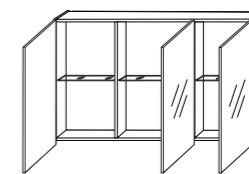

F 100.15
Element z ogledali
Element s ogledalima
Wall cabinet with mirrors
Spiegelschrank
• 100/60,5/15
123,14 PT *

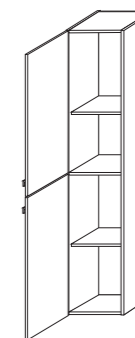

E 35.07 L,D
Visoka omara L,D
Visoki ormar L,D
Tall cabinet L,R
Hochschrank L,R
• 35/160/35
178,71 PT *

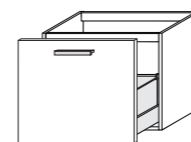

F 60.83
Element pod umivalnikom
Element ispod umivaonika
Vanity cabinet
Waschbeckenunterschrank
• 60/45/45,5
149,96 PT *

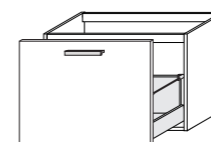

F 80.83
Element pod umivalnikom
Element ispod umivaonika
Vanity cabinet
Waschbeckenunterschrank
• 80/45/45,5
166,94 PT *

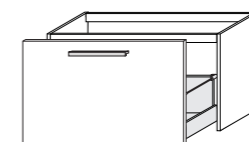

F 100.83
Element pod umivalnikom
Element ispod umivaonika
Vanity cabinet
Waschbeckenunterschrank
• 100/45/45,5
194,07 PT *

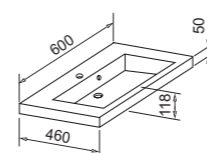

UM 60.95
Umivalnik
Umivaonik
Basin
Waschbecken
113,78 PT *

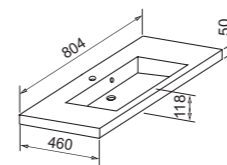

UM 80.95
Umivalnik
Umivaonik
Basin
Waschbecken
123,31 PT *

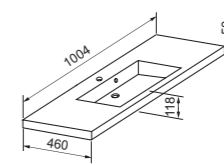

UM 100.95
Umivalnik
Umivaonik
Basin
Waschbecken
139,76 PT *

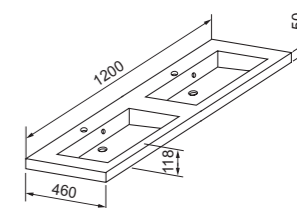

UM 120.96
Umivalnik
Umivaonik
Basin
Waschbecken
169,57 PT *



Steklena polica
Staklena polica
glass shelf
glasablage
• 60/0,8/15
12,48 PT *



Steklena polica
Staklena polica
glass shelf
glasablage
• 90/0,8/15
14,55 PT *

Barvna kombinotorika vrata-korpus: barva ali tekstura lesa na vratih je vedno lahko le enaka kot barva ali tekstura lesa na korpusu.
Npr.: Antracit korpus, antracit vrata = OK. Korpus hrast rjavi in bela vrata NI možno!

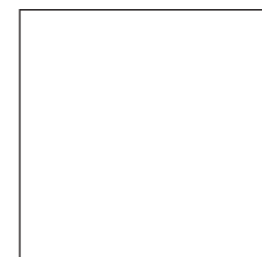

Vrata: bela folija sijaj
Korpus: bela oplemenitena iverna pl. sijaj



Vrata: vlaknena plošča MDF, antracit lak
Korpus: bela oplemenitena iverna pl. antracit lak

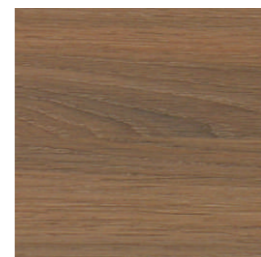

Vrata in korpus: hrast rjavi oplemenitena iverna plošča



Vrata in korpus: hrast srebni oplemenitena iverna plošča

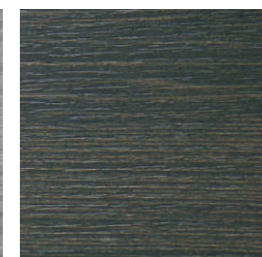

Vrata in korpus: teak Karisma oplemenitena iverna plošča

LORENCIO

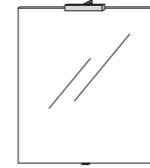

Ogledalo 60x80 cm s svetilko
Ogledalo 60x80 cm sa svetiljkom
Mirror 60x80 cm with light fitting
Spiegel 60x80 mit leuchte
• 60/80/2
80,81 PT *

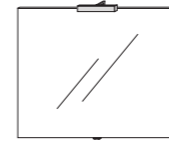

Ogledalo 80x60 cm s svetilko
Ogledalo 80x60 cm sa svetiljkom
Mirror 80x60 cm with light fitting
Spiegel 80x60 mit leuchte
• 80/60/2
80,73 PT *

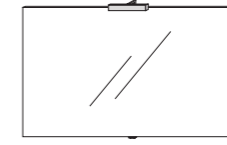

Ogledalo 100x60 cm s svetilko
Ogledalo 100x60 cm sa svetiljkom
Mirror 100x60 cm with light fitting
Spiegel 100x60 mit leuchte
• 100/60/2
86,80 PT *

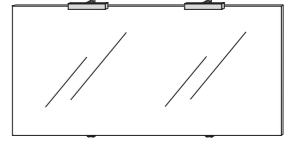

Ogledalo 120x60 cm s svetilko
Ogledalo 120x60 cm sa svetiljkom
Mirror 120x60 cm with light fitting
Spiegel 120x60 mit leuchte
• 120/60/2
132,53 PT *

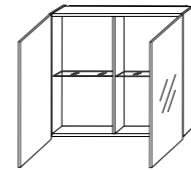

F 60.15
Element z ogledali
Element s ogledalima
Wall cabinet with mirrors
Spiegelschrank
• 60/60,5/15
87,91 PT *

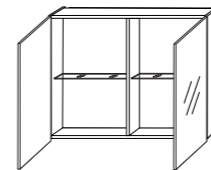

F 80.15
Element z ogledali
Element s ogledalima
Wall cabinet with mirrors
Spiegelschrank
• 80/60,5/15
99,27 PT *

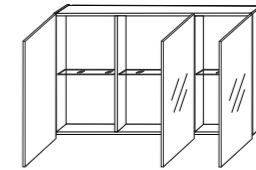

F 100.15
Element z ogledali
Element s ogledalima
Wall cabinet with mirrors
Spiegelschrank
• 100/60,5/15
123,14 PT *

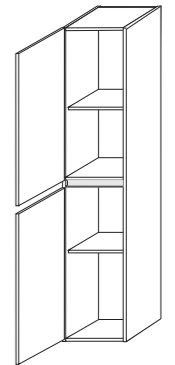

E 35.08 L,D
Visoka omara L,D
Visoki ormar L,D
Tall cabinet L,R
Hochschrank L,R
• 35/160/35
152,37 PT *

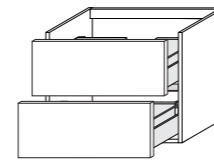

F 60.84
Element pod umivalnikom
Element ispod umivaonika
Vanity cabinet
Washbeckenunterschrank
• 60/50/45,5
213,53 PT *

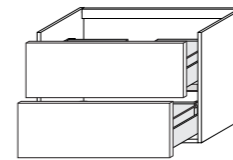

F 80.84
Element pod umivalnikom
Element ispod umivaonika
Vanity cabinet
Washbeckenunterschrank
• 80/50/45,5
234,25 PT *

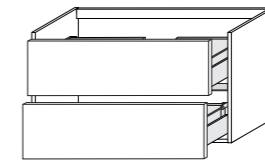

F 100.84
Element pod umivalnikom
Element ispod umivaonika
Vanity cabinet
Washbeckenunterschrank
• 100/50/45,5
267,10 PT *

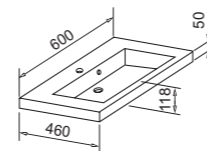

UM 60.95
Umivalnik
Umivaonik
Basin
Washbecken
113,78 PT *

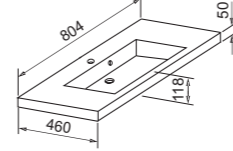

UM 80.95
Umivalnik
Umivaonik
Basin
Washbecken
123,31 PT *

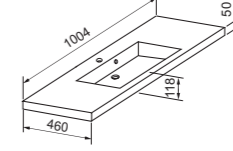

UM 100.95
Umivalnik
Umivaonik
Basin
Washbecken
139,76 PT *

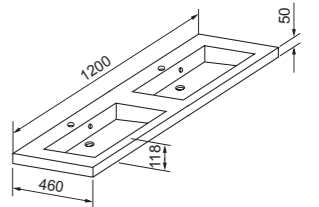

UM 120.96
Umivalnik
Umivaonik
Basin
Washbecken
169,57 PT *



Steklena polica
Staklena polica
glass shelf
glasablage
• 60/0,8/15
12,48 PT *



Steklena polica
Staklena polica
glass shelf
glasablage
• 90/0,8/15
14,55 PT *

Barvna kombinotorika vrata-korpus: barva ali tekstura lesa na vratih je vedno lahko le enaka kot barva ali tekstura lesa na korpusu.
Npr.: Antracit korpus, antracit vrata = OK. Korpus hrast rjavi in bela vrata NI možno!



Vrata: bela folija sijaj
Korpus: bela oplemenitena iverna pl. sijaj



Vrata: vlaknena plošča MDF, antracit lak
Korpus: bela oplemenitena iverna pl. antracit lak

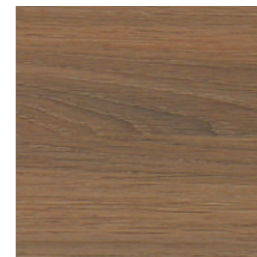

Vrata in korpus: hrast rjavi oplemenitena iverna plošča



Vrata in korpus: hrast srebri oplemenitena iverna plošča



Vrata in korpus: teak Karisma oplemenitena iverna plošča

BONSAI

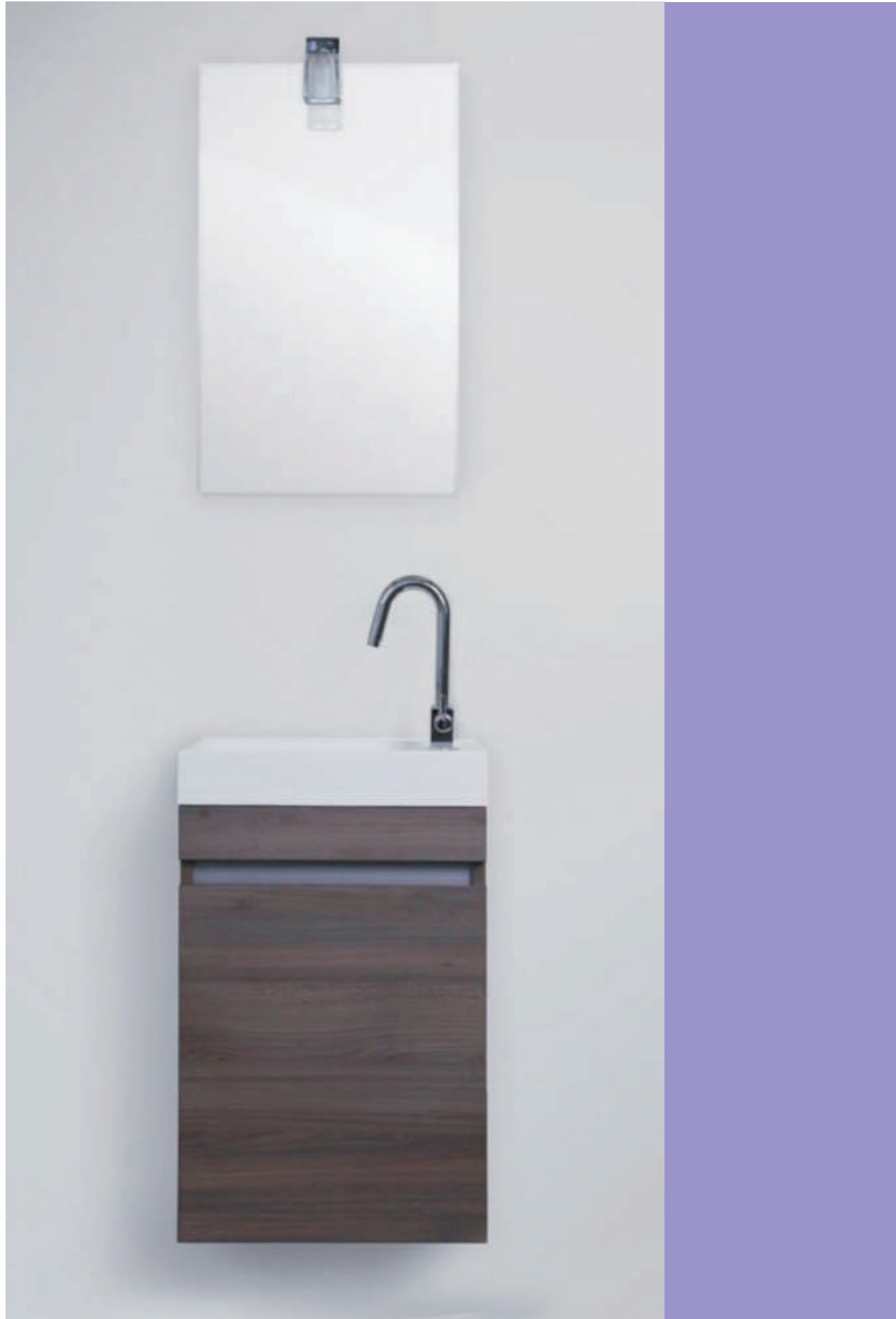

SKG 35.03
Ogledalo 35x75 cm s svetilko
Ogledalo 35x75 cm sa svjetiljkom
Mirror 35x75 cm with light fitting
Spiegel 35x75 cm mit leuchte
• 35/75/2
95,87 PT *

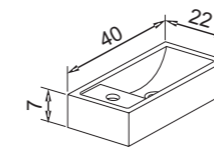

UM 40.193
Umivalnik
Umivaonik
Basin
Waschbecken
101,57 PT *

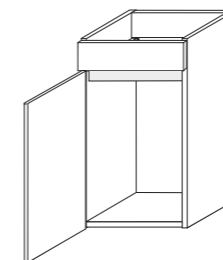

F 40.02 L,D
Element pod umivalnikom
Element ispod umivaonika
Vanity cabinet
Waschbeckenunterschrank
• 40/50/21,6
61,86 PT *

Barvna kombinotorika vrata-korpus: barva ali tekstura lesa na vratih je vedno lahko le enaka kot barva ali tekstura lesa na korpusu.
Npr.: Antracit korpus, antracit vrata = OK. Korpus hrast rjavi in bela vrata NI možno!

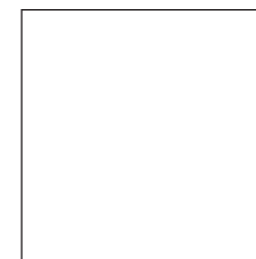

Vrata: bela folija sijaj
Korpus: bela oplemenitena iverna pl. sijaj



Vrata in korpus: hrast rjavi
oplemenitena iverna plošča



Vrata in korpus: hrast srebrni
oplemenitena iverna plošča

JAZZ

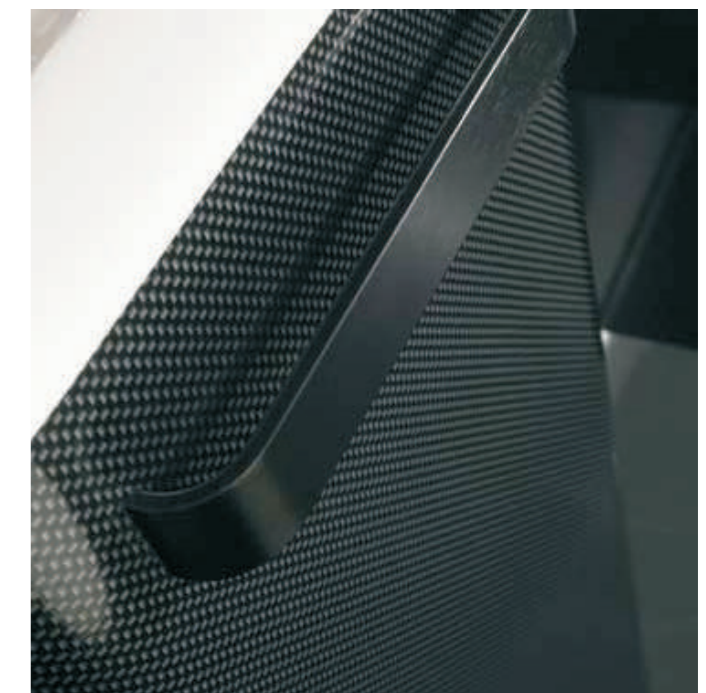

◀ Kopalniško pohištvo:

- Vrata: karbon sijaj
 - Obod: karbon sijaj
 - Ročaj: 95.02 Alu brušen, črn
- Barva sanitarne opreme:
- DOLOPOI BISER

Namještaj za kupaonice:

- Vrata: karbon sjaj
 - Obod: karbon sjaj
 - Ručka: 95.02 Alu brušena, crna
- Boja sanitarne opreme:
- DOLOPOL BISER

Bathroom cabinets:

- Door: carbon gloss
 - Body: carbon gloss
 - Handle: 95.02 brushed aluminium, black
- Sanitary ware colour:
- DOLOPOL BISER

Badezimmermöbel:

- Front: Karbon glanz
 - Korpus: Karbon glanz
 - grif: 95.02 Alu geschlifen, schwarz
- Farbe der Sanitäreinrichtung:
- DOLOPOL BISER

JAZZ

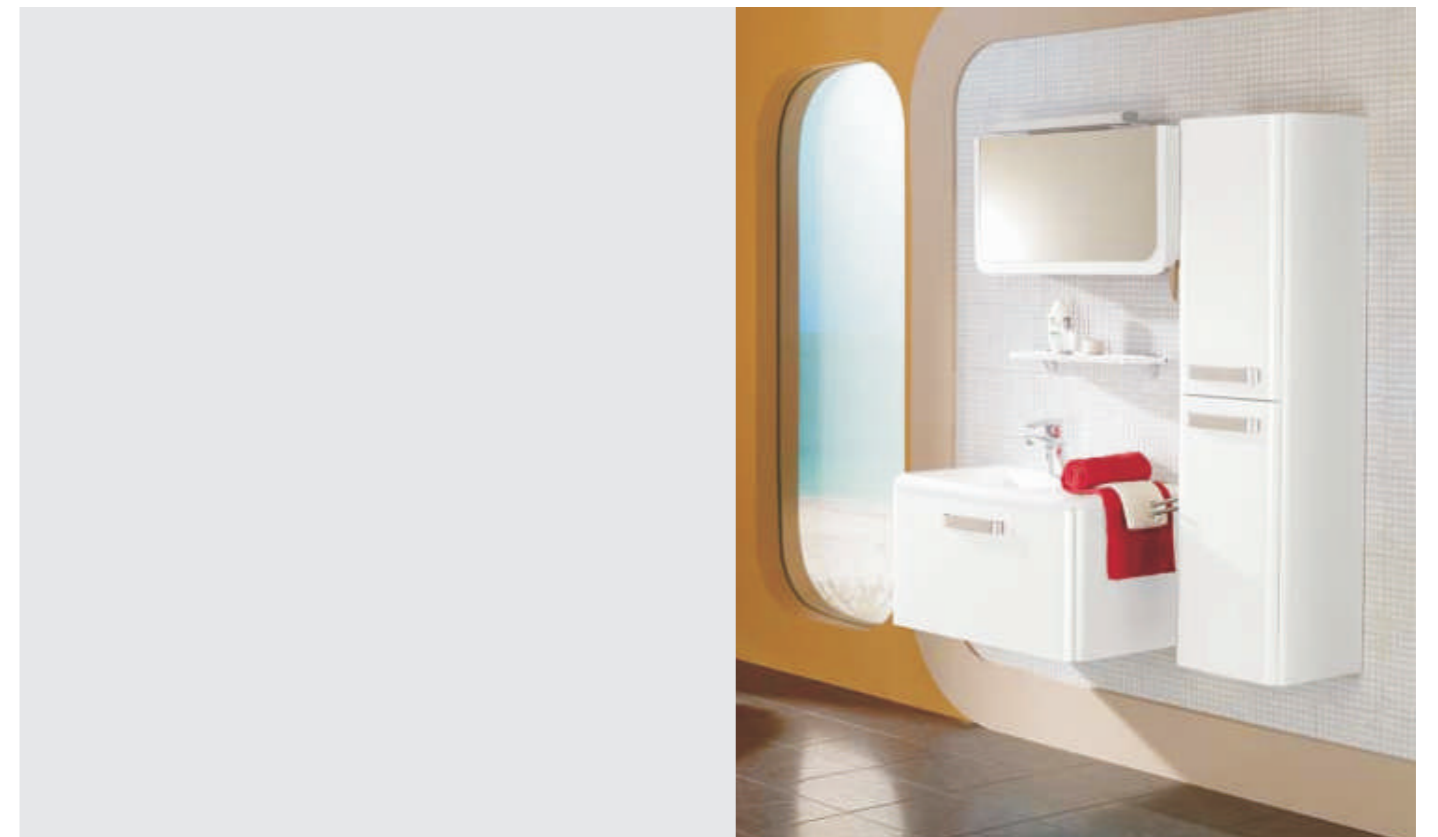

JAZZ

Program elementov / Program elemenata / Bathroom furniture / Typenübersicht

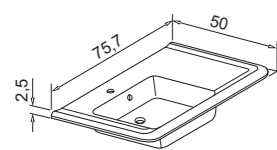

UM 75.145 L
Umivalnik
Umivaonik
Basin UM
Waschbecken
105,97 PT *

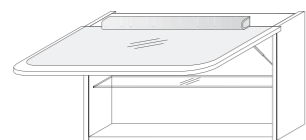

F 70.13
Viseči element z ogledalom in svetilko
Viseči element s ogledalom i svjetiljkom
Wall-mounted mirror cabinet with light fitting
Spiegelschrank mit leuchte
• 75/40/16
268,10 PT *

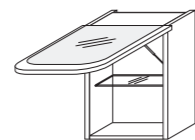

F 35.03
Viseči element z ogledalom
Viseči element s ogledalom
Wall-mounted mirror cabinet
Spiegelschrank
• 35/40/16
80,30 PT *

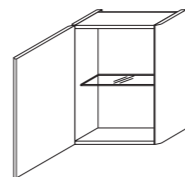

B 35.13 L,D
Viseči element L,D
Viseči element L,D
Wall-mounted cabinet L,R
Wandschrank L,R
• 35/40/16
106,84 PT *

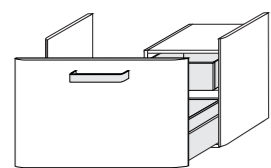

F 75.03
Element pod umivalnikom
Element ispod umivaonika
Vanity cabinet
Waschbeckenunterschrank
• 75/40/49,5
312,25 PT *



SKG 75.03
Ogledalo 75x75 cm s svetilko
Ogledalo 75x75 cm sa svjetiljkom
Mirror 75x75 cm with light fitting
Spiegel 75x75 cm mit leuchte
• 75/75/2
217,75 PT *

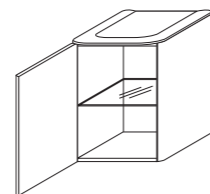

BKG 35.15 L,D
Spodnji element z odlagalno polico iz kompozitnega materiala L,D
Donji element s policom za odlaganje, od kompozitnoga materijala L,D
Base cabinet with functional top made of composite material L,R
Unterschrank mit Ablage aus Kompositmaterial L,R
• 35,6/42,5/33,5
171,37 PT *

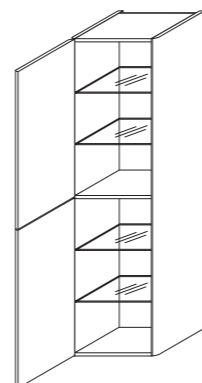

E 35.03 L,D
Visoka omara L,D / Visoki ormar L,D
Tall cabinet L,R / Hochschrank L,R
• 35/145/33
333,06 PT *

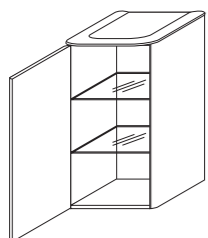

BKG 35.21 L,D
Spodnji element z odlagalno polico iz kompozitnega materiala L,D
Donji element s policom za odlaganje, od kompozitnoga materijala L,D
Base cabinet with functional top made of composite material L,R
Unterschrank mit Ablage aus Kompositmaterial L,R
• 35,6/75/33,5
209,05 PT *

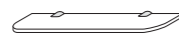

PL 50.01
Polica / Polica
Shelf / Ablage
• 50/1,6/15
24,75 PT *

Vrata in obod:
• Oplaščena vlaknena plošča (MDF): bela mat, rdeča mat, cappuccino mat, oreh sijaj, karbon sijaj



bela mat
bijela mat
white satin
Weiß Matt

Vrata i obod:
• Obložena vlaknatica (MDF): bijela mat, crvena mat, cappuccino mat, orah sijaj, karbon sijaj



rdeča mat
crvena mat
red satin
Rot Matt

Door and body:
• Foiled fibreboard (MDF): white satin, red satin, cappuccino satin, walnut gloss, carbon gloss



oreh sijaj
orah sjaj
walnut gloss
Nuß glanz

Front und Korpus:
• Faserplatte (MDF): Weiß Matt, rot Matt, Cappuccino Matt, Nuß glanz, Karbon glanz



karbon sijaj
karbon sjaj
carbon gloss
Karbon glanz

JAZZ SMALL



bela mat / bijela mat / white satin / Weiß Matt



rdeča mat / crvena mat / red satin / Rot Matt



oreh sijaj / orah sjaj / walnut gloss / Nuß glanz



karbon sijaj / karbon sjaj / carbon gloss / Karbon glanz

Program elementov / Program elemenata / Bathroom furniture / Typenübersicht

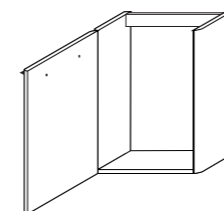

F 35.02 L,D
Element pod umivalnikom
Element ispod umivaonika
Vanity cabinet
Waschbeckenunterschrank
• 35/40/33
116,81 PT *

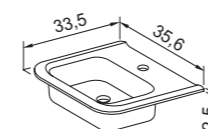

UM 35.183
Umivalnik
Umivaonik
Basin
Waschbecken
92,13 PT *



SKG 35.03
Ogledalo 35x75 cm s svetilko
Ogledalo 35x75 cm sa svjetiljkom
Mirror 35x75 cm with light fitting
Spiegel 35x75 cm mit leuchte
• 35/75/2
95,87 PT *

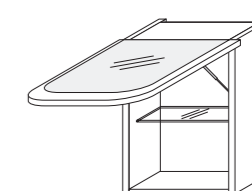

F 35.03
Viseči element z ogledalom
Viseči element s ogledalom
Wall-mounted mirror cabinet
Spiegelschrank
• 35/40/16
80,30 PT *

* Cena v točkah / Cijena u točkama / Price in points / Preis in Punkten

* Cena v točkah / Cijena u točkama / Price in points / Preis in Punkten

OASIS

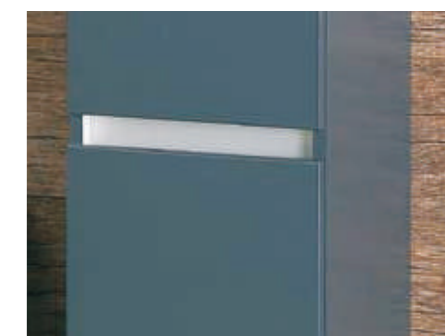
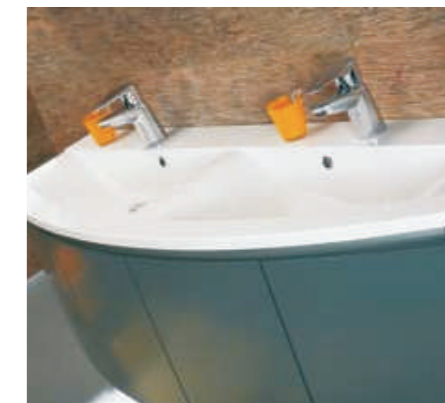

◀ Kopalniško pohištvo:
• Vrata: antracit
• Obod: antracit
Barva sanitarne opreme:
• DOLOPOL BISER

Namještaj za kupaonico:
• Vrata: antracit
• Obod: antracit
Boja sanitarne opreme:
• DOLOPOL BISER

Bathroom cabinets:
• Door: anthracite
• Body: anthracite
Sanitary ware colour:
• DOLOPOL BISER

Badezimmermöbel:
• Front: Anthrazit
• Korpus: Anthrazit
Farbe der Sanitäreinrichtung:
• DOLOPOL BISER

OASIS



Vrata: bela
Obod: teak

Door: white
Body: teak

Front: Weiß
Korpus: Teak

Harmonija med zaobljenostjo oblik in uporabnostjo notranjosti elementov. Predali so opremljeni s kakovostnimi vodili s polnim izvlekom in mehkim zapiranjem.

Harmonija zaobljenosti oblik i upotrebljivosti unutrašnjosti elemenata. ladice su opremljene kvalitetnim vodilicama na puno izvlačenje i mekim zatvaranjem.

A symphony of rounded edges and furniture functionality. Drawers feature quality pull-out telescopic sliding rails and soft closing.

Harmonie zwischen Abrundung der Formen und Nutzung der Innenflächen der Elemente. Dazu beitragen auch die Auszüge und Schubkasten mit dem Vollauszug und Weichschließen.



Odlika kopalnice Oasis so zaobljene linije, ki se popolnoma skladajo s sodobnostjo aluminija in gladkimi vrati brez ročajev.

Odlika kupaonice Oasis jesu zaobljene linije koje su u potpunom skladu sa suvremenošću aluminija i glatkim vratima bez ručki.

Oasis is characterised by soft lines, trendy aluminium, and handle- and knob-free doors.

Die Stärke des Badezimmers Oasis sind die abgerundeten Formen, die im vollen Einklang mit dem modern gestalteten Aluminium und den geraden Türen ohne grif sind.



▲ Vrata in obod: bela

Vrata i obod: bijela

Door and body: white

Front in Korpus: Weiß

OASIS



▲
Vrata: bela
Obod: teak

Vrata: bijela
Obod: teak

Door: white
Body: teak

Front: Weiß
Korpus: Teak



▲
Vrata in obod: antracit
Vrata i obod: antracit
Door and body: anthracite
Front und Korpus: Anthrazit



◀
Dvojni umivalnik
Dvostruki umivaonik
Double basin
Doppelwaschbecken

OASIS

Vrata / Vrata
Door / Front

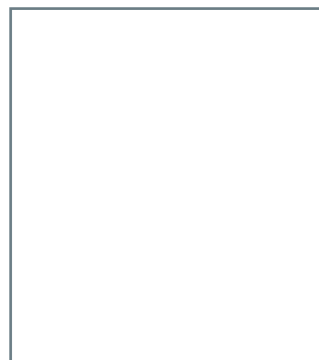

bela / bijela / white / Weiß

Vrata / Vrata / Door / Front:

- vlaknena plošča (MDF), lakirana z belim mat lakom
- vlaknatica (MDF), lakirana bijelim mat lakom

Vrata / Vrata
Door / Front



antracit/antracit/anthracite/Anthrazit

Vrata / Vrata / Door / Front:

- vlaknena plošča (MDF), lakirana z mat lakom v antracit barvi
- vlaknatica (MDF), lakirana mat lakom u antracit boji
- varnished fibreboard (MDF), antracite satin finish
- Faserplatte (MDF), Mattlack, Anthrazit

Obod / Obod / Body / Korpus

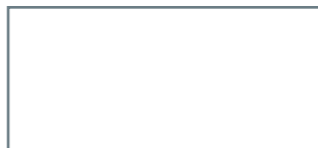

- varnished fibreboard (MDF), white satin finish
- Faserplatte (MDF), Mattlack, Weiß

Obod / Obod / Body / Korpus



antracit / antracit / anthracite / Anthrazit

Obod / Obod / Body / Korpus:

- bela oplemenitena iverna plošča, zunanje stene lakirane z mat lakom v antracit barvi
- bijela oplemenjena iverica, vanjske stranice lakirane mat lakom u antracit boji
- white laminated particle board, external panels coated in satin anthracite finish
- Kunststoffoberfläche Weiß, Außenwände Mattlack, Anthrazit



antracit / antracit / anthracite / Anthrazit



teak / teak / teak / Teak

Obod / Obod / Door / Korpus:

- bela oplemenitena iverna plošča, zunanje stene lakirane z mat lakom v beli ali antracit barvi



▲ Vrata so brez ročajev – v obod integrirana aluminijasta letev

Vrata su bez ručki – u obod integrirana aluminijaska letva

Handle- and knob-free doors with aluminium rail integrated into the body

Tür ohne grif – im Korpus integrierte Aluminiumleiste

- oplemenitena iverna plošča v dekorju tika
- bijela oplemenjena iverica, vanjske stranice lakirane mat lakom u bijeloj ili antracit boji
- oplemenjena iverica u dekoru tika
- white laminated particle board, external panels coated in satin white or anthracite finish
- laminated particle board in teak effect finish
- Kunststoffoberfläche, Außenwände lackiert mit Mattlack Weiß oder Anthrazit
- Kunststoffoberfläche in Holzstruktur Teak

OASIS

Program elementov / Program elemenata / Bathroom furniture / Typenübersicht

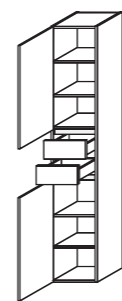

E 30.04 L,D
Visoka omara I,D
Visoki omar I,D
Tall cabinet I,R
Hochschrank I,R
• 30/180/35
296,43 PT *

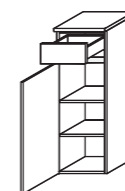

BKG 30.17 L,D
Spodnji element s pokrovno ploščo I,D
Donji element s pokrovnom pločom I,D
Base cabinet with top I,R
Unterschrank mit Deckplatte I,R
• 30/91,6/35
193,78 PT *

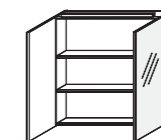

F 70.40
Viseći element z ogledali in svetilko
Viseći element s ogledalima i svjetiljkom
Wall-mounted mirror cabinet with light fitting
Spiegelschrank mit leuchte
• 70/70/18,4
217,21 PT *



F 105.40 L,D
Viseći element z ogledali in svetilko L,D
Viseći element s ogledalima i svjetiljkom L,D
Wall-mounted mirror cabinet with light fitting L,R
Spiegelschrank mit leuchte L,R
• 105/70+8,5/18,4
296,39 PT *

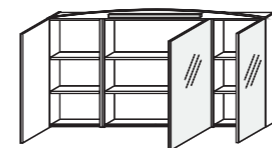

F 140.04
Viseći element z ogledali in svetilko
Viseći element s ogledalima i svjetiljkom
Wall-mounted mirror cabinet with light fitting
Spiegelschrank mit leuchte
• 140/70+8,5/18,4
347,32 PT *



Ogledalo 70x70cm s svetilko
Ogledalo 70 x70 cm sa svjetiljkom
Mirror 70x70 cm with light fitting
Spiegel 70x70 cm mit leuchte
• 70/70/2
113,63 PT *

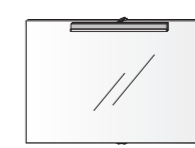

Ogledalo 105x70cm s svetilko
Ogledalo 105 x70 cm sa svjetiljkom
Mirror 105x70 cm with light fitting
Spiegel 105 x70 cm mit leuchte
• 105/70/2
127,17 PT *

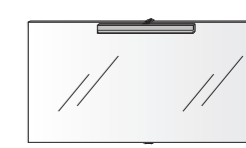

Ogledalo 140x70cm s svetilko
Ogledalo 140 x70 cm sa svjetiljkom
Mirror 140x70 cm with light fitting
Spiegel 140x70 cm mit leuchte
• 140/70/2
141,56 PT *



Staklena polica 60 cm
Staklena polica 60 cm
glass shelf 60 cm
glasablage 60 cm
• 60/0,8/15
12,48 PT *



Staklena polica 90 cm
Staklena polica 90 cm
glass shelf 90 cm
glasablage 90 cm
• 90/0,8/15
14,55 PT *

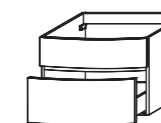

F 70.30
Element pod umivalnikom za umivalnik UM 70.118 / Element pod umivalnikom za umivalnik UM 70.118 / Basin vanity unit UM 70.118 / Waschbeckenunterschrank für Waschbecken UM 70.118
• 70/50/49,5
290,79 PT *

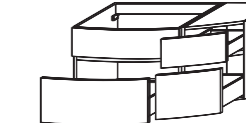

F 105.30 L,D
Element pod umivalnikom za umivalnik UM 105.118 L ali UM 105.118 D / Element ispod umivaonika za umivaonik UM 105.118 L ili UM 105.118 D / Basin vanity unit UM 105.118L or UM 105.118 R / Waschbeckenunterschrank für Waschbecken UM 105.118 L oder UM 105.118 R
• 105/50/49,5 (35)
494,75 PT *

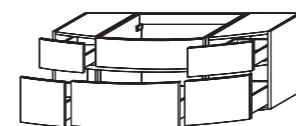

F 140.13
Element pod umivalnikom za umivalnik UM 140.118 (5 predalov)
Element ispod umivaonika za umivaonik UM 140.118 (5 ladica)
Basin vanity unit UM 140.118 (5 drawers)
Waschbeckenunterschrank für Waschbecken UM 140.118 (5 Schubladen)
• 140/50/49,5(35)
696,35 PT *

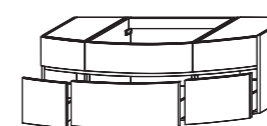

F 140.03
Element pod umivalnikom za umivalnik UM 140.118 (3 predali)
Element ispod umivaonika za umivaonik UM 140.118 (3 ladice)
Basin vanity unit UM 140.118 (3 drawers)
Waschbeckenunterschrank für Waschbecken UM 140.118 (3 Schubladen)
• 140/50/49,5(35)
610,29 PT *

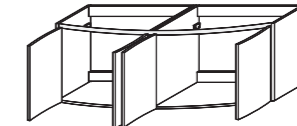

F 140.05
Element pod umivalnikom za umivalnik UM 140.119
Element ispod umivaonika za dvostruki umivaonik UM 140.119
Double basin vanity unit UM 140.119
Waschbeckenunterschrank für Doppelwaschbecken UMI40.119
• 140/50/49,5(35)
434,03 PT *

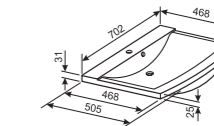

UM 70.118
Umivalnik
Umivaonik
Basin
Waschbecken
116,08 PT *

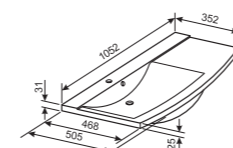

UM 105.118 L
Umivalnik, levi
Umivaonik, lijevi
Basin, left
Waschbecken, links
128,98 PT *

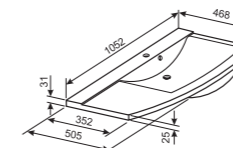

UM 105.118 D
Umivalnik, desni
Umivaonik, desni
Basin, right
Waschbecken, rechst
128,98 PT *

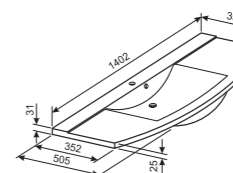

UM 140.118
Umivalnik
Umivaonik
Basin
Waschbecken
152,45 PT *

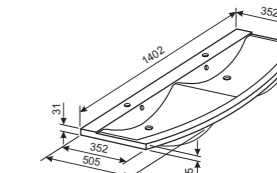

UM 140.119
Umivalnik, dvojni
Umivaonik, dvostruki
Basin, double
Waschbecken, doppelt
175,68 PT *

* Cena v točkah / Cijena u točkama / Price in points / Preis in Punkten

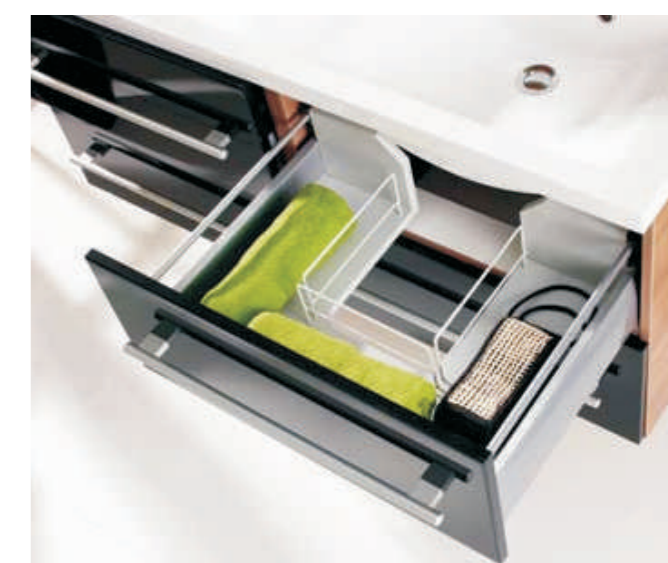

- ◀ Kopalniško pohištvo:
- Vrata: črna visok sijaj
 - Obod: oreh svetli
 - Ročaj: 90.Cr/mat
- Barva sanitarne opreme:
- DOLOPOL BISER
- Namještaj za kupaonice:
- Vrata: crna visoki sjaj
 - Obod: orah svijetli
 - Ručka: 90.Cr/mat
- Boja sanitarne opreme:
- DOLOPOL BISER
- Bathroom cabinets:
- Door: black high gloss
 - Body: walnut light
 - Handle: 90.Cr/satin
- Sanitary ware colour:
- DOLOPOL BISER
- Badezimmermöbel:
- Front: Schwarz Hochglanz
 - Korpus: Nuß hell
 - grif: 90.Cr/Matt
- Farbe der Sanitäreinrichtung:
- DOLOPOL BISER

AVON



Predali so opremljeni s kakovostnimi vodili s polnim izvlekom in mehkim zapiranjem.
 ladice su opremljene kvalitetnim vodilicama s potpunim izvlačenjem i mekim zatvaranjem.
 The drawers are fitted with superior quality, full-extension, soft close guides.
 Die Schubkasten zeichnen sich durch den vollen Auszug und den Softeinzug aus.

▲
 Vrata: jabolčno zelena visok sijaj
 Obod: wenge

Vrata : jabolčno zelena visoki sjaj
 Obod: wenge

Door: apple green, high gloss
 Body: wenge

Front: Apfelgrün, Hochglanz
 Korpus: Wenge



▲
 Vrata: bela visok sijaj
 Obod: oreh svetli
 Vrata: bijela visoki sjaj
 Obod: orah svijetli
 Door: white high gloss
 Body: walnut light
 Front: Weiß
 Hochglanz
 Korpus: Nuß hell



▶
 Vrata: bela visok sijaj
 Obod: bela sijaj
 Vrata: bijela visoki sjaj
 Obod: bijela sjaj
 Door: white high gloss
 Body: white gloss
 Front: Weiß Hochglanz
 Korpus: Weiß Glanz



AVON



▲
 Vrata: črna visok sijaj, Obod: bel sijaj
 Vrata: crna visoki sjaj, Obod: bijeli sijaj
 Door: black high gloss, Body: white gloss
 Front: Schwarz Hochglanz, Korpus: Weiß Glanz



▲
 Vrata: bordo rdeča visok sijaj,
 Obod: wenge
 Vrata: bordo crvena visoki sjaj,
 Obod: wenge
 Door: Bordeaux red high gloss
 Body: wenge
 Front: Bordeaux rot Hochglanz
 Korpus: Wenge



▲
 Vrata: vanilija visok sijaj
 Obod: wenge
 Vrata: vanilija visoki sjaj,
 Obod: wenge
 Door: vanilla high gloss
 Body: wenge
 Front: Vanille Hochglanz
 Korpus: Wenge

AVON

Vrata / Vrata / Doors / Frontvarianten



bela sijaj / bijela sjaj / white gloss / Weiß Glanz
vanilija sijaj / vanilija sjaj / vanilla gloss / Vanille Glanz
bordo rdeča sijaj / bordo crvena sjaj / bordeaux red gloss / Bordeaux rot Glanz
črna sijaj / crna sjaj / black gloss / Schwarz Glanz
jabolčno zelena sijaj / jabolčno zelena sjaj / apple green gloss / Apfelgrün Glanz
oreh svetli, sijaj / orah svijetli, sjaj / walnut light, gloss / Nuß hell, Glanz

Vrata:

- oplašćena vlaknena (MDF) plošča v visokem sijaju: bela, vanilija, bordo rdeča, črna
- vlaknena plošča (MDF), lakirana z visokosijajnim lakom: jabolčno zelena
- oplemenitena iverna plošča v strukturi orehovega lesa: orah svetli, visok sijaj

Vrata:

- obložena vlaknatica (MDF) u visokome sjaju: bijela, vanilija, bordo crvena, crna
- vlaknatica (MDF), lakirana visokosijajnim lakom: jabolčno zelena
- oplemenjena iverica u strukturi orahovog drveta: orah svijetli, visoki sjaj

Door:

- foiled fibreboard (MDF) with high-gloss finish: white, vanilla, bordeaux red, black
- fibreboard (MDF) coated with high-gloss lacquer: apple green
- laminated particle board in wood texture: walnut light, high gloss

Front:

- Faserplatte (MDF) Hochglanz foliert: Weiß, Vanille, Bordeaux rot, Schwarz
- Faserplatte (MDF), lackiert mit Hochglanzlack: Apfelgrün
- Kunststoffoberfläche in Holzstruktur Nuß hell, Hochglanz

Obod / Obod / Cabinet body / Korpus



bela sijaj / bijela sijaj / white gloss / Weiß Glanz
oreh svetli / orah svijetli / walnut light / Nuß hell
wenge furnir / wenge furnir / wenge veneer / Wenge Furnier

Umivalnik po meri omogoča individualno določitev širine umivalnika v razponu od 90 do 210 cm.

Umivaonik po mjeri omogućava individualno određivanje širine umivaonika u rasponu od 90 do 210 cm.

The made-to-measure basin allows for individual choices of width between 90 and 210 cm.

Waschbecken nach Maß ermöglicht individuelle Einstellung der Waschbeckenbreite von 90 bis 210 cm.

Obod:

- bela sijajna oplemenitena iverna plošča
- oplemenitena iverna plošča v strukturi svetlega orehovega lesa
- furnirana iverna plošča: lužen hrast wenge

Obod:

- bijela sijajna oplemenjena iverica
- oplemenjena iverica u strukturi svijetlog orahovog drveta
- furnirana iverica: luženi hrast wenge

Body:

- white gloss laminated particle board
- laminated particle board in light walnut wood structure
- particle board oak veneered and wenge varnished

Korpus:

- Kunststoffoberfläche Weiß Glanz
- Kunststoffoberfläche Nuß hell
- furnierte Spanplatte: gelaugte Eiche wenge

AVON

Program elementov / Program elemenata / Bathroom furniture / Typenübersicht

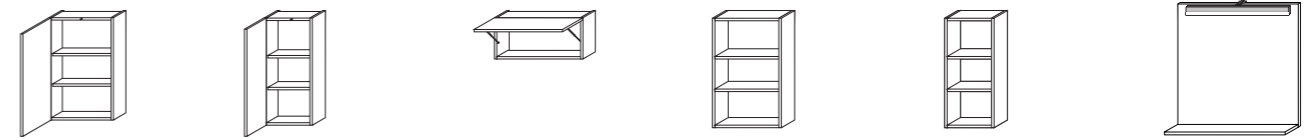

B 45.07 L,D / Viseći element L,D / Wall cabinet L,R / Wandschrank L,R • 45/75/20 / 101,59 PT *
B 30.07 L,D / Viseći element L,D / Wall cabinet L,R / Wandschrank L,R • 30/75/20 / 85,59 PT *
B 60.01 / Viseći element / Viseći element / Wall cabinet / Wandschrank • 60/30/20 / 100,35 PT *
F 45.02 / Viseći element s policama / Viseći element s policama / Wall cabinet with shelves / Wandelement mit Ablagen • 45/75/18 / 71,29 PT *
F 30.02 / Viseći element s policama / Viseći element s policama / Wall cabinet with shelves / Wandelement mit Ablagen • 30/75/18 / 62,08 PT *
SKG 60.03 / Ogledalo s policom i svetilko / Ogledalo s policom i svetilkom / Mirror with shelf and lamp / Spiegel mit Ablage und leuchte • 60/75/15,3 / 180,12 PT *

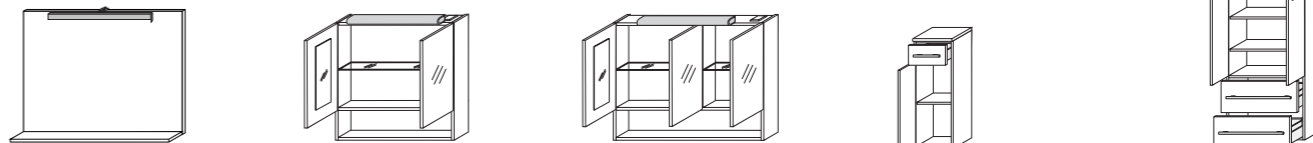

SKG 90.03 / Ogledalo s policom i svetilko / Ogledalo s policom i svetilkom / Mirror with shelf and lamp / Spiegel mit Ablage und leuchte • 90/75/15,3 / 194,47 PT *
F 60.02 / Element z ogledali i svetilko / Element z ogledalima i svetilkom / Wall cabinet with mirrors and lamp / Spiegelschrank mit leuchte • 60/75/20 / 234,96 PT *
F 90.22 / Element z ogledali i svetilko / Element z ogledalima i svetilkom / Wall cabinet with mirrors and lamp / Spiegelschrank mit leuchte • 90/75/20 / 271,06 PT *
BKG 30.16 L,D / Spodnji element s pokrovno ploščo L,D / Donji element s pokrovnom pločom L,D / Base cabinet with functional top L,R / Unterschrank mit Deckplatte L,R • 30,2/91,6/36 / 175,72 PT *
BKG 60.18 / Visoka omara s pokrovno ploščo / Visoka omara s pokrovnom pločom / Tall cabinet with functional top / Hochschrank mit Deckplatte • 60,2/126,6/36 / 362,12 PT *

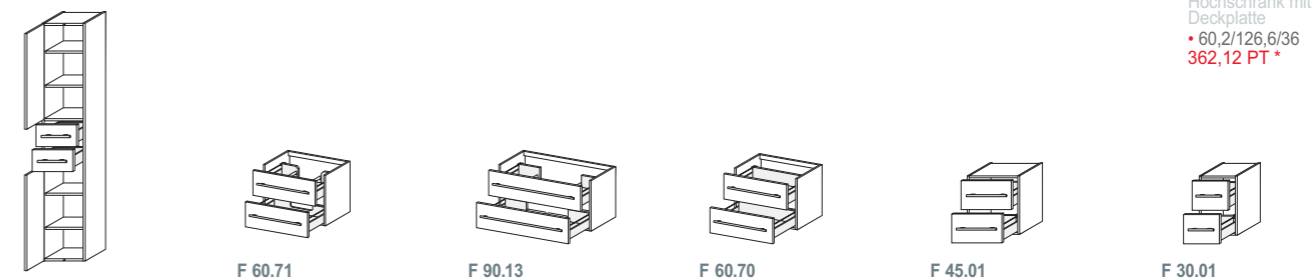

E 30.02 L,D / Visoka omara L,D / Tall cabinet L,R / Hochschrank L,R • 30/180/35 / 307,03 PT *
F 60.71 / Element pod umivalnikom / Element ispod umivaonika / Vanity cabinet / Waschbeckenunterschrank • 60/50/45 / 211,77 PT *
F 90.13 / Element pod umivalnikom / Element ispod umivaonika / Vanity cabinet / Waschbeckenunterschrank • 90/50/45 / 283,10 PT *
F 60.70 / Spodnji element / Donji element / Base cabinet / Unterschrank • 60/50/45 / 233,22 PT *
F 45.01 / Spodnji element / Donji element / Base cabinet / Unterschrank • 45/50/45 / 225,25 PT *
F 30.01 / Spodnji element / Donji element / Base cabinet / Unterschrank • 30/50/45 / 196,08 PT *

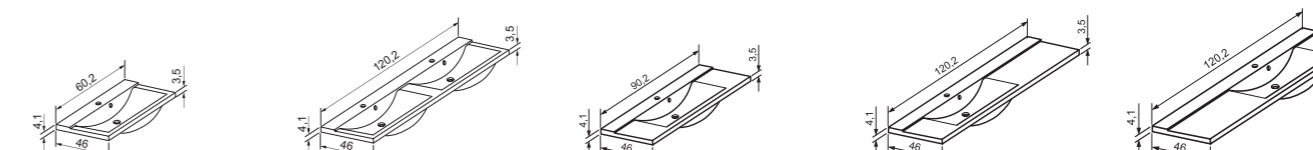

UM 60.181 / Umivalnik / Umivaonik / Basin / Waschbecken • 102,45 PT *
UM 120.182 / Umivalnik, dvojni / Umivaonik, dvostruki / Basin, double / Waschbecken, doppelt • 164,21 PT *
UM 90.104 / Umivalnik / Umivaonik / Basin / Waschbecken • 126,65 PT *
UM 120.104 L / Umivalnik, levi / Umivaonik, lijevi / Basin, left / Waschbecken, links • 143,71 PT *
UM 120.104 D / Umivalnik, desni / Umivaonik, desni / Basin, right / Waschbecken, rechts • 143,71 PT *

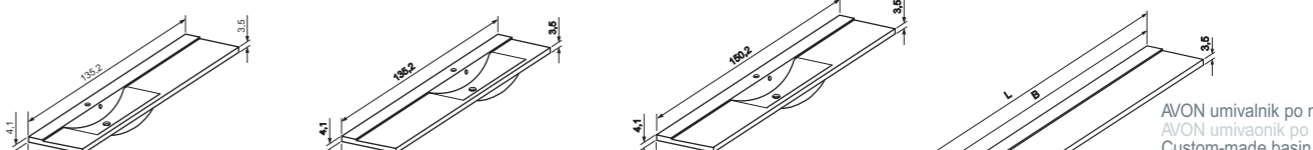

UM 135.104 L / Umivalnik, levi / Umivaonik, lijevi / Basin, left / Waschbecken, links • 151,07 PT *
UM 135.104 D / Umivalnik, desni / Umivaonik, desni / Basin, right / Waschbecken, rechts • 151,07 PT *
UM 150.104 / Umivalnik / Umivaonik / Basin / Waschbecken • 158,88 PT *
AVON umivalnik po meri / AVON umivaonik po mjeri / Custom-made basin AVON / AVON Waschbecken nach Maß / L = min 90 – max 210 cm / UM 109.109 / UM 129.109 / UM 159.109 / UM 189.109 / UM 210.109 • 261,33 - 312,72 PT *

* Cena v točkah / Cijena u točkama / Price in points / Preis in Punkten

SLIM



Globina umivalnika SLIM je samo 36 cm!
Odlično za majhne kopalnice.

Dubina umivaonika SLIM iznosi samo 36
cm! Odlično za male kupaonice.

The depth of the SLIM basin is only 36 cm!
Excellent for small bathrooms.

Das Waschbecken SLIM ist nur 36 cm tief!
Hervorragend für kleine Badezimmer.



◀ Kopalniško pohištvo:

- Vrata: bela visok sijaj
- Obod: oreh temni
- Ročaj: 105.Ni

Barva sanitarne opreme:

- DOIOPOI BISER

Namještaj za kupaonice:

- Vrata: bela visok sijaj
- Obod: orah tamni
- Ručka: 105.Ni

Boja sanitarne opreme:

- DOIOPOI BISER

Bathroom cabinets:

- Door: white high gloss
- Body: walnut dark
- Handle: 105.Ni

Sanitary ware colour:

- DOIOPOI BISER

Badezimmermöbel:

- Front: Weiß Hochglanz
- Korpus: Nuß dunkel
- grif: 105.Ni

Farbe der Sanitäreinrichtung:

- DOIOPOI BISER

SLIM



SLIM

Program elementov / Program elemenata / Bathroom furniture / Typenübersicht

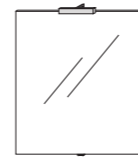

Ogledalo 60x80 cm s svetilko
Ogledalo 60x80 cm sa svjetiljkom
Mirror 60x80 cm with light fitting
Spiegel 60x80 mit leuchte
• 60/80/2
80,81 PT *

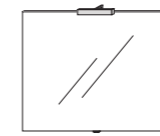

Ogledalo 80x60 cm s svetilko
Ogledalo 80x60 cm sa svjetiljkom
Mirror 80x60 cm with light fitting
Spiegel 80x60 mit leuchte
• 80/60/2
80,73 PT *

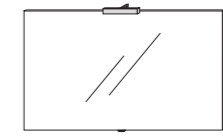

Ogledalo 100x60 cm s svetilko
Ogledalo 100x60 cm sa svjetiljkom
Mirror 100x60 cm with light fitting
Spiegel 100x60 mit leuchte
• 100/60/2
86,80 PT *

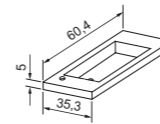

UM 60.120
Umivalnik
Umivaonik
Basin
Waschbecken
60,4/5 /35,3
120,73 PT *

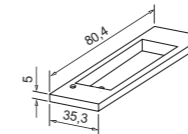

UM 80.120
Umivalnik
Umivaonik
Basin
Waschbecken
80,4/5/35,3
131,68 PT *

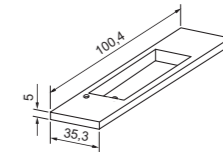

UM 100.120
Umivalnik
Umivaonik
Basin
Waschbecken
100,4/5/35,3
140,15 PT *

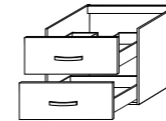

F 60.05
Element pod umivalnikom
Element ispod umivaonika
Vanity cabinet
Waschbeckenunterschrank
60/50/35
229,00 PT *

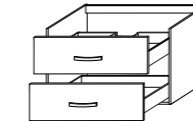

F 80.05
Element pod umivalnikom
Element ispod umivaonika
Vanity cabinet
Waschbeckenunterschrank
80/50/35
243,01 PT *

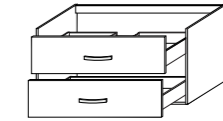

F 100.05
Element pod umivalnikom
Element ispod umivaonika
Vanity cabinet
Waschbeckenunterschrank
100/50/35
257,42 PT *

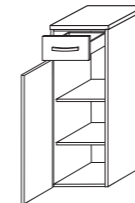

BKG 30.16 L,D
Spodnji element s pokrivo ploščo L,D
Donji element s pokrivnom pločom L,D
Base cabinet with functional top L,R
Unterschrank mit Deckplatte L,R
• 30,2/91,6/36
143,81 PT *

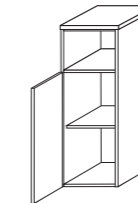

BKG 30.19 L,D
Spodnji element s pokrivo ploščo L,D
Donji element s pokrivnom pločom L,D
Base cabinet with functional top L,R
Unterschrank mit Deckplatte L,R
• 30,2/91,6/36
61,03 PT *

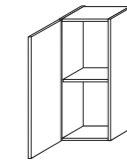

B 30.01 L,D
Viseći element L,D
Viseći element L,D
Wall cabinet L,R
Wandschrank L,R
• 30/60/20
36,92 PT *

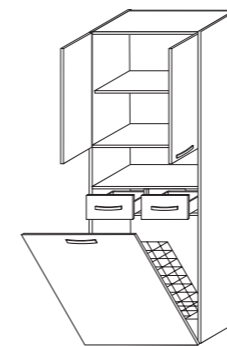

E 60.63
Visoka omara
Visoki ormar
Tall cabinet
Hochschrank
• 60/180/35
375,23 PT *

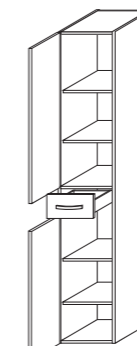

E 30.06 L,D
Visoka omara L,D
Visoki ormar L,D
Tall cabinet L,R
Hochschrank L,R
• 30/180/35
253,43 PT *

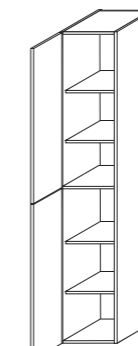

E 30.05 L,D
Visoka omara L,D
Visoki ormar L,D
Tall cabinet L,R
Hochschrank L,R
• 30/180/35
185,87 PT *

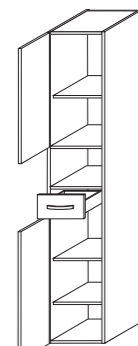

E 30.63 L,D
Visoka omara L,D
Visoki ormar L,D
Tall cabinet L,R
Hochschrank L,R
• 30/180/35
225,05 PT *

Vrata / Vrata / Door / Front

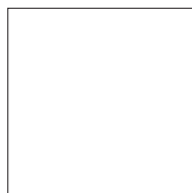

bela visok sijaj
bijela sjaj
white gloss
Weiß glanz

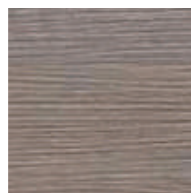

hrast antracit
hrast antracit
oak anthracite
Eiche Anthrazit

- Vrata:
- oplasčena vlaknena plošča (MDF) v visokem sijaju: bela
 - oplemenitena iverna plošča: hrast antracit

- Vrata:
- obložena vlaknatica (MDF) u visokome sjaju: bijela
 - oplemenjena iverica: hrast antracit

- Door:
- foiled fibreboard (MDF) with high-gloss finish: white
 - laminated particle board: oak anthracite

- Front:
- Faserplatte (MDF) Hochglanz foliert: Weiß
 - Kunststoffoberfläche: Eiche Anthrazit

Obod / Obod / Body / Korpus



bela sijaj
bijela sjaj
white gloss
Weiß glanz

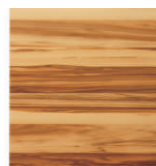

karibski oreh
karibski oreh
caribbean walnut
karibisch Nuss

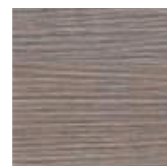

hrast antracit
hrast antracit
oak anthracite
Eiche Anthrazit

- Obod:
- oplemenitena iverna plošča: bela sijaj, karibski oreh, hrast antracit

- Obod:
- oplemenjena iverica: bijela sjaj, karibski oreh, hrast antracit

- Body:
- laminated particle board: white gloss, caribbean walnut, oak anthracite

- Korpus:
- Kunststoffoberfläche: Weiß glanz, karibisch Nuss, Eiche Anthrazit

Vrata / Vrata / Door / Front

bela sijaj
bijela sjaj
white gloss
Weiß glanz

hrast antracit
hrast antracit
oak anthracite
Eiche Anthrazit



Obod / Obod / Body / Korpus

bela sijaj
bijela sjaj
white gloss
Weiß glanz

hrast antracit
hrast antracit
oak anthracite
Eiche Anthrazit

karibski oreh
karibski oreh
caribbean walnut
karibisch Nuss

JULIJA



- Sanitarna oprema:
 - DOLOPOL BISER
- Sanitarna oprema:
 - DOLOPOL BISER
- Sanitary ware:
 - DOLOPOL BISER
- Sanitäreinrichtung:
 - DOLOPOL BISER



JULIJA



Program elementov / Program elemenata / Bathroom furniture / Typenübersicht



SKG 35.03
Ogledalo 35x75 cm s svetilko
Ogledalo 35x75 cm sa svetiljkom
Mirror 35x75 cm with light fitting
Spiegel 35x75 cm mit leuchte
• 35/75/2
95,87 PT *

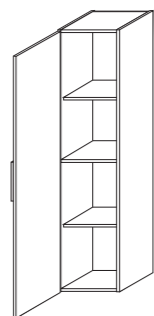

D 35.07 L,D
Visoka omara L,D
Visoki ormar L,D
Tall cabinet L,R
Hochschrank L,R
• 35/130/30
113,22 PT *

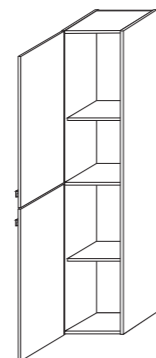

E 35.07 L,D
Visoka omara I,D
Visoki ormar I,D
Tall cabinet I,R
Hochschrank I,R
• 35/160/35
149,59 PT *

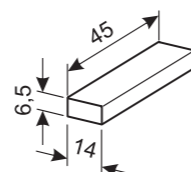

PL 45.185
Polica Julija
Polica Julija
Shelf Julija
Ablage Julija
• 45/6,5/14
65,32 PT *

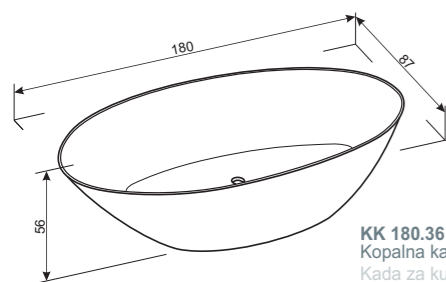

KK 180.36
Kopalna kad Julija
Kada za kupanje Julija
Bathtub Julija
Badewanne Julija
• 180/56/87
1.095,32 PT *

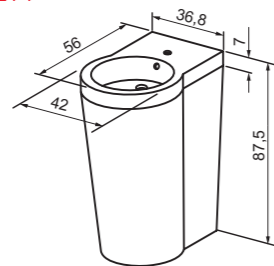

UM 42.185
Umivalnik Julija
Umivaonik Julija
Basin Julija
Waschbecken Julija
• 42/87,5/56
263,08 PT *

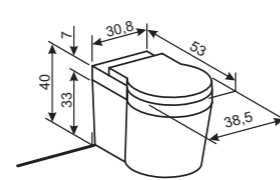

WC 39.27
WC školjka Julija
WC školjka Julija
Toilet bowl Julija
Toilettenschüssel Julija
• 38,5/43,5/53
531,76 PT *

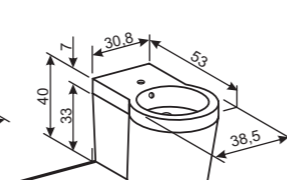

BD 39.27
Bide Julija
Bide Julija
Bidet Julija
Bidet Julija
• 38,5/40/53
337,92 PT *

* Cena v točkah / Cijena u točkama / Price in points / Preis in Punkten

STANDARD

Fresh karisma	48
Catania	54
Quadra	56
Quadra+	60

Ljepota, ki prisega na večnost, ustvarja občutek domačnosti in prijetne topline. -

Ljepota koja premašuje vječnost, ostvaruje osjećaj do maće atmosfere i ugodne topline. -

The beauty relying on eternity creates a sense of homeliness and pleasant warmth.

Die ewige Schönheit bietet das Gefühl der Geborgenheit und angenehme Wärme.

FRESH KARISMA

Kopalniško pohištvo:

Vrata: oplemenitena iverna plošča, teak
 Obod: oplemenitena iverna plošča, teak
 Barva sanitarne opreme: DOLOPOL BISER
 Bathroom cabinets:
 Door: laminated particle board, teak
 Body: laminated particle board, teak
 Sanitary ware colour: DOLOPOL BISER

Namještaj za kupaonice:

Vrata: oplemenjena iverica, teak
 Obod: oplemenjena iverica, teak
 Boja sanitarne opreme: DOLOPOL BISER
 Badezimmermöbel:
 Front: Kunststoffoberfläche, Teak
 Korpus: Kunststoffoberfläche, Teak
 Farbe der Sanitäreinrichtung: DOLOPOL BISER



Doors and cabinet body: Cambara
 Front und Korpus: Cambara
 Façades et corps de meuble : Cambara



A highly original wash hand basin design rounds off the beauty and harmony of your Fresh bathroom.

Das originelles Design des Waschbeckens vervollständigt das harmonische Aussehen des Badezimmers Fresh.

Le design original de la vasque complète l'aspect harmonieux de la salle de bains Fresh.

Vrata: karibski oreh
 Obod: karibski oreh
 Door: Caribbean walnut
 Body: Caribbean walnut
 Vrata: karibski oreh
 Obod: karibski oreh
 Front: karibsch Nuss
 Korpus: karibsch Nuss



Drawers feature superior, full extension slides and soft closing.

Durch hochwertige Teleskopführungen lassen sich die Schubladen voll ausziehen und sanft schließen.

Les tiroirs sont dotés de coulisses de qualité à sortie totale et à fermeture douce.

Doors and cabinet body: white, high gloss
 Front und Korpus: Weiß Hochglanz lackiert
 Façades et corps de meuble : blanc, ultra brillant



FRESH KARISMA

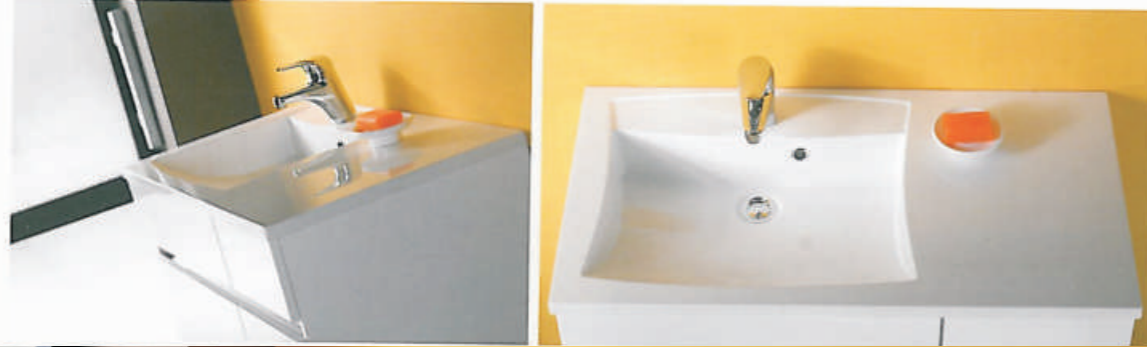

Kopalniško pohištvo:
 Vrata: oplemenitena iverna plošča, teak
 Obod: oplemenitena iverna plošča, teak
 Barva sanitarne opreme: DOLOPOL BISER
 Bathroom cabinets:
 Door: laminated particle board, teak
 Body: laminated particle board, teak
 Sanitary ware colour: DOLOPOL BISER

Namještaj za kupaonice:
 Vrata: oplemenjena iverica, teak
 Obod: oplemenjena iverica, teak
 Boja sanitarne opreme: DOLOPOL BISER
 Badezimmermöbel:
 Front: Kunststofoberfläche, Teak
 Korpus: Kunststofoberfläche, Teak
 Farbe der Sanitäreinrichtung: DOLOPOL BISER



Doors and cabinet body: white, high gloss
 Front und Korpus: Weiß Hochglanz lackiert
 Façades et corps de meuble : blanc, ultra brillant



Doors and cabinet body: white, high gloss
 Front und Korpus: Weiß Hochglanz lackiert
 Façades et corps de meuble : blanc, ultra brillant

FRESH KARISMA

Doors and cabinet body/Front und Korpus/Façades et corps de meuble

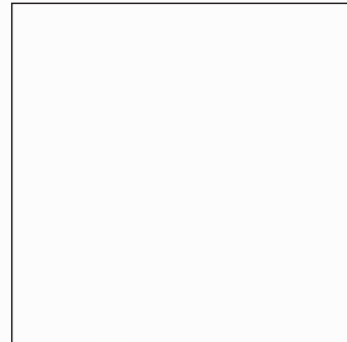

White/Weiss/Blanc

Doors/Tür/Façade:

- foiled fibreboard (MDF) with high gloss finish
- Faserplatte (MDF) Hochglanz foliert
- panneau de fibres revêtu (MDF), finition ultra brillante

Cabinet body/Korpus/Corps de meuble:

- white laminated particle board, high gloss varnish (exterior surfaces only)
- Kunststoffoberfläche weiss, die Außenflächen Hochglanz lackiert
- panneau de particules laminé blanc, surfaces extérieures finition laquée ultra brillante

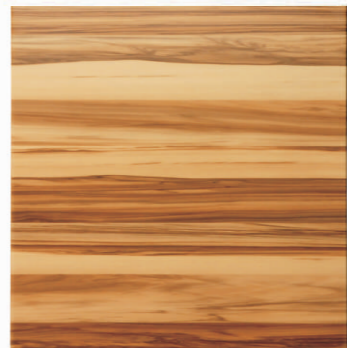

karibski oreh/Caribbean walnut/karibski orah/karibsch Nuss

Vrata: oplemenitena iverna plošča, karibski oreh
Obod: oplemenitena iverna plošča, karibski oreh

Door: laminated particle board, Caribbean walnut
Body: laminated particle board, Caribbean walnut

Vrata: oplemenjena iverica, karibski orah
Obod: oplemenjena iverica, karibski orah

Front: Kunststoffoberfläche, karibsch Nuss
Korpus: Kunststoffoberfläche, karibsch Nuss



teak/teak/teak/Teak

Vrata: oplemenitena iverna plošča, teak
Obod: oplemenitena iverna plošča, teak

Door: laminated particle board, teak
Body: laminated particle board, teak

Vrata: oplemenjena iverica, teak
Obod: oplemenjena iverica, teak

Front: Kunststoffoberfläche, Teak
Korpus: Kunststoffoberfläche, Teak

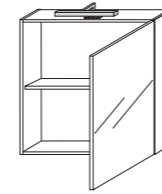

F 60.11 L/D
Element z ogledali
Element s ogledalima
Wall cabinet with mirrors
Spiegelschrank
• 60/60/20
147,75 PT *

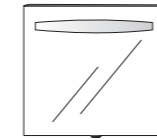

F 60.04
Ogledalo 60x60 cm z vgrajeno svetilko
Ogledalo 60x60 cm sa ugrađenom svjetiljkom
Mirror 60x60 cm with built-in light
Spiegel 60x60 mit eingebauter Leuchte
• 60/60/4,5
111,72 PT *

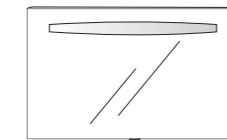

F 90.04
Ogledalo 90x60 cm z vgrajeno svetilko
Ogledalo 90x60 cm sa ugrađenom svjetiljkom
Mirror 90x60 cm with built-in light
Spiegel 90x60 mit eingebauter Leuchte
• 90/60/4,5
125,30 PT *

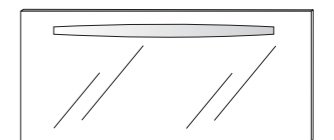

F 120.04
Ogledalo 120x60 cm z vgrajeno svetilko
Ogledalo 120x60 cm sa ugrađenom svjetiljkom
Mirror 120x60 cm with built-in light
Spiegel 120x60 mit eingebauter Leuchte
• 120/60/4,5
141,08 PT *

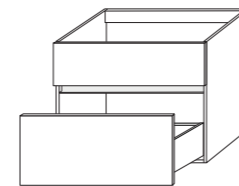

F 60.20
Element pod umivalnikom
Element ispod umivaonika
Vanity cabinet
Waschbeckenunterschrank
• 60/50/49,5
116,72 PT *

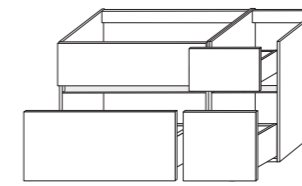

F 90.20 L,D
Element pod umivalnikom
Element ispod umivaonika
Vanity cabinet
Waschbeckenunterschrank
• 90/50/49,5
227,26 PT *

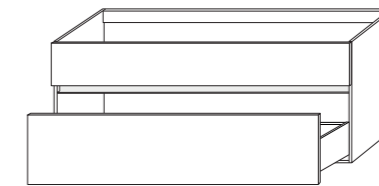

F 120.22
Element pod umivalnikom
Element ispod umivaonika
Vanity cabinet
Waschbeckenunterschrank
• 120/50/49,5
169,07 PT *

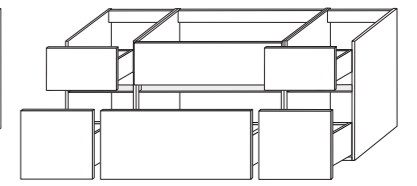

F 120.11
Element pod umivalnikom
Element ispod umivaonika
Vanity cabinet
Waschbeckenunterschrank
• 120/50/49,5
336,94 PT *

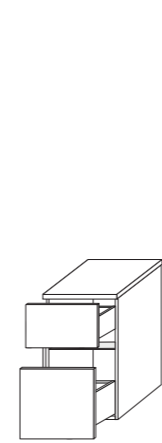

BKG 30.24 L/D
Spodnji element
Donji element
Base cabinet
Unterschrank
• 30,2/51,6/51
133,89 PT *

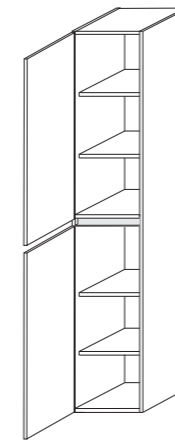

E 30.03 L,D
Visoka omara L,D
Visoki ormar L,D
Tall cabinet L,R
Hochschrank L,R
• 30/180/35
142,63 PT *

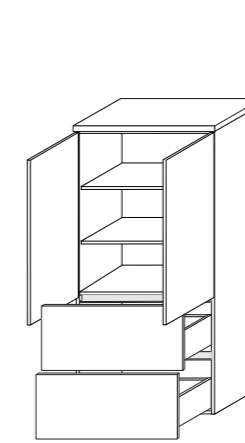

BKG 60.38
Visoka omara s pokrivno ploščo
Visoki ormar s pokrovnom pločom
Tall cabinet with functional top
Hochschrank mit Deckplatte
• 60,2/126,6/36
217,43 PT *

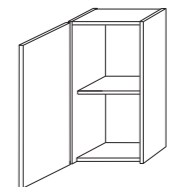

B 30.09 L,D
Viseći element L,D
Viseći element L,D
Wall cabinet L,R
Wandschrank L,R
• 30/60/20
47,31 PT *

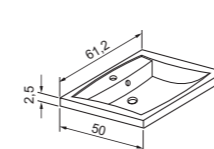

UM 61.110
Umivalnik
Umivaonik
Basin
Waschbecken
113,74 PT *

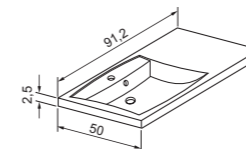

UM 91.110L
Umivalnik
Umivaonik
Basin
Waschbecken
129,35 PT *

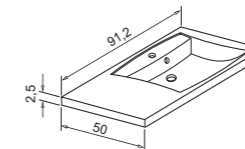

UM 91.110R
Umivalnik
Umivaonik
Basin
Waschbecken
129,35 PT *

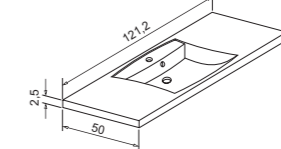

UM 121.110
Umivalnik
Umivaonik
Basin
Waschbecken
146,60 PT *

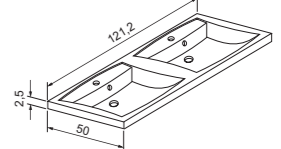

UM 121.111
Umivalnik
Umivaonik
Basin
Waschbecken
174,27 PT *

CATANIA



- BKG 125.03
- umivalnik 90 cm z nosilcem za brisače
 - element pod umivalnikom 90 cm (3 vrata)
 - spodnji element 35 cm (1 vrata, 2 predala)
 - zgornji element 35 cm (1 vrata)
 - zgornji element 20 cm (1 vrata)
 - ogledalo 70 cm
 - polica 70 cm s halogenskimi svetili, stikalom in vtičnico
 - segment ogledala 20 cm
 - umivaonik 90 cm s držačem ručnika
 - element ispod umivaonika 90 cm (3 vrata)
 - donji element 35 cm (1 vrata, 2 ladice)
 - gornji element 35 cm (1 vrata)
 - gornji element 20 cm (1 vrata)
 - ogledalo 70 cm
 - polica 70 cm s halogenskim svjetlima, prekidačem i utičnicom
 - segment ogledala 20 cm
 - 90 cm basin with towel rail
 - vanity cabinet (three doors), 90 cm
 - base cabinet (1 door, 2 drawers), 35 cm
 - wall cabinet (1 door), 35 cm
 - wall cabinet (1 door), 20 cm
 - mirror, 70 cm
 - shelf with halogen light fittings, switch and power outlet, 70 cm
 - mirror panel, 20 cm
 - Waschbecken 90 cm mit Handtuchhalter
 - Waschbeckenunterschrank 90 cm (3 Türen)
 - Unterschrank 35 cm (1 Tür, 2 Schubladen)
 - Wandschrank 35 cm (1 Tür)
 - Wandschrank 20 cm (1 Tür)
 - Spiegel 70 cm
 - Ablage 70 cm mit Halogenleuchten, Schalter und Stecker
 - Spiegelsegment 20 cm
- 576,29 PT ***

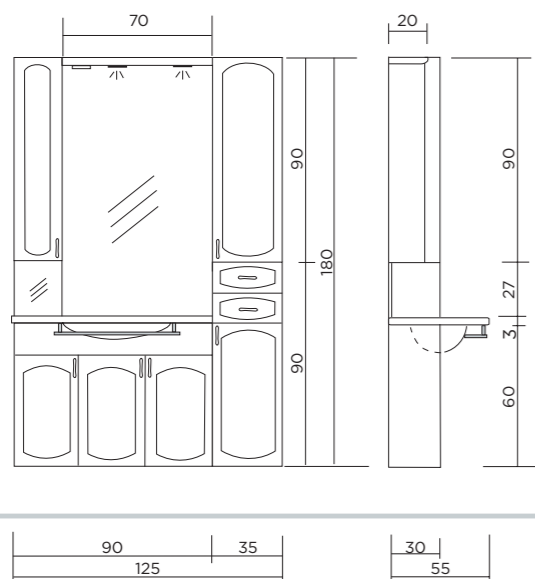

Vrata: oplaščena vlaknena plošča (MDF) v visokem sijaju: bela
 Obod: oplemenitena iverna plošča: bela sijaj
 Vrata: obložena vlaknatica (MDF) u visokome sjaju: bijela
 Obod: oplemenjena iverica: bijela sjaj
 Door: foiled fibreboard (MDF) with high-gloss finish: white
 Body: laminated particle board: white gloss
 Front: Faserplatte (MDF) Hochglanz foliert: Weiß
 Korpus: Kunststoffoberfläche: Weiß glanz

QUADRA



Vrata: oplasčena vlaknena plošča (MDF) v visokem sijaju: bela
Obod: oplemenitena iverna plošča: bela sijaj

Vrata: obložena vlaknatica (MDF) u visokom sjaju: bijela
Obod: oplemenjena iverica: bijela sjaj



Door: foiled fibreboard (MDF) with high-gloss finish: white
Body: laminated particle board: white gloss
Front: Faserplatte (MDF) Hochglanz foliert: Weiß
Korpus: Kunststoffoberfläche: Weiß glanz

QUADRA



Vrata: oplasčena vlaknena plošča (MDF) v visokem sijaju: bela
Obod: oplemenitena iverna plošča: bela sijaj

Vrata: obložena vlaknatica (MDF) u visokome sjaju: bijela
Obod: oplemenjena iverica: bijela sjaj

Door: foiled fibreboard (MDF) with high-gloss finish: white
Body: laminated particle board: white gloss

Front: Faserplatte (MDF) Hochglanz foliert: Weiß
Korpus: Kunststoffoberfläche: Weiß glanz

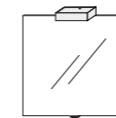

Ogledalo 60x60 cm s svetilko
Ogledalo 60x60 cm sa svjetiljkom
Mirror 60x60 cm with light fitting
Spiegel 60x60 cm mit leuchte
• 60/60/2
69,60 PT *

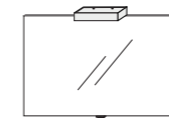

Ogledalo 90x60 cm s svetilko
Ogledalo 90x60 cm sa svjetiljkom
Mirror 90x60 cm with light fitting
Spiegel 90x60 cm mit leuchte
• 90/60/2
112,44 PT *



Ogledalo 60x90 cm s svetilko
Ogledalo 60x90 cm sa svjetiljkom
Mirror 60x90 cm with light fitting
Spiegel 60x90 cm mit leuchte
• 60/90/2
83,18 PT *

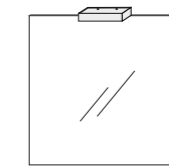

Ogledalo 90x90 cm s svetilko
Ogledalo 90x90 cm sa svjetiljkom
Mirror 90x90 cm with light fitting
Spiegel 90x90 cm mit leuchte
• 90/90/2
122,88 PT *

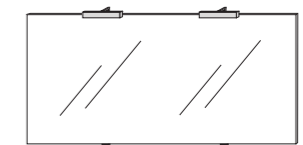

Ogledalo 120x60 cm s svetilko
Ogledalo 120x60 cm sa svjetiljkom
Mirror 120x60 cm with light fitting
Spiegel 120x60 cm mit leuchte
• 120/60/2
132,53 PT *

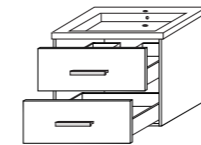

BKG 60.35
Umivalnik 60 cm
Umivaonik 60 cm
Basin 60 cm
Waschbecken 60 cm
• 60/5/46
Element pod umivalnikom 60 cm
Element ispod umivaonika 60 cm
Vanity cabinet 60 cm
Waschbeckenunterschrank 60 cm
• 60/50/45
243,47 PT *

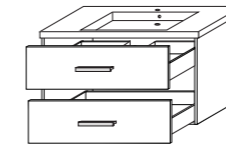

BKG 90.21
Umivalnik 90 cm
Umivaonik 90 cm
Basin 90 cm
Waschbecken 90 cm
• 90/5/46
Element pod umivalnikom 90 cm
Element ispod umivaonika 90 cm
Vanity cabinet 90 cm
Waschbeckenunterschrank 90 cm
• 90/50/45
285,46 PT *

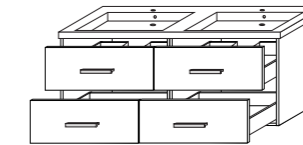

BKG 120.42
Umivalnik 120 cm
Umivaonik 120 cm
Basin 120 cm
Waschbecken 120 cm
• 120/5/46
Element pod umivalnikom 120 cm
Element ispod umivaonika 120 cm
Vanity cabinet 120 cm
Waschbeckenunterschrank 120 cm
• 120/50/45
439,75 PT *

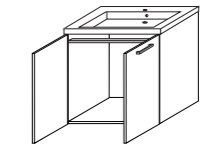

BKG 60.36
Umivalnik 60 cm
Umivaonik 60 cm
Basin 60 cm
Waschbecken 60 cm
• 60/5/46
Element pod umivalnikom 60 cm
Element ispod umivaonika 60 cm
Vanity cabinet 60 cm
Waschbeckenunterschrank 60 cm
• 60/60/45
182,93 PT *

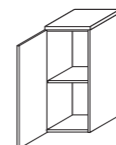

BKG 30.23 L,D
Spodnji element s pokrívno ploščo L,D
Donji element s pokrívnom pločom L,D
Base cabinet with functional top L,R
Unterschrank mit Deckplatte L,R
• 30,2/61,6/36
88,86 PT *

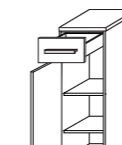

BKG 30.22 L,D
Spodnji element s pokrívno ploščo L,D
Donji element s pokrívnom pločom L,D
Base cabinet with functional top L,R
Unterschrank mit Deckplatte L,R
• 30,2/91,6/36
133,78 PT *

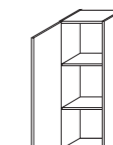

C 30.10 L,D
Viseći element L,D
Donji element L,D
Wall cabinet L,R
Wandschrank L,R
• 30/90/20
64,12 PT *

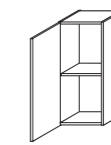

B 30.14 L,D
Viseći element L,D
Donji element L,D
Wall cabinet L,R
Wandschrank L,R
• 30/60/20
50,45 PT *

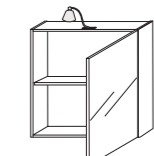

F 60.16 D,L
Viseći element z ogledalom in svetilko L,D
Viseći element s ogledalom i svjetiljkom L,D
Wall-mounted mirror cabinet with light fitting L,D
Spiegelschrank mit leuchte L,D
• 60/60/20
115,55 PT *

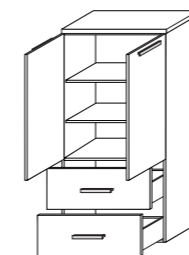

BKG 60.37
Visoka omara s pokrívno ploščo
Visoki ormar s pokrívnom pločom
Tall cabinet with functional top
Hochschrank mit Abdeckplatte
• 60,2/126,6/35
259,75 PT *

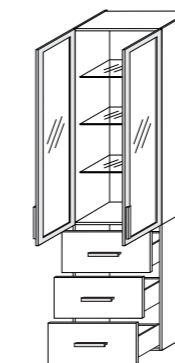

BKG 50.06
Visoka omara
Visoki ormar
Tall cabine
Hochschrank
• 50/195/35
413,71 PT *

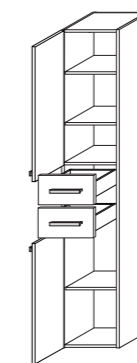

E 30.13 L,D
Visoka omara L,D
Visoki ormar L,D
Tall cabinet L,R
Hochschrank L,R
• 30/180/35
204,74 PT *



Staklena polica
Staklena polica
glass shelf
glasablage
• 60/0,8/15
12,48 PT *



Staklena polica
Staklena polica
glass shelf
glasablage
• 90/0,8/15
14,55 PT *

QUADRA+



◀ FRONT: Weiß Glanz
KORPUS: Weiß Glanz

FAÇADES: blanc brillant
CORPS DE MEUBLE: blanc brillant



FRONT: Weiß Glanz
KORPUS: Weiß Glanz ▶

FAÇADES: blanc brillant
CORPS DE MEUBLE: blanc brillant



QUADRA+



▲ **FRONT UND KORPUS:** Eiche Anthrazit
FAÇADES ET CORPS DE MEUBLE: chêne anthracite



▲ **FRONT UND KORPUS:** Eiche Anthrazit
FAÇADES ET CORPS DE MEUBLE: chêne anthracite

Front und Korpus / Façades et corps de meuble

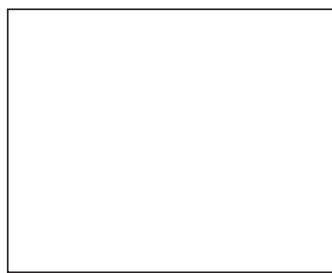

Wei Glanz
 blanc brillant

Eiche Anthrazit
 chêne anthracite

Front / Façades:

- Faserplatte (MDF) Hochglanz foliert : Wei
- Kunststoffoberflche: Eiche Anthrazit
- panneau MDF revtu film PVC blanc brillant
- panneau de particules mlamin chêne anthracite

Korpus / Corps de meuble:

- Kunststoffoberflche: Wei Glanz, Eiche Anthrazit
- panneau de particules mlamin blanc brillant, chêne anthracite

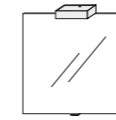

Ogledalo 60x60 cm s svetilko
 Ogledalo 60x60 cm sa svjetiljkom
Mirror 60x60 cm with light fitting
 Spiegel 60x60 cm mit leuchte
 • 60/60/2
69,60 PT *

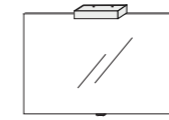

Ogledalo 90x60 cm s svetilko
 Ogledalo 90x60 cm sa svjetiljkom
Mirror 90x60 cm with light fitting
 Spiegel 90x60 cm mit leuchte
 • 90/60/2
112,44 PT *



Ogledalo 60x90 cm s svetilko
 Ogledalo 60x90 cm sa svjetiljkom
Mirror 60x90 cm with light fitting
 Spiegel 60x90 cm mit leuchte
 • 60/90/2
83,18 PT *

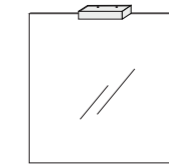

Ogledalo 90x90 cm s svetilko
 Ogledalo 90x90 cm sa svjetiljkom
Mirror 90x90 cm with light fitting
 Spiegel 90x90 cm mit leuchte
 • 90/90/2
122,88 PT *

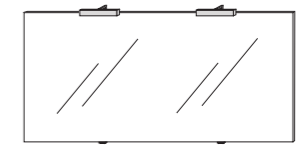

Ogledalo 120x60 cm s svetilko
 Ogledalo 120x60 cm sa svjetiljkom
Mirror 120x60 cm with light fitting
 Spiegel 120x60 cm mit leuchte
 • 120/60/2
132,53 PT *

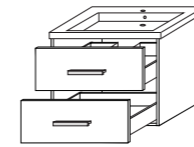

BKG 60.35
 Umivalnik 60 cm
 Umivaonik 60 cm
 Basin 60 cm
 Waschbecken 60 cm
 • 60/5/46
 Element pod umivalnikom 60 cm
 Element ispod umivaonika 60 cm
Vanity cabinet 60 cm
 Waschbeckenunterschrank 60 cm
 • 60/50/45
243,47 PT *

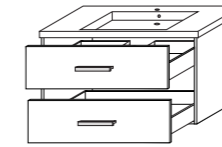

BKG 90.21
 Umivalnik 90 cm
 Umivaonik 90 cm
 Basin 90 cm
 Waschbecken 90 cm
 • 90/5/46
 Element pod umivalnikom 90 cm
 Element ispod umivaonika 90 cm
Vanity cabinet 90 cm
 Waschbeckenunterschrank 90 cm
 • 90/50/45
285,46 PT *

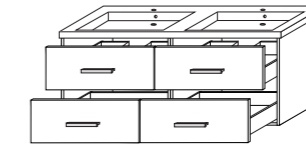

BKG 120.42
 Umivalnik 120 cm
 Umivaonik 120 cm
 Basin 120 cm
 Waschbecken 120 cm
 • 120/5/46
 Element pod umivalnikom 120 cm
 Element ispod umivaonika 120 cm
Vanity cabinet 120 cm
 Waschbeckenunterschrank 120 cm
 • 120/50/45
439,75 PT *

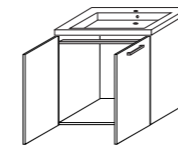

BKG 60.36
 Umivalnik 60 cm
 Umivaonik 60 cm
 Basin 60 cm
 Waschbecken 60 cm
 • 60/5/46
 Element pod umivalniko 60 cm
 Element ispod umivaonika 60 cm
Vanity cabinet 60 cm
 Waschbeckenunterschrank 60 cm
 • 60/60/45
182,93 PT *

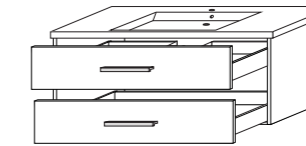

F120.65+UM120.95
 Umivalnik 120 cm
 Umivaonik 120 cm
 Basin 120 cm
 Waschbecken 120 cm
 • 120/5/46
 Element pod umivalnikom 120 cm
 Element ispod umivaonika 120 cm
Vanity cabinet 120 cm
 Waschbeckenunterschrank 120 cm
 • 120/50/45
285,46 PT *

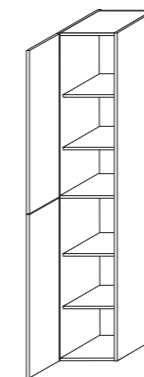

E 30.05 L,D
 Visoka omara L,D
 Visoki ormar L,D
 Tall cabinet L,R
 Hochschrank L,R
 • 30/180/35
137,92 PT *

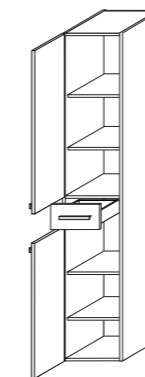

E 30.06 L,D
 Visoka omara L,D
 Visoki ormar L,D
 Tall cabinet L,R
 Hochschrank L,R
 • 30/180/35
176,11 PT *



Staklena polica
 Staklena polica
glass shelf
 glasablage
 • 60/0,8/15
12,48 PT *



Staklena polica
 Staklena polica
glass shelf
 glasablage
 • 90/0,8/15
14,55 PT *

Čista resnica: za bakterije ni prostora
 Čista istina: nema mjesta za bakterije

Pure truth: no room for bacteria

Die reine Wahrheit: kein Platz für Bakterien



◀ Brez skrbi: tudi vaši najmlajši bodo v kopalnici Gorenje varnejši. Sanitarna oprema je izdelana iz materiala, čigar receptura zagotavlja izjemno antibakteriološko delovanje površine. Na popolnoma nepropustni in za madeže neobčutljivi površini se pod vplivom vode izločajo ioni, ki preprečujejo rast in razmnoževanje bakterij, kar je dokazano s certifikatom Sanitized®. Učinkovitost je zagotovljena skozi vso življenjsko dobo sanitarne opreme.

Bez brige: u kupaonici Gorenje biti će i vaši najmlađi sigurniji. Sanitarna je oprema proizvedena od materijala čija receptura osigurava iznimno protubakterijsko djelovanje površine. Na potpuno nepropusnoj i na mrlje neosjetljivoj površini pod utjecajem vode izlučuju se ioni koji sprečavaju rast i razmnožavanje bakterija, što je dokazano certifikatom Sanitized®. Učinkovitost je zajamčena za cijeli životni vijek sanitarne opreme.

No worries: Even the youngest of your children will be safer in a Gorenje bathroom. Sanitary ware is made of material whose composition gives the surface exceptional antibacterial properties. On the totally impermeable and stain resistant surface and under the influence of water, ions are released to prevent bacterial growth and multiplication, which is confirmed by the Sanitized® certificate. Efficiency is guaranteed throughout the entire service life of the sanitary ware.

Ohne Sorgen: auch Ihre Kleinsten werden im Gorenje Badezimmer sicherer sein. Das zur Herstellung der Sanitäreinrichtung verwendete Material garantiert die hervorragende antibakteriologische Wirkung der Oberfläche. Auf der wasser- und feckenbeständigen Oberfläche können die Bakterien durch die Wirkung der freigelassenen Ionen nicht wachsen und sich vermehren. Das ist durch das erworbene Zertifikat Sanitized® nachgewiesen. Diese Wirksamkeit bleibt über die ganze Lebensdauer der Sanitäreinrichtung unverändert.



WC 39.28
 WC školjka Kuba
 WC školjka Kuba
 Toilete bowl Kuba
 Toiletschüssel Kuba
 639,41 PT *

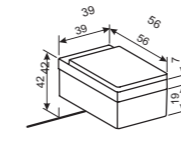

WC 39.28

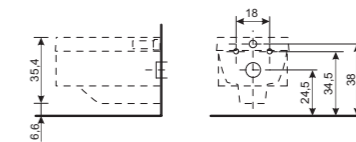

WC 39.28



BD 39.28
 Bide Kuba
 Bide Kuba
 Bidet Kuba
 Bidet Kuba
 407,57 PT *

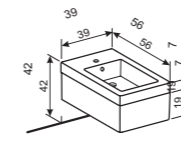

BD 39.28

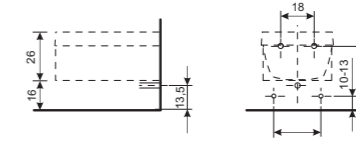

BD 39.28

10-25



WC 39.27
 WC školjka Julija
 WC školjka Julija
 Toilete bowl Julija
 Toiletschüssel Julija
 531,76 PT *

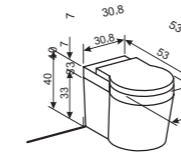

WC 39.27

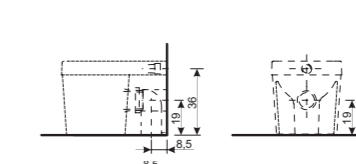

WC 39.27



BD 39.27
 Bide Julija
 Bide Julija
 Bidet Julija
 Bidet Julija
 337,92 PT *

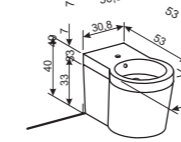

BD 39.27

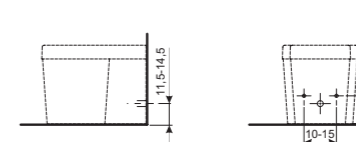

BD 39.27

10-15



WC 39.26
 425,80 PT *

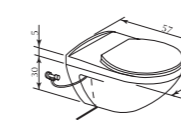

WC 39.26

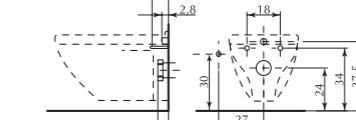

WC 39.26

WC 39.26 - s šobo za izpiranje
 WC 39.26 - sa mlaznicom za ispiranje
 WC 39.26 - flush toilet with trigger nozzle
 WC 39.26 - mit Spüldüse



WC 39.23
 405,08 PT *

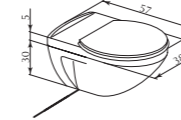

WC 39.23

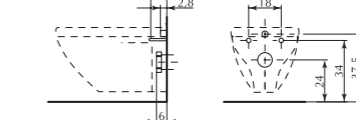

WC 39.23



BD 39.23
 251,82 PT *

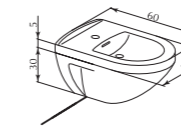

BD 39.23

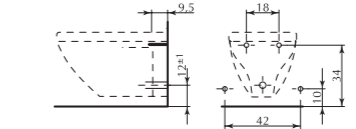

BD 39.23

Tuš kadi in kabine / Tuš-kade i kabine / Shower trays and cabins / Duschwannen und -kabinen

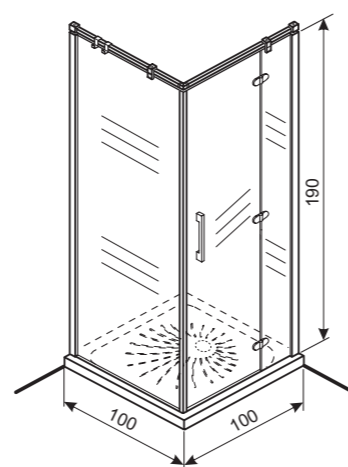
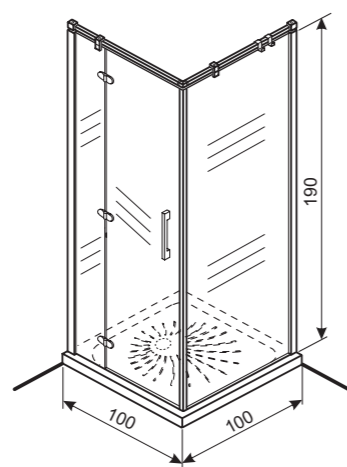

KTK 100.37
Kaljeno prozorno steklo z Antiplaque premazom
Kaljeno prozorno staklo s premazom Antiplaque
Tempered transparent glass with Antiplaque coating
gehärtetes Klarglas mit Antiplaque Beschichtung
865,37 PT *

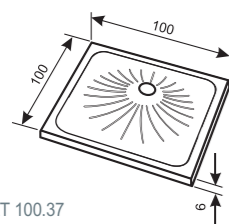

KT 100.37
214,93 PT *

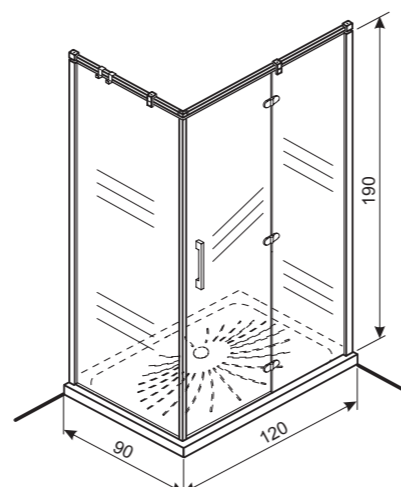
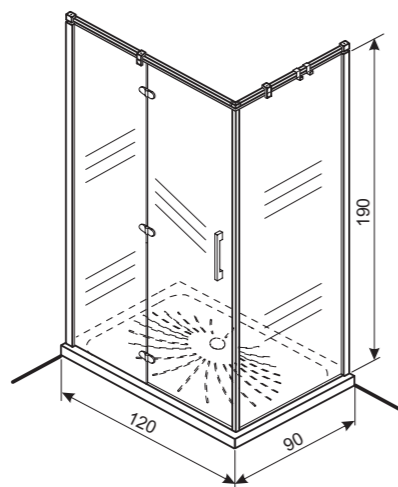
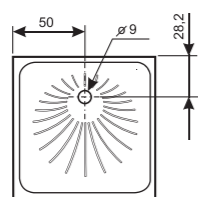

KTK 120.40
Kaljeno prozorno steklo z Antiplaque premazom
Kaljeno prozorno staklo s premazom Antiplaque
Tempered transparent glass with Antiplaque coating
gehärtetes Klarglas mit Antiplaque Beschichtung
886,78 PT *

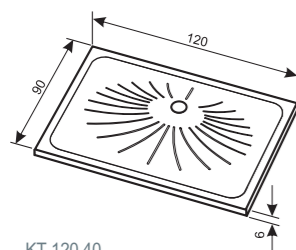

KT 120.40
218,86 PT *

* Cena v točkah / Cijena u točkama / Price in points / Preis in Punkten

Tuš kadi in kabine / Tuš-kade i kabine / Shower trays and cabins / Duschwannen und -kabinen

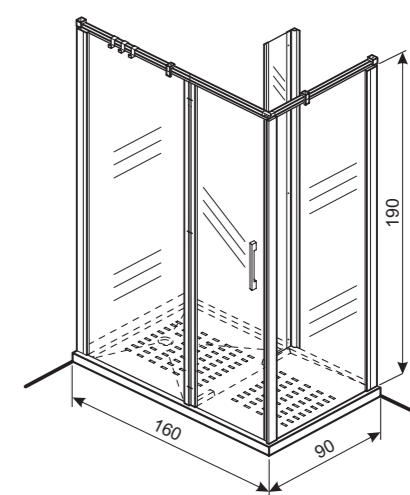
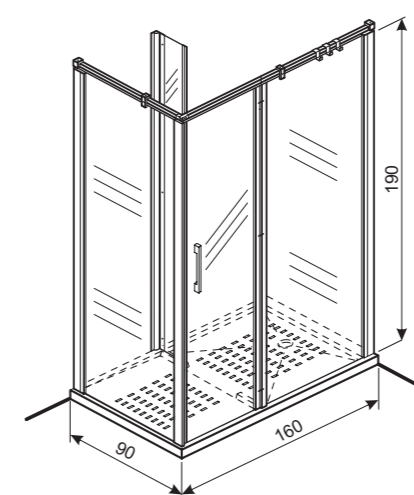

KTK 160.75
Tuš kabina Kuba
Kaljeno prozorno steklo z Antiplaque premazom
Kaljeno prozorno staklo s premazom Antiplaque
Tempered transparent glass with Antiplaque coating
gehärtetes Klarglas mit Antiplaque Beschichtung
1.300,78 PT *

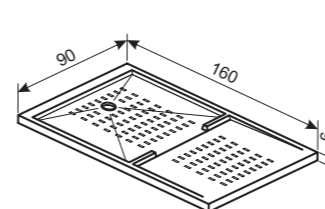

KT 160.75
Tuš kad Kuba
288,88 PT *

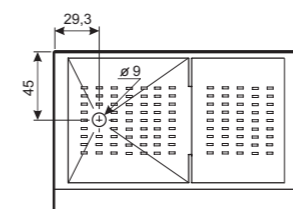

Tuš kad in kabina Kuba / Tuš-kada i kabina Kuba
Shower tray and cabin Kuba / Duschwanne und -kabine Kuba

Izpod prhe stopimo suhi v odprt prostor ...
Zakaj pa ne tudi v spalnico?
To nam omogoča inovativna rešitev vrtljivih vrat tuš kabine.

Od tuša stupamo suhi u prostor...
Zašto ne bismo i u spavaću sobu?
To omogućuje inovativno rješenje rotacijskih vrata tuš-kabine.

We exit the shower, already dry and enter the room... Why not the bedroom as well? This is made possible by an innovative solution of the shower cabin's revolving door.

Aus der Dusche treten wir in einen trockenen Raum... Warum nicht auch in das Schlafzimmer? Das ermöglicht uns die innovative Lösung mit Drehtüren der Duschkabine.

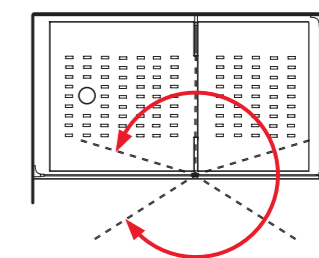

Antiplaque zaščitni premaz / Zaštitni premaz antiplaque
Antiplaque protective coating / Antiplaque Schutzbeschichtung



Antiplaque premaz je zaščitni premaz, ki poskrbi, da vodne kapljice hitreje zdrsnejo po površini stekla. Preprečuje odlaganje apnenca in nečistoč na steklu.

Zaštitni premaz Antiplaque jest zaštitni premaz koji omogućuje da kapljice vode brže skliznu po površini stakla. Sprječava odlaganje vapnenca i nečistoća na staklu.

Antiplaque coating is a protective coating which makes water drops glide faster on the glass surface, thus preventing limescale and impurities from depositing on glass.

Durch die Antiplaque Schutzbeschichtung wird die Glasoberfläche schneller trocken. Kalk und Schmutz können nicht am Glas abgelagert werden.

* Cena v točkah / Cijena u točkama / Price in points / Preis in Punkten

Tuš kadi in kabine / Tuš-kade i kabine / Shower trays and cabins / Duschwannen und -kabinen

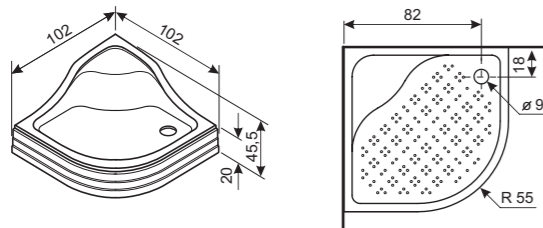
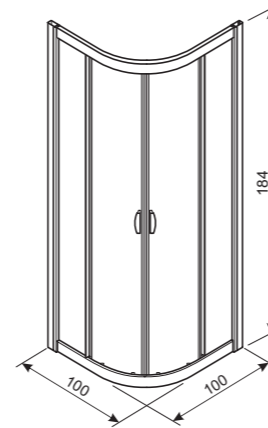

KT 102.65
423,21 PT *

KTK 102.65
Kajjeno mat steklo in bel okvir
Kajjeno mat staklo i bijeli okvir
Tempered opaque glass and white frame
gehärtetes Mattglas und weiß Korpus
783,10 PT *

KTK 102.66
Kajjeno mat steklo in ALU okvir
Kajjeno mat staklo i ALU okvir
Tempered opaque glass and ALU frame
gehärtetes Mattglas und ALU Korpus
783,10 PT *

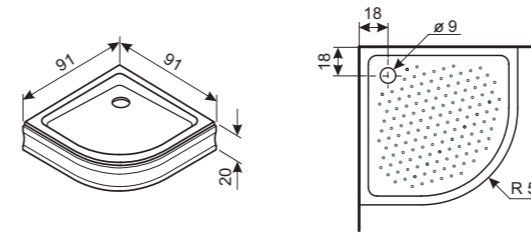
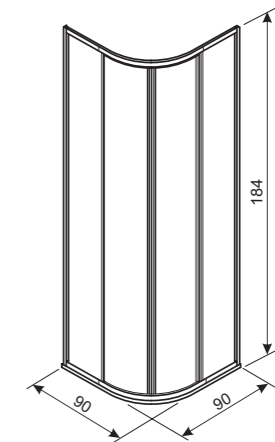

KT 91.60
324,08 PT *

KTK 91.60
Polistiren in bel okvir
Polistiren i bijeli okvir
Polystyrene and white frame
Polistiren und weiß Korpus
280,03 PT *

KTK 91.61
Polistiren in ALU okvir
Polistiren i ALU okvir
Polystyrene and ALU frame
Polistiren und ALU Korpus
280,03 PT *

KTK 91.62
Kajjeno mat steklo in bel okvir
Kajjeno mat staklo i bijeli okvir
Tempered opaque glass and white frame
gehärtetes Mattglas und weiß Korpus
341,30 PT *

KTK 91.63
Kajjeno mat steklo in ALU okvir
Kajjeno mat staklo i ALU okvir
Tempered opaque glass and ALU frame
gehärtetes Mattglas und ALU Korpus
341,30 PT *

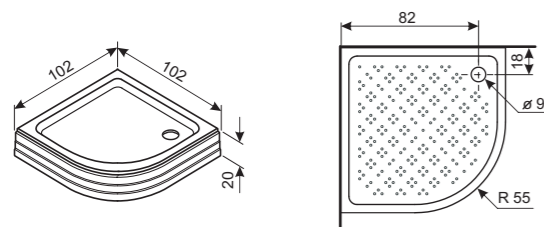
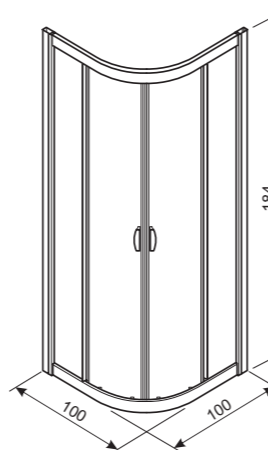

KT 102.70
356,38 PT *

KTK 102.65
Kajjeno mat steklo in bel okvir
Kajjeno mat staklo i bijeli okvir
Tempered opaque glass and white frame
gehärtetes Mattglas und weiß Korpus
783,10 PT *

KTK 102.66
Kajjeno mat steklo in ALU okvir
Kajjeno mat staklo i ALU okvir
Tempered opaque glass and ALU frame
gehärtetes Mattglas und ALU Korpus
783,10 PT *

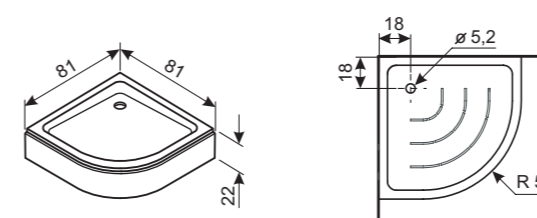
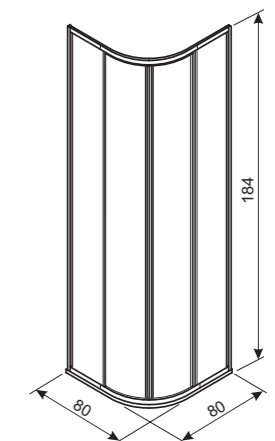

KT 81.55
288,05 PT *

KTK 81.55
Polistiren in bel okvir
Polistiren i bijeli okvir
Polystyrene and white frame
Polistiren und weiß Korpus
211,90 PT *

* Cena v točkah / Cijena u točkama / Price in points / Preis in Punkten

* Cena v točkah / Cijena u točkama / Price in points / Preis in Punkten

Kopalne kadi in obloge kopalnih kadi / Kade za kupanje i obloge kada za kupanje
 Bathtubs and bathtub front panels / Badewannen und Badewannenbeläge

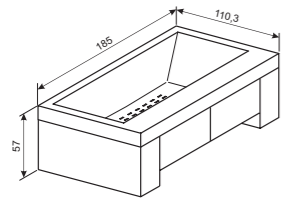

KK 185.28
 Kopalna kad Kuba
 Barve predalov: bela sijaj, črna sijaj
 Kada za kupanje Kuba
 Boje ladice: bijela sjaj, črna sjaj
 Bathtub Kuba
 Colours of drawers: white gloss, black gloss
 Badewanne Kuba
 Die Farben der Schubladen: Weiß glanz, Schwarz glanz
1.380,20 PT *

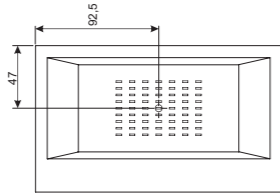

KK 180.36
 Kopalna kad Julija (iz materiala Soligor Polar)
 Kada za kupanje Julija (od materiala Soligor Polar)
 Bathtub Julija (made of Soligor Polar material)
 Badewanne Julija (Material Soligor Polar)
1.095,32 PT *

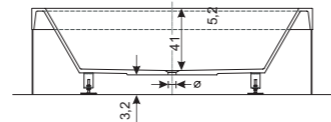

KK 180.36
 Kopalna kad Julija (iz materiala Soligor Polar)
 Kada za kupanje Julija (od materiala Soligor Polar)
 Bathtub Julija (made of Soligor Polar material)
 Badewanne Julija (Material Soligor Polar)
1.095,32 PT *

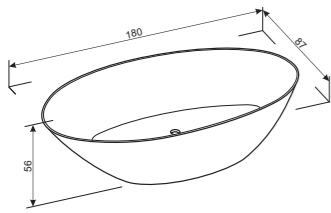

KK 156.04 L, D
 Kopalna kad luna
 Kada za kupanje luna
 Bathtub luna
 Badewanne luna
560,96 PT *

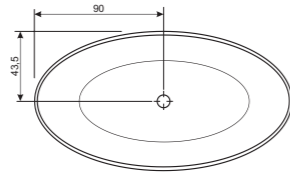

KK 156.04 L
 Kopalna kad luna
 Kada za kupanje luna
 Bathtub luna
 Badewanne luna
560,96 PT *

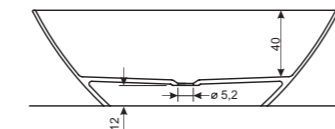

OKK 155.04 L
176,08 PT *

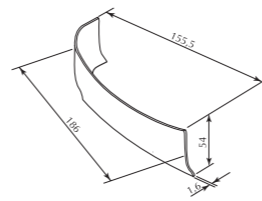

OKK 155.04 D
176,08 PT *



Masažna tuširna stena DUNA / Masažni tuš - panel DUNA
 Massage shower column DUNA / Massage - Duschwand DUNA



- Funkcije sistema:
- 4 vertikalne šobe
 - ročni tuš z nosilcem
 - veliki tuš za glavo
 - regulator vodnega curka
- Funkcije sistema:
- 4 vertikalne mlaznice
 - ručni tuš s nosačem
 - veliki tuš za glavu
 - regulator vodenog mlaza
- System features:
- 4 vertical nozzles
 - Hand-held shower unit with mount and hose
 - large over head shower unit
 - Massage jet control unit
- Funktionen des Systems:
- 4 vertikale Düsen
 - Handdusche mit dem Träger
 - große Kopfdusche
- 980,15 PT ***

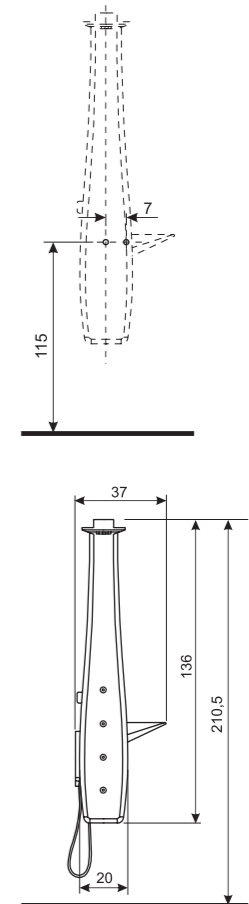

Zaslони kopalnih kadi / Zaslони za kade za kupanje / Bathtub screens / Badewanne Spritzwand

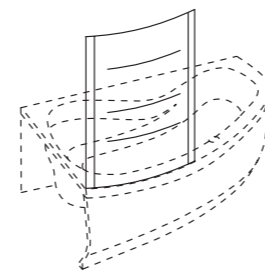

ZKK 93.02 L
 Zaslon za kopalno kad KK 156.04 L
 Zaslon za kadu za kupanje KK 156.04 L
 Bathtub screen for KK 156.04 L
 Badewanne Spritzwand KK 156.04 L
310,40 PT *

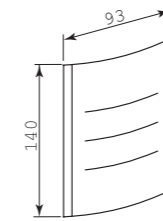

ZKK 93.02 L
 Zaslon za kopalno kad KK 156.04 L
 Zaslon za kadu za kupanje KK 156.04 L
 Bathtub screen for KK 156.04 L
 Badewanne Spritzwand KK 156.04 L
310,40 PT *

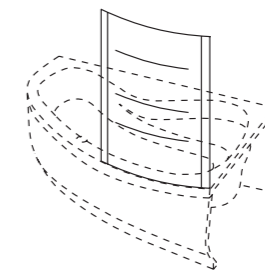

ZKK 93.02 D
 Zaslon za kopalno kad KK 156.04 D
 Zaslon za kadu za kupanje KK 156.04 D
 Bathtub screen for KK 156.04 R
 Badewanne Spritzwand KK 156.04 R
310,40 PT *

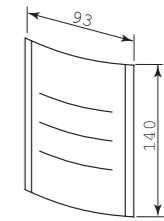

ZKK 93.02 D
 Zaslon za kopalno kad KK 156.04 D
 Zaslon za kadu za kupanje KK 156.04 D
 Bathtub screen for KK 156.04 R
 Badewanne Spritzwand KK 156.04 R
310,40 PT *

Program barv sanitarne opreme / Program boja sanitarne opreme
Sanitary ware colours / Farben der Sanitäreinrichtung

DOLOPOL



Biser

Sanitarna je oprema proizvedena od kompozitnoga materijala, čija je osnova mljeveni kamen, povezan poliesterskom smolom.

Otpornost
Materijal je otporan na djelovanje uobičajenih kozmetičkih, dezinfekcijskih sredstava te sredstava za čišćenje. Iznimka su kiseline i lužine u koncentracijama većim od 10%. Materijal je neosjetljiv na razne mrlje, elastičan i teško lomljiv. Površina je nepropusna i ugodna na dodir.

Održavanje
Za čišćenje proizvoda od kompozitnoga materijala možete koristiti uobičajena tekuća sredstva za čišćenje. Ne upotrebljavajte sredstva za čišćenje koja sadrže sitno mljeveni pijesak ili slične grube materijale, jer oštećuju površinu koja potom postane mutna.

Proizvodi osnovne sanitarne opreme od kompozitnoga materijala odgovaraju internome standardu gNOS 19, čija su osnova međunarodni standardi (ANSI, DIN EN)

Sanitary ware is made of composite material based on ground stones bound with polyester resin.

Resistance
The material is resistant to common cosmetics, disinfectants and cleaning agents. The only exceptions are acids and lye in concentrations exceeding 10%. The material is stain resistant, resilient and hard to fracture. The surface is impermeable and pleasant to the touch.

Maintenance
Products made of composite material may be cleaned by using ordinary liquid detergents. Do not use cleaners containing fine sand or similar abrasive ingredients, as these tend to damage and dull the surface.

Basic sanitary ware products made of composite material comply with the internal standard gNOS 19 based on international standards (ANSI, DIN EN).

Sanitarna oprema je izdelana iz kompozitnega materiala, katerega osnova je mlet kamen, povezan s poliestersko smolo.

Odpornost
Material je odporen na delovanje običajnih kozmetičnih, dezinfekcijskih in čistilnih sredstev. Izjema so kisline in lugi v koncentracijah večjih od 10%. Material je neobčutljiv na razne madeže, elastičen in težko lomljiv. Površina je nepropustna in prijetna na dotik.

Vzdrževanje
Za čiščenje izdelkov iz kompozitnega materiala lahko uporabljamo običajna tekoča čistilna sredstva. Ne uporabljajte čistil, ki vsebujejo drobno mleti pesek ali podobne grobe materiale, saj poškodujejo površino in ta postane motna. Izdelki osnovne sanitarne opreme iz umetnega marmorja odgovarjajo internemu standardu gNOS 19, ki ima za osnovo mednarodne standarde (ANSI, DIN EN).

Die Sanitäreinrichtung ist aus Kompositmaterial hergestellt, dessen Basis ist der gemahlene Stein mit Kunstharz gebunden.

Beständigkeit
Das Material ist gegen Wirkung der üblichen kosmetischen, Desinfektions- und Reinigungsmittel beständig. Die Ausnahme sind nur die Säuren und laugen in Konzentrationen höher als 10%. Das Material ist unempfindlich gegen verschiedene Flecken, er ist elastisch und nahezu bruchsicher. Die Oberfläche ist undurchlässig und berührungsgenehm.

Wartung
Produkte aus Kompositmaterial können mit üblichen flüssigen Reinigungsmitteln gereinigt werden. Die Anwendung der Reinigungsmittel mit feingemahltem Sand oder ähnlichen grobmaterialien ist nicht zulässig, denn die Oberfläche kann beschädigt und glanzlos werden. Die Elemente der Sanitäreinrichtung aus Kompositmaterial entsprechen dem internen Standard gNOS 19, der auf dem internationalen Standard (ANSI, DIN EN) basiert.

Označevanje odpiranja vrat / Označavanje otvaranja vrata
Door opening direction / Bezeichnung für die Öffnungsrichtung von Türen

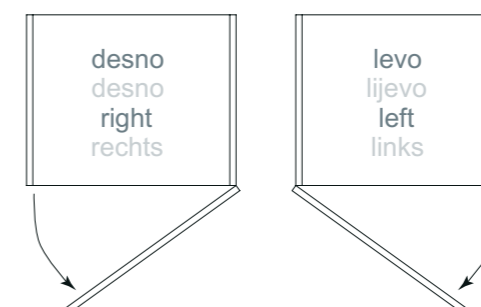

Označevanje dimenzij / Označavanje mjera / Dimensions / Bezeichnung für die Dimensionen

A / B / C
35 / 145 / 33
širina / višina / globina

A / B / C
35 / 145 / 33
širina / visina / dubina

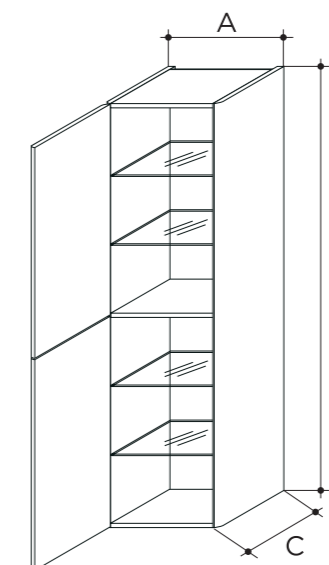

A / B / C
35 / 145 / 33
width / height / depth

A / B / C
35 / 145 / 33
Breite / Höhe / Tiefe

Dodatna oprema / Dodatna oprema / Accessories / Zusatzprogramm

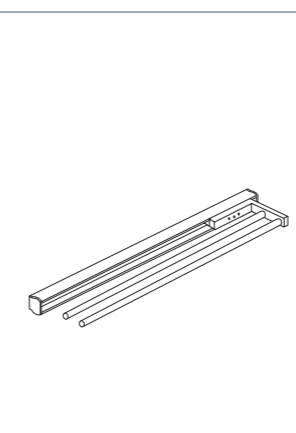
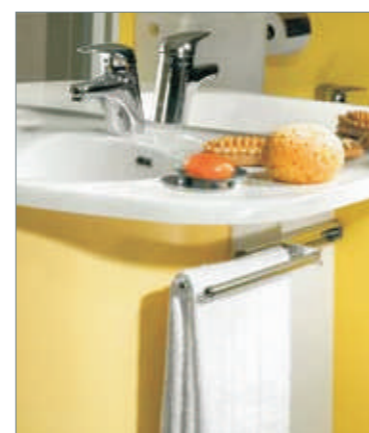

OB 0.08
Obešalnik brisač
Držač ručnika
Towel rail
Handtuchhalter
22,70 PT *

* Cena v točkah / Cijena u točkama / Price in points / Preis in Punkten

Drobni sanitarni set / Sitni sanitarni komplet
Miscellaneous bathroom accessories / Kleiner Sanitärset

• SMART / SMART / SMART / SMART



NŠ 0.04
Nosilec ščetk
Nosáč četkica
Toothbrush holder
Bürstenhalter
66,20 PT *



NM 0.06
Nosilec mila
Nosáč sapuna
Soap holder
Seifenhalter
66,13 PT *



NM 0.07
Nosilec mila
Nosáč sapuna
Soap holder
Seifenhalter
120,95 PT *



NP 0.04
Nosilec papirja
Nosáč papira
Toilet paper roll holder
Papierträger
66,15 PT *



OB 0.14
Obešalnik brisač 40 cm
Držáč ručnika 40 cm
Towel rail 40 cm
Handtuchhalter 40 cm
118,95 PT *



OB 0.15
Obešalnik brisač 60 cm
Držáč ručnika 60 cm
Towel rail 60 cm
Handtuchhalter 60 cm
124,23 PT *



OK 0.01
Kozmetično ogledalo
Kozmetičko ogledalo
Mirror
Kosmetikspiegel
112,85 PT *



PM 0.04
Posoda z WC ščetko
Posuda s WC četkom
Toilet brush set
Behälter für WC Bürste
172,75 PT *

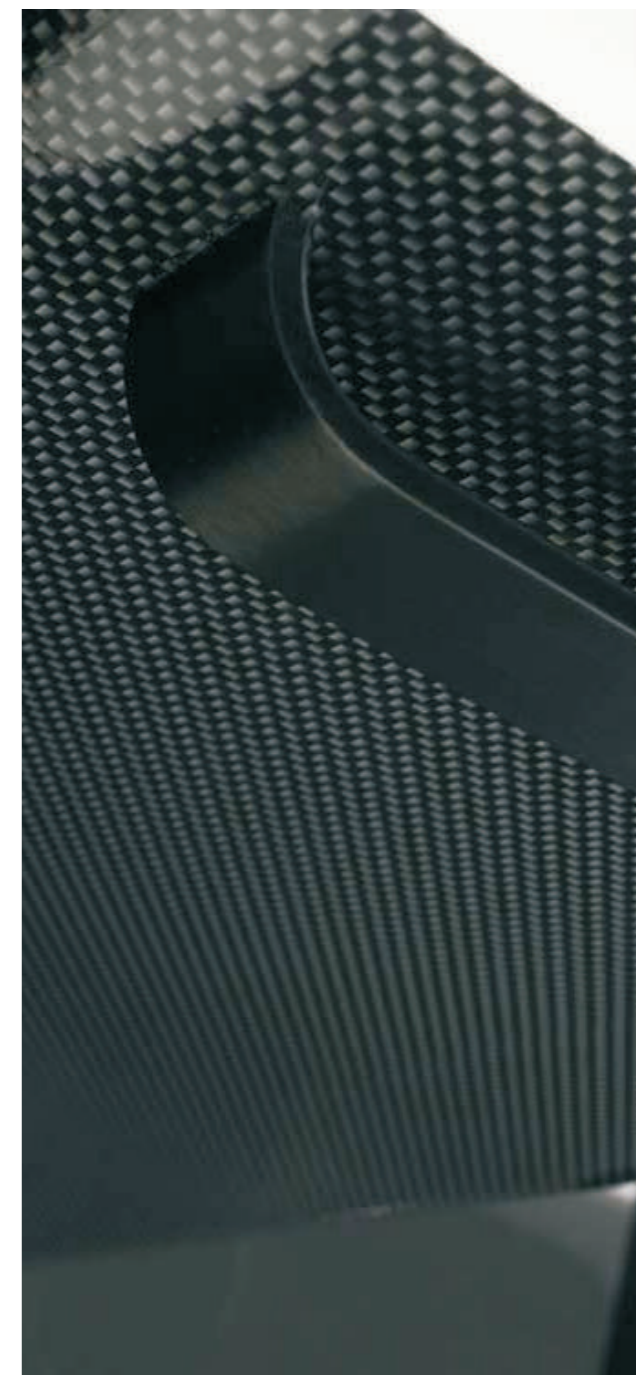
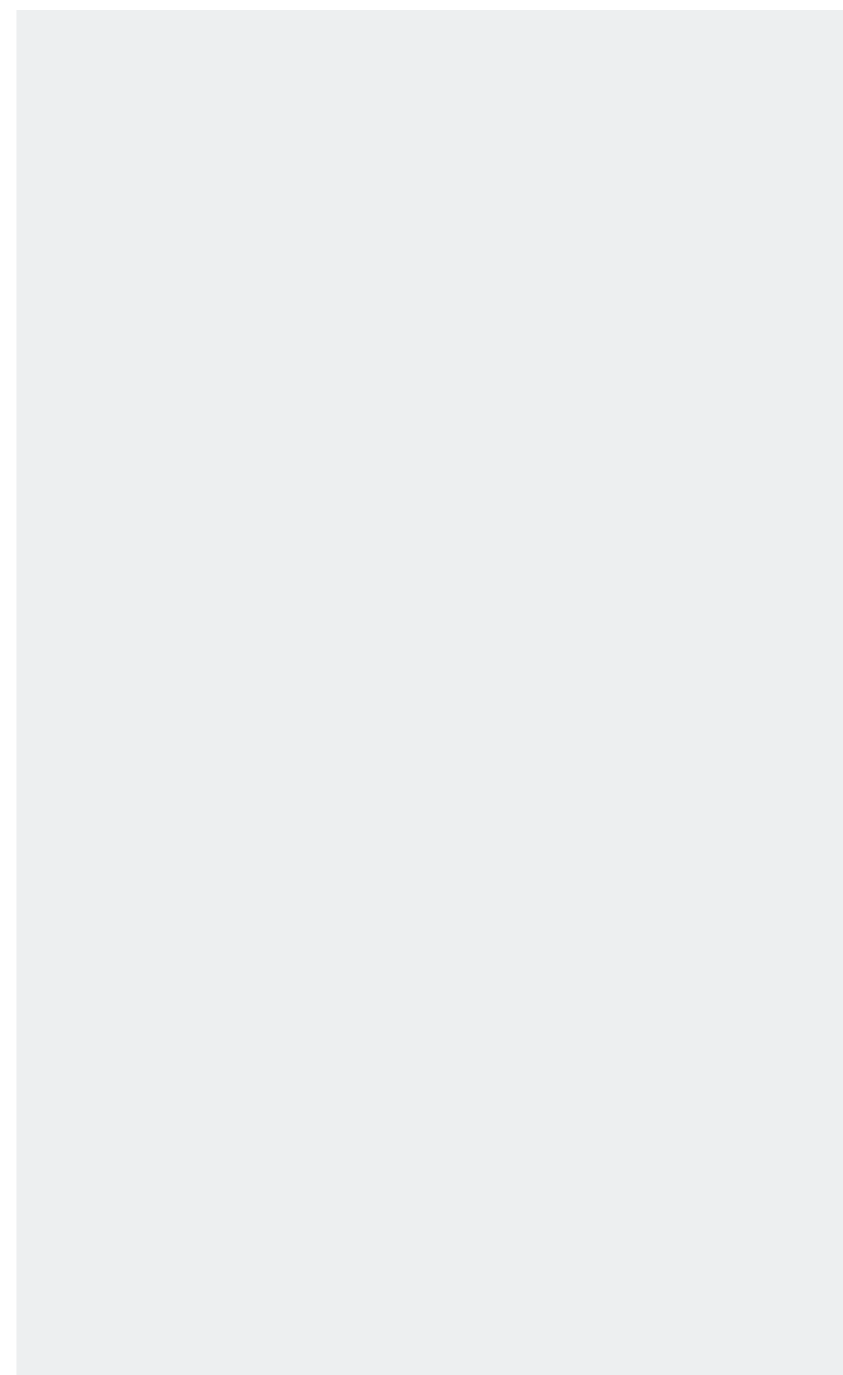

PREGLED PONUDBE

Ogledala, omarice z ogledali, svetilke in ročaji.

OUR OFFER

Mirrors, miror cabinets, lamps and handles.







PREDLED PONUDE

Umivaonici, ogledala, ormariči s ogledalima, svijetilke i ručke.

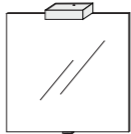
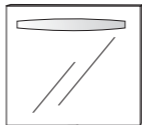
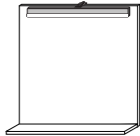
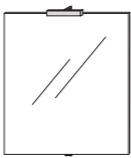
PRÜFUNG DES ANGEBOTS

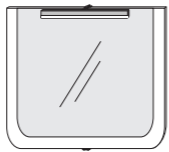
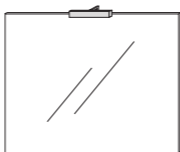
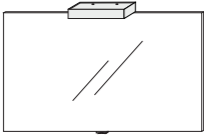
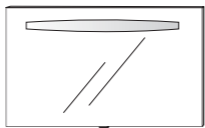
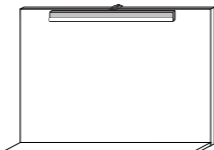
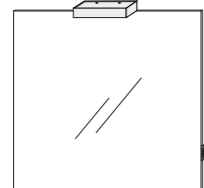
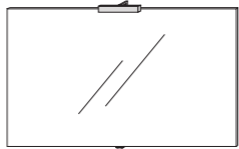
Waschbecken, Spiegel, Spiegelschranke, Leuchten und Griffe.

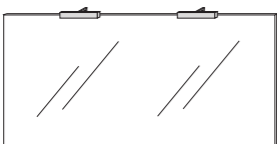
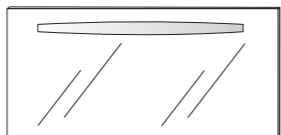





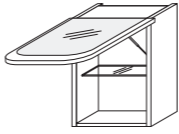
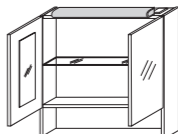
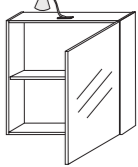
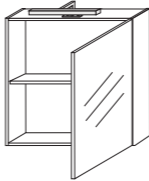
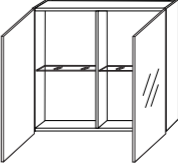
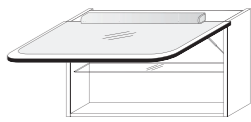
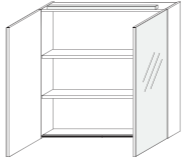
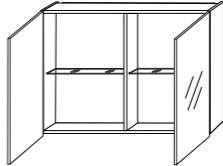
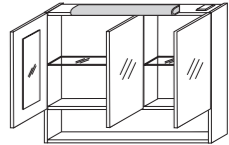
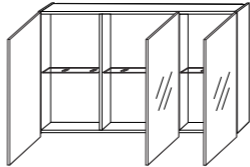
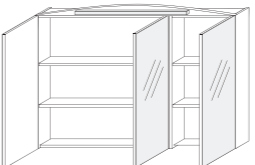
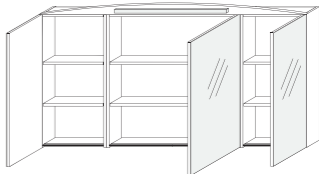







Ogledala / Ogledala / Mirrors / Spiegel

SKG 35.03 (35x75x2) Bonsai, Jazz small, Julija svetilka / svjetiljka / lamp / leuchte: Moira 	Ogledalo (60x60x2) Quadra, Quadra+ svetilka / svjetiljka / lamp / leuchte: Salma 1 	F 60.04 (60x60x4,5) Fresh karisma z vgrajeno svetilko / sa ugrađenom svjetiljkom / with build-in light / mit eingebauter Leuchte 
SKG 60.03 (60x75x15,3) Avon svetilka / svjetiljka / lamp / leuchte: Ruth Polica v barvah programa Avon Polica u bojama programa Avon Shelf in colours of the Avon programme palette Ablage in Farben des Avon Programms 	Ogledalo (60x80x2) Alano, Amador, Leonides, Lorencio, Slim svetilka / svjetiljka / lamp / leuchte: Veronica 	Ogledalo (60x90x2) Quadra, Quadra+ svetilka / svjetiljka / lamp / leuchte: Salma 1 
Ogledalo (70x70x2) Oasis svetilka / svjetiljka / lamp / leuchte: Ruth 	SKG 75.03 (75x75x2) Jazz svetilka / svjetiljka / lamp / leuchte: Ruth Panel v barvah programa Jazz Panel u bojama programa Jazz Panel in colours of the Jazz programme palette Panneel in Farben des Jazz Programms 	Ogledalo (80x60x2) Alano, Amador, Leonides, Lorencio, Slim svetilka / svjetiljka / lamp / leuchte: Veronica 
Ogledalo (90x60x2) Quadra, Quadra+ svetilka / svjetiljka / lamp / leuchte: Salma 2 	F 60.04 (90x60x4,5) Fresh karisma z vgrajeno svetilko / sa ugrađenom svjetiljkom / with build-in light / mit eingebauter Leuchte 	SKG 90.03 (90x75x15,3) Avon svetilka / svjetiljka / lamp / leuchte: Ruth Polica v barvah programa Avon Polica u bojama programa Avon Shelf in colours of the Avon programme palette Ablage in Farben des Avon Programms 
Ogledalo (90x90x2) Quadra, Quadra+ svetilka / svjetiljka / lamp / leuchte: Salma 2 	Ogledalo (100x60x2) Amador, Leonides, Lorencio, Slim svetilka / svjetiljka / lamp / leuchte: Veronica 	Ogledalo (105x70x2) Oasis svetilka / svjetiljka / lamp / leuchte: Ruth 
Ogledalo (120x60x2) Alano, Amador, Leonides, Lorencio, Quadra, Quadra+ svetilka / svjetiljka / lamp / leuchte: Veronica 	F 120.04 (120x60x4,5) Fresh karisma z vgrajeno svetilko / sa ugrađenom svjetiljkom / with build-in light / mit eingebauter Leuchte 	Ogledalo (140x70x2) Oasis svetilka / svjetiljka / lamp / leuchte: Ruth 









Omarice z ogledali / Ormarići s ogledalima / Mirror cabinets / Spiegelschränke

F 35.03 (35x40x16) Jazz 	F 60.02 (60x75x20) Avon svetilka / svjetiljka / lamp / leuchte: Brick R 	F 60.11 L,D (60x60x20) Quadra svetilka / svjetiljka / lamp / leuchte: Art. 81 
F 60.11 L,D (60x60x20) Fresh svetilka / svjetiljka / lamp / leuchte: Cali mat 	F 60.15 (60x60x15) Alano, Amador, Leonides, Lorencio 	F 70.13 (75x40x16) Jazz svetilka / svjetiljka / lamp / leuchte: Brick R 
F 70.40 (70x70x18,4) Oasis svetilka / svjetiljka / lamp / leuchte: Lineon 	F 80.15 (80x60x15) Alano, Amador, Leonides, Lorencio 	F 90.22 (90x75x20) Avon svetilka / svjetiljka / lamp / leuchte: Brick R 
F 100.15 (100x60x15) Alano, Amador, Leonides, Lorencio 	F 105.40 L,D (105x70x18,4) Oasis svetilka / svjetiljka / lamp / leuchte: Lineon 	F140.04 (140x70x18,4) Oasis svetilka / svjetiljka / lamp / leuchte: Lineon 

Svetilke / Svjetiljke / Lamps / Leuchten

Art.81  752130	Quadra 	BrickR 	Jazz, Avon 	Cali 	Fresh karisma
Moira 	Bonsai, Julija, Jazz Small 	Ruth 	Avon, Jazz, Oasis 	Salma 1 	Quadra, Quadra plus
Salma 2 	Quadra, Quadra plus 	Veronica 	Alano, Amador, Leonides, Lorenzo, Slim, Quadra, Quadra plus 	Lineon 	Oasis
		756088 - F 70.40 755015 - F 105.40 I,D, F 140.04			

Ročaji / Ručke / Handles / Griffe

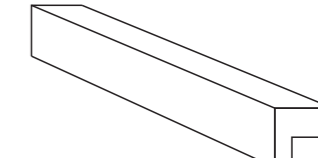
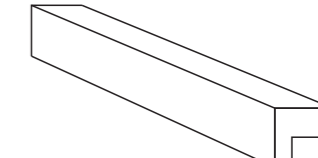
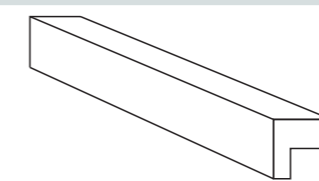
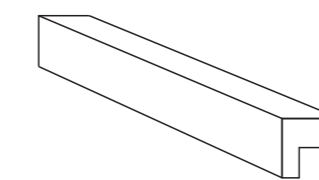
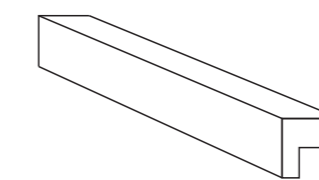
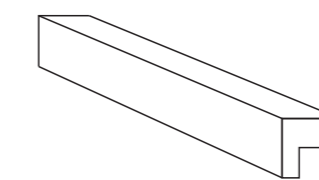
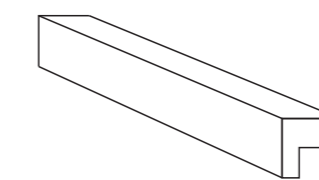
33.Cr/sij (64 mm) 	Catania 	90.Cr/mat 	Avon 	105.Ni (224 mm) 	Slim
95.01 Al (224 mm) 	Jazz 	95.02 črn Al (224 mm) 	Jazz karbon 	87.Cr/mat 	Alano
87.Cr/sij 	Leonides 	87.Cr 	Quadra, Quadra plus 	Quadra, Quadra plus 	Quadra, Quadra plus
krajši ročaj 295 mm, razdalja med izvrtinama - 224 mm daljši ročaj 495 mm, razdalja med izvrtinama - 416 mm					