

gorenje

2011/12

KOPALNICE BATHROOMS





OSEBNO. ZASEBNO. POSEBNO. Kopalnice Gorenje.

Tam, kjer se rojevajo prve ideje dneva, kjer podobe še niso nadele mask, tam se vse začne. V objemu vodnih užitkov, v prostoru sproščujoče intimnosti. Kopalnica je edini kotiček, kjer smo lahko resnično tisto, kar želimo biti. Kreativni, edinstveni, sproščeni, elegantni, klasični, moderni ali usklajena kombinacije vsega. Kakor kopalnica Gorenje, ki v svoji paleti stilov vselej sestavi zrcalo naše osebnosti.

OSOBNO. PRIVATNO. POSEBNO. Kupaonice Gorenje.

Tamo gdje se rađaju prve ideje dana, gdje figure još nisu nadjemale maske, tamo sve počinje. U zagrljaju vodenih užitaka, u prostoru relaksirajuće intimnosti. Kupaonica je jedini kutak u kojemu istinski možemo biti ono što želimo biti. Kreativni, jedinstveni, opušteni, elegantni, klasični, moderni ili usklađena kombinacija svega. Kao kupaonica Gorenje, koja u svojoj paleti stilova uvijek sastavlja zrcalo naše osobnosti.

PERSONAL. PRIVATE. SPECIAL. Bathrooms Gorenje.

Where the first ideas of the day are being born, where the images have not yet put on their masks, it is where it all begins. In an embrace of watery pleasures, in a room of relaxing intimacy. The bathroom is the only place where we really be what we want to be. Creative, unique, relaxed, elegant, classical, modern or a balanced combination of it all. Like a Gorenje bathroom which, using its palette of styles, always composes a mirror of our personality.

PERSÖNLICH. PRIVAT. BESONDERS. Badezimmer Gorenje.

Dort, wo die ersten Ideen des Tages geboren werden, wo die Gestalten noch keine Masken tragen, dort beginnt alles. In der Umarmung des Wassergenusses, im Raum des entspannenden Innersten. Das Badezimmer ist der einzige Ort, wo wir das tatsächlich sein können, was wir sein wollen. Kreativ, einzigartig, entspannt, elegant, klassisch, modern oder in Harmonie mit allem – so wie das Gorenje Badezimmer mit seiner Palette von Stilen immer den Spiegel unserer Persönlichkeit darstellt.

Slike v katalogu se lahko razlikujejo od izdelkov v prodaji. Pridržujemo si pravico do spremembe programa.

Slike u katalogu mogu se razlikovati od proizvoda u prodaji. Pridržavamo pravo izmjene programa.

Pictures in the catalogue may differ from actual retail products. The manufacturer reserves the right to product lines changes.

Die Bilder im Katalog können sich von den Verkaufsprodukten unterscheiden. Änderungen vorbehalten!

USKLAJENO. POPOLNO.

Od keramičnih ploščic, sanitarne opreme, pa vse do zadnjega detajla kopalniškega pohištva. Sestavite popolnost ujemanja barv in oblik.

USKLAĐENO. SAVRŠENO.

Od keramičkih pločica, sanitarne opreme, pa sve do posljednjega detalja namještaja za kupaonice. Sastavite savršenstvo harmonije boja i oblika.

**HARMONISED. PERFECT.**

From ceramic tiles, sanitary ware, to the very last detail of the bathroom furniture. Create the perfection of matching colours and shapes.

HARMONISIERT. PERFEKT.

Von Fliesen, Sanitäreinrichtung bis zum letzten Detail des Badezimmermöbels. Bilden Sie die Perfektion in Harmonisierung von Farben und Formen.

ZAGOTOVLJENO. ČISTO.

Zaupajte dokazom. Sanitarna oprema se ponaša s certifikatom Sanitized®, ki zagotavlja doživljenjsko protibakterijsko zaščito.

ZAJAMČENO. ČISTO.

Pouzdajte se u dokaze. Sanitarnu opremu odlikuje certifikat Sanitized®, koji jamči dugotrajnu protubakterijsku zaštitu.

**GUARANTEED. CLEAN.**

Trust the evidence. Sanitary ware prides itself in the Sanitized® certificate which guarantees long lasting antibacterial protection.

GARANTIERT. SAUBER.

Vertrauen Sie den Beweisen. Die Sanitäreinrichtung zeichnet sich durch das Sanitized® Zertifikat aus, das den langjährigen antibakteriellen Schutz nachweist.

IZBRANO. VEČNO.

Le najbolj kakovostne komponente tvorijo material za izdelavo sanitarne opreme Gorenje. To ji daje dolgo življenjsko dobo in omogoča enostavno vzdrževanje.

ODABRANO. VJEČNO.

Samo najkvalitetnije komponente čine material za izradu sanitarne opreme Gorenje. To joj omogućuje dug životni vijek i jednostavno održavanje.

**SELECTED. ETERNAL.**

Only components of the highest quality are used in the production of the Gorenje sanitary ware. This gives it a long service life and allows easy care.

AUSERWÄHLT. EWIG.

Nur die Spitzenkomponenten bilden das Material zur Herstellung der Gorenje Sanitäreinrichtung und sichern eine lange Lebensdauer und einfache Wartung.

BARVITO. SLIKOVITO.

Ustvarite svojo mavrico barv. Izberite umivalnik, kopalno kad, tuš kad, WC školjko in bide v katerem koli barvnem odtenku.

ŠARENO. SLIKOVITO.

Napravite svoju dugu boja. Odaberite umivaonik, kadu za kupanje, tuš-kadu, WC-školjku i bide u bilo kojoj nijansi.

**COLOURFUL. PICTURESQUE.**

Create your own rainbow of colours. Select a basin, a bathtub, a shower tray, a WC pan and a bidet in any shade of colour.

FARBIG. MALERISCH.

Schaffen Sie Ihren eigenen Regenbogen. Wählen Sie Waschbecken, Badewanne, Duschkabine, Toilettenschüssel und Bidet in beliebiger Farbnuance.

DOVRŠENO. IZKUŠENO.

Tri desetletja razvoja in izkušenj nam dajejo znanje za ustvarjanje dovršenega kopalniškega prostora.

DORAĐENO. PROVJERENO.

Tri desetljeća razvoja i iskustva nude nam znanje za stvaranje dorađenoga kupaoničkoga prostora.

**PERFECT. EXPERIENCED.**

In three decades of development and experience, we have gained expertise to create perfect bathroom space.

PERFEKT. ERFAHREN.

Drei Jahrzehnte der Entwicklung und Erfahrungen sind die Garantie für unsere Kenntnisse, das perfekte Badezimmer zu errichten.

Sestavljeno kopalniško pohištvo / Sastavljeni namještaj za kupaonice
 Assembled bathroom furniture / Badezimmer - Modulare Möbel

MODERN TREND



Kuba	10	Oasis	28
Vega	18	Avon	36
Jazz	22	Slim	44

NEW CLASSIC ROMANCE

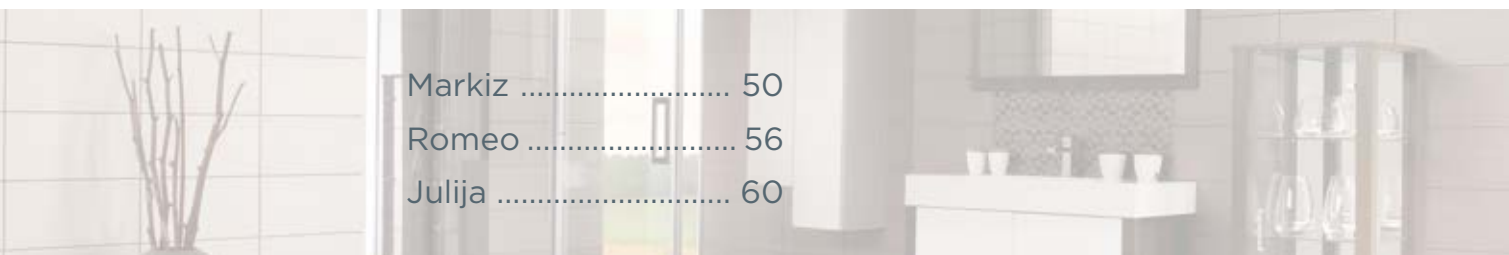

Markiz	50
Romeo	56
Julija	60

STANDARD BEAUTY

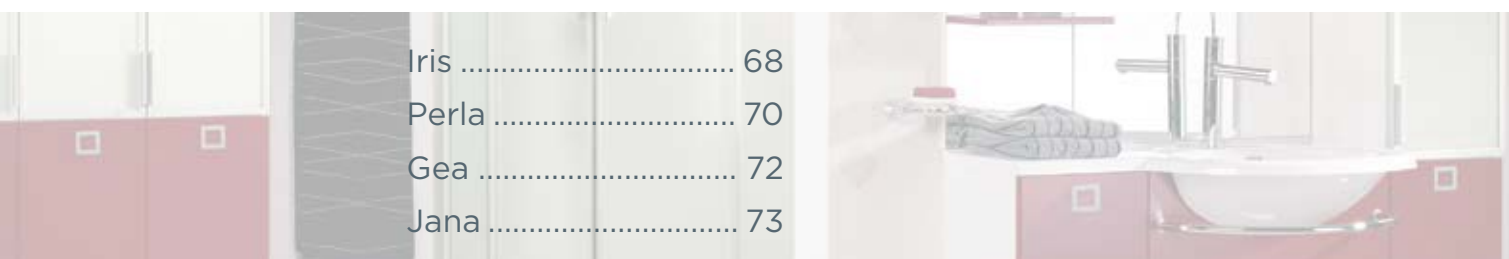

Iris	68
Perla	70
Gea	72
Jana	73

Razstavljeno kopalniško pohištvo / Rastavljeni namještaj za kupaonice
 Unassembled bathroom furniture / Badezimmer - zerlegbare Möbel



Catania	96	Monet	104
Corner	97	Natura	106
Compact	98	Orion	107
Ergo	102	Tango	112
Jana	103	Quadra	116

Sanitarna oprema / Sanitarna oprema / Sanitary ware / Sanitäreinrichtung

Umivalniki Standard / Umivaonici Standard Standard basins / Waschbecken Standard	79
WC školjke in bideji / WC-školjke i bidei WC pans and bidets / Toilettenschüssel und Bidet	81
Tuš kadi in kabine / Tuš-kade i kabine Shower trays and cabins / Duschwannen und -kabinen	82
Masažne tuširne stene / Masažni tuš-paneli Massage shower columns / Massage-Duschwände	86
Kopalne kadi / Kade za kupanje Bathtubs / Badewannen	87
Masažne kopalne kadi / Masažne kade za kupanje Massage tubs / Massage-Badewannen	88
Barve sanitarne opreme / Boje sanitarne opreme Sanitary ware colours / Farben der Sanitäreinrichtung	90
Dodatna oprema / Dodatna oprema Accessoires / Zusatzprogramm	93



Pregled ponudbe / Pregled ponude / Our offer / Prüfung des Angebots

Umivalniki / Umivaonici Basins / Waschbecken	122
Ogledala / Ogledala / Mirrors / Spiegel	131
Omarice z ogledali / Ormarići s ogledalima Mirror cabinets / Spiegelschränke	133
Svetilke / Svjetiljke/ Lamps / Leuchten	134
Ročaji / Ručke / Handles / Griffe	135



SESTAVLJENO KOPALNIŠKO POHIŠTVO

Pustite se razvajati. Izberite sestavljeno in dovolite, da vaša kopalnica v le nekaj potezih zablesti v vsem sijaju.

SASTAVLJENI NAMJEŠTAJ ZA KUPAONICE

Ugodite sebi. Odaberite sestavljeno i dopustite da vaša kupaonica u samo nekoliko poteza zablista u svojem sjaju.



Modern trend08

New classic
romance 48

Standard beauty .. 66

ASSEMBLED BATHROOM FURNITURE

Let yourself be pampered. Select the assembled elements and let your bathroom shine in all its beauty in just a few steps.

BADEZIMMER – MODULARE MÖBEL

Lassen Sie sich verwöhnen. Wählen Sie die modulare Möbel, und Ihr Badezimmer wird sich im Handumdrehen in aller Pracht zeigen.

M O D E R N



Čiste linije in izbrane barvne kombinacije rišejo prostor modernega navdiha in drznih idej.

Čiste linije i odabrane kombinacije boja crtaju prostor moderne inspiracije i smjelih ideja.

T R E N D



Clean lines and selected colour combinations design space of modern inspiration and bold ideas.

Klare Linien und ausgewählte Farbkombinationen zeichnen den Raum der modernen Inspiration und kühnen Ideen.



Kuba10



Vega 18



Jazz 22



Oasis 28



Avon 36



Slim 44

KUBA





▲ **Kopalniško pohištvo:**

- Vrata: bela visok sijaj
- Obod: metalno srebrn

Barva sanitarne opreme:

- DOLOPOL BISER

Namještaj za kupaonice:

- Vrata: bijela visoki sjaj
- Obod: metalnosrebrna

Boja sanitarne opreme:

- DOLOPOL BISER

Bathroom cabinets:

- Door: white high gloss
- Body: silver metallic

Sanitary ware colour:

- DOLOPOL BISER

Badezimmermöbel:

- Front: Weiß Hochglanz
- Korpus: Metallfarbe Silber

Farbe der Sanitäreinrichtung:

- DOLOPOL BISER

KUBA





▲ **Kopalniško pohištvo:**

- Vrata: črna visok sijaj
- Obod: metalno bron

Barva sanitarne opreme:

- DOLOPOL BISER

Namještaj za kupaonice:

- Vrata: crna visoki sjaj
- Obod: metalnobrončana

Boja sanitarne opreme:

- DOLOPOL BISER

Bathroom cabinets:

- Door: black high gloss
- Body: bronze metallic

Sanitary ware colour:

- DOLOPOL BISER

Badezimmermöbel:

- Front: Schwarz Hochglanz
- Korpus: Metallfarbe Bronze

Farbe der Sanitäreinrichtung:

- DOLOPOL BISER

KUBA



▲ Kopalniško pohištvo:

- Vrata: črna visok sijaj
- Obod: metalno srebrn
- Barva sanitarne opreme:**
- DOLOPOL BISER

Namještaj za kupaonice:

- Vrata: crna visoki sjaj
- Obod: metalnosrebrna
- Boja sanitarne opreme:**
- DOLOPOL BISER

Bathroom cabinets:

- Door: black high gloss
- Body: silver metallic
- Sanitary ware colour:**
- DOLOPOL BISER

Badezimmermöbel:

- Front: Schwarz Hochglanz
- Korpus: Metallfarbe Silber
- Farbe der Sanitäreinrichtung:**
- DOLOPOL BISER

Vrata / Vrata / Door / Front



bela visok sijaj
bijela, visoki sjaj
white high gloss
Weiß Hochglanz

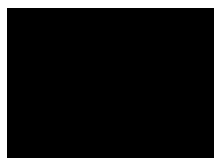

črna visok sijaj
crna visoki sjaj
black high gloss
Schwarz Hochglanz

- **Vrata:** oplašćena vlaknena plošća (MDF) v visokem sijaju: bela, črna
- **Vrata:** obložena vlaknatica (MDF) u visokome sjaju: bijela, crna
- **Door:** foiled fibreboard (MDF) with high-gloss finish: white, black
- **Front:** Faserplatte (MDF) Hochglanz foliert: Weiß, Schwarz
- **Pokrivna plošća:** kaljeno steklo
- **Pokrivna plošća:** kaljeno staklo
- **Top panel:** tempered glass
- **Deckplatte:** gehärtetes Glas

Obod / Obod / Body / Korpus

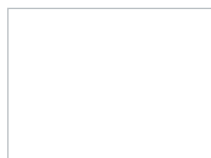

bela visok sijaj
bijela visoki sjaj
white high gloss
Weiß Hochglanz



metalno srebrna
metalnosrebrna
silver metallic
Metallfarbe Silber



metalno bron
metalnobrončana
brunze metallic
Metallfarbe Bronze

- **Obod:**
 - oplašćena vlaknena plošća v visokem sijaju: bela
 - s česanim aluminijem oplemenitena iverna plošća: metalno srebrna, metalno bron
- **Obod :**
 - obložena vlaknatica u visokome sjaju: bijela
 - s češljanim aluminijem oplemenjena iverica: metalnosrebrna, metalnobrončana
- **Body:**
 - foiled fibreboard (MDF) with high-gloss finish: white
 - laminated particle board in aluminium finish: silver metallic, bronze metallic
- **Korpus :**
 - Mit gekämmtem Aluminium veredelte Kunststoffoberfläche: Metallfarbe Silber, Metallfarbe Bronze
 - Faserplatte (MDF) Hochglanz foliert: Weiß

KUBA

Program elementov / Program elemenata / Bathroom furniture / Typenübersicht

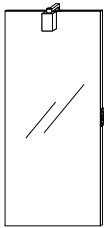

Ogledalo 40 x 100 cm s svetilko
Ogledalo 40 x 100 cm sa svjetiljkom
Mirror 40 x 100 cm with light fitting
Spiegel 40 x 100 cm mit Leuchte
• 40/100/2
126,08 PT*

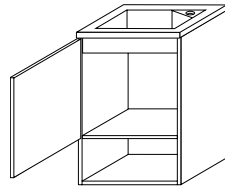

BKG 45. 03 L,D
• Umivaonik UM 45.177
Umivaonik UM 45.177
Basin UM 45.177
Waschbecken UM 45.177
45,2/2/45,2
• Element pod umivaonikom F 45.01 L,D
Element ispod umivaonika F 45.01 L,D
Vanity cabinet F 45.01 L,R
Waschbeckenunterschrank F 45.01 L,R
45/65/45
430,52 PT*

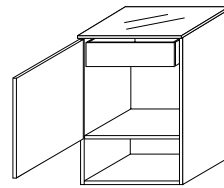

B 45.01 L,D
Spodnji element s skrivenim predalom in
stekleno pokrivno ploščo L,D
Donji element sa sakrivenom ladicom i
staklenom pokrivnom pločom L,D
Base cabinet with concealed drawer and
glass top L,R
Unterschrank mit Innenlade und
Glasdeckplatte L,R
• 45/66/45
389,20 PT*

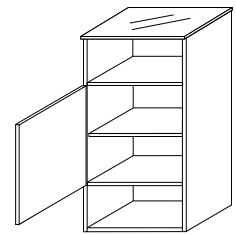

D 45.01 L,D
Spodnji element s stekleno pokrivno
ploščo L,D
Donji element sa staklenom pokrivnom
pločom L,D
Base cabinet with glass top L,R
Unterschrank mit Glasdeckplatte L,R
• 45/86/45
458,80 PT*

Program priporočenih dodatnih elementov / Program preporučljivih dodatnih elemenata Recommended additional cabinets / Programm der empfohlenen Zusatzelemente

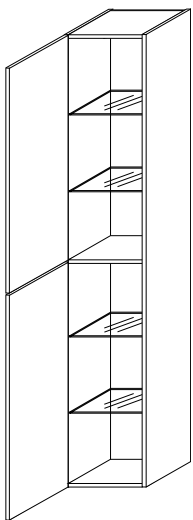

E 30.05 L,D
Omara »svinčnik« L,D
Ormar »olovka« L,D
»Pencil« cabinet L,R
Schrank »Bleistift« L,R
• 30/180/35
257,02 PT*

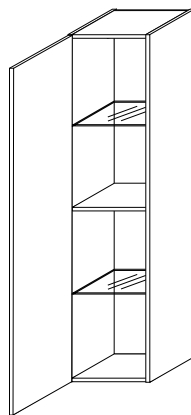

D 30.05 L,D
Omara »svinčnik« L,D
Ormar »olovka« L,D
»Pencil« cabinet L,R
Schrank »Bleistift« L,R
• 30/130/35
235,10 PT*

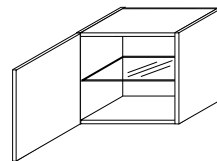

B 45.10 L,D
Kocka L,D
Kocka L,D
Cube L,R
Würfel L,R
• 45/45/18
108,74 PT*



Omara »svinčnik« / Ormar »olovka« »Pencil« cabinet / Schrank »Bleistift«

- **Vrata in obod:** oplasčena vlaknena plošča (MDF) v visokem sijaju: bela, črna
- **Vrata i obod:** obložena vlaknatice (MDF) u visokome sjaju: bijela, crna
- **Door and body:** foiled fibreboard (MDF) with high-gloss finish: white, black
- **Front und Korpus:** Faserplatte (MDF) Hochglanz foliert: Weiß, Schwarz

Kocka / Kocka / Cube / Würfel

- **Vrata in obod:** oplasčena vlaknena plošča (MDF) v visokem sijaju: bela, črna
- **Vrata i obod:** obložena vlaknatice (MDF) u visokome sjaju: bijela, crna
- **Door and body:** foiled fibreboard (MDF) with high-gloss finish: white, black
- **Front und Korpus:** Faserplatte (MDF) Hochglanz foliert: Weiß, Schwarz

KUBA

Program priporočenih dodatnih elementov / Program preporučenih dodatnih elementov
Recommended additional cabinets / Programm der empfohlenen Zusatzelemente

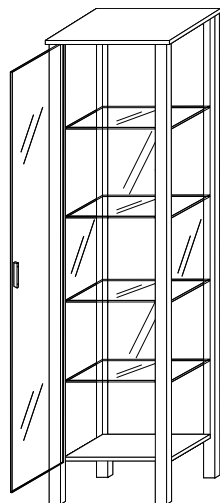

E 45.02 L,D
Steklena vitrina L,D
Staklena vitrina L,D
Glass cabinet L,R
Glasvitrine L,R
• 46,6/181,8/46
415,76 PT *

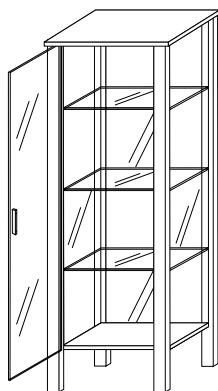

D 45.02 L,D
Steklena vitrina L,D
Staklena vitrina L,D
Glass cabinet L,R
Glasvitrine L,R
• 46,6/131,8/46
318,76 PT *



Steklena vitrina / Staklena vitrina / Glass cabinet / Glasvitrine

Obod:

- vlaknena plošča (MDF) lakirana z visokosijajnim ali mat lakom: bela sijaj, črna sijaj, čokoladno rjava mat

Obod:

- vlaknatica (MDF), lakirana visokosijajnim ili mat lakom: bijela sjaj, crna sjaj, čokoladno smeđa mat

Body:

- fibreboard (MDF) coated with high-gloss or satin lacquer: white gloss, black gloss, chocolate brown matt

Korpus:

- Faserplatte (MDF), lackiert mit Hochglanzlack oder Mattlack: Weiß Hochglanz, Schwarz Hochglanz, Schokoladenbraun Matt

Priporočena sanitarna oprema / Preporučljiva sanitarna oprema
Recommended sanitary ware / Die empfohlene Sanitäreinrichtung

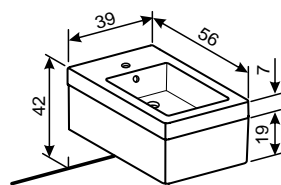

BD 39.28

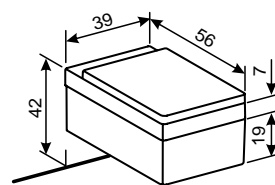

WC 39.28

BD 39.28
Bide Kuba
Bide Kuba
Bidet Kuba
Bidet Kuba
• 39/35,4/56
407,57 PT *

WC 39.28
WC školjka Kuba
WC-školjka Kuba
WC pan Kuba
Toilettenschüssel Kuba
• 39/39,4/56
639,41 PT *

KUBA



KK 185.28

Kopalna kad Kuba

Barve predalov: bela sijaj, črna sijaj, česana smreka rjava

Kada za kupanje Kuba

Boje ladica: bijela sjaj, crna sjaj, češljana smreka smeđa

Bathtub Kuba

Colours of drawers: white gloss, black gloss, spruce brown

Badewanne Kuba

Die Farben der Schubladen: Weiß Glanz, Schwarz Glanz, gekämmte Fichte braun

• 185/57/110,3

1.380,20 PT *

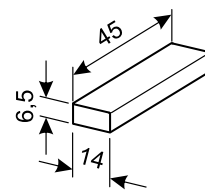

PL 45.185

Polica Julija

Polica Julija

Shelf Julija

Ablage Julija

• 45/6,5/14

65,32 PT *



KT 160.75

Tuš kad Kuba

Tuš-kada Kuba

Shower tray Kuba

Duschwanne Kuba

• 160/6/90

288,88 PT *



Odpiranje tuš kabine Kuba KTK 160.75

Otvaranje tuš-kabine Kuba KT 160.75

Opening of the shower cabin Kuba KT 160.75

Öffnen der Duschkabine Kuba KT 160.75

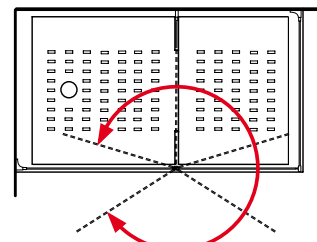

KTK 160.75

Tuš kabina Kuba

Tuš-kabina Kuba

Shower cabin Kuba

Duschkabine Kuba

• 160/190/90

1300,78 PT *

SESTAVLJENO KOPALNIŠKO POHIŠTVO / SASTAVLJENI NAMJEŠTAJ ZA KUPAONICE
ASSEMBLED BATHROOM FURNITURE / BADEZIMMER - MODULARE MÖBEL

VEGA





◀ **Kopalniško pohištvo:**

- Vrata: sliva
- Obod: sliva
- Ročaj: 99.Cr/mat

Barva sanitarne opreme:

- DOLOPOL BISER

Namještaj za kupaonice:

- Vrata: šljiva
- Obod: šljiva
- Ručka: 99.Cr/mat

Boja sanitarne opreme:

- DOLOPOL BISER

Bathroom cabinets:

- Door: plum
- Body: plum
- Handle: 99.Cr/satin

Sanitary ware colour:

- DOLOPOL BISER

Badezimmermöbel:

- Front: Zwetschke
- Korpus: Zwetschke
- Griff: 99.Cr/Matt

Farbe der Sanitäreinrichtung:

- DOLOPOL BISER

VEGA



VEGA

Program elementov / Program elemenata / Bathroom furniture / Typenübersicht



Ogledalo 50x80 cm s svetilko
Ogledalo 50x80 cm sa svjetiljkom
Mirror 50x80 cm with light
Spiegelpaneel mit Leuchte
• 50/80/2
116,63 PT *

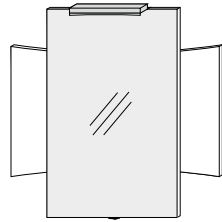

F 80.16
Panel z ogledalom in svetilko
Panel s ogledalom i svjetiljkom
Mirror panel with light
Spiegelpaneel mit Leuchte
• 80/80/3,5
142,31 PT *

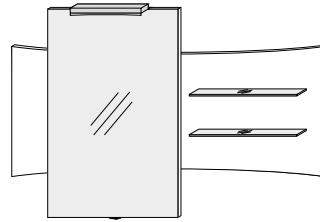

F 120.16 L,D
Panel z ogledalom, svetilko in steklenimi policami L,D
Panel s ogledalom, svjetiljkom i staklenim policama L,D
Mirror panel with light and glass shelves L,R
Spiegelpaneel mit Leuchte und Glasablagen L,R
• 120/80/13
167,33 PT *

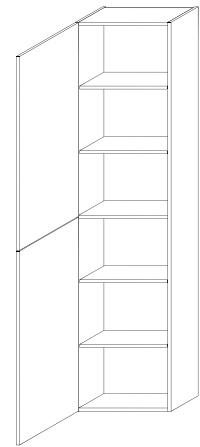

E 40.06 L,D
Visoka omara L,D
Visoki ormar L,D
Tall cabinet L,R
Hochschrank L,R
• 40/163/33
148,72 PT *

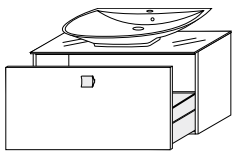

BKG 80.18
• Umivalnik UM 69.136
Umivaonik UM 69.136
Basin UM 69.136
Waschbecken UM 69.136
68,5/12,3/45,2
• Element pod umivalnikom F 80.06
Element ispod umivaonika F 80.06
Vanity cabinet F 80.06
Waschbeckenunterschrank F 80.06
80/40/45,5
• Steklana pokrivna plošča
Staklena pokrovna ploča
Glass top
Glasdeckplatte
80,2/1/46
455,09 PT *

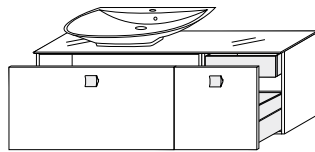

BKG 120.18 L,D
• Umivalnik UM 69.136
Umivaonik UM 69.136
Basin UM 69.136
Waschbecken UM 69.136
68,5/12,3/45,2
• Element pod umivalnikom F 80.06
Element ispod umivaonika F 80.06
Vanity cabinet F 80.06
Waschbeckenunterschrank F 80.06
80/40/45,5
• Spodnji element B 40.06
Donji element B 40.06
Base cabinet B 40.06
40/40/45,5
• Steklana pokrivna plošča L,D
Staklena pokrovna ploča L,D
Glass top L,R
Glasdeckplatte L,R
120,2/1/46
684,46 PT *

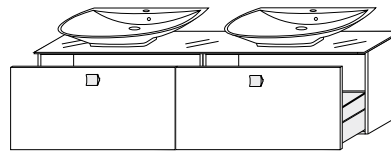

BKG 160.18
• 2x umivalnik UM 69.136
2x umivaonik UM 69.136
2x Basin UM 69.136
2x Waschbecken UM 69.136
68,5/12,3/45,2
• 2x element pod umivalnikom F 80.06
2x element ispod umivaonika F 80.06
2x Vanity cabinet F 80.06
2x Waschbeckenunterschrank F 80.06
80/40/45,5
• Steklana pokrivna plošča
Staklena pokrovna ploča
Glass top
Glasdeckplatte
160,2/1/46
880,34 PT *

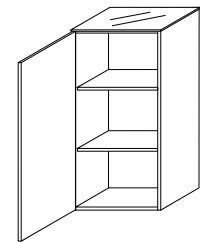

BKG 40.04 L,D
Spodnji element s stekleno pokrivno ploščo L,D
Donji element sa staklenom pokrivnom pločom L,D
Base cabinet with glass top L,R
Unterschrank mit Glasdeckplatte L,R
• 40,2/82,5/34
122,07 PT *

Vrata / Vrata / Door / Front



sliva/sljiva
plum/Zwetschke



bela mat/bijela mat
white satin/Weiß Matt

Vrata:

- Oplemenitena iverna plošča v lesnem dekorju: sliva
- Oplaščena vlaknena plošča (MDF): bela mat

Vrata:

- Oplemenjena iverica u drvenom dekoru: šljiva
- Obložena vlaknatica: bijela mat

Door:

- Laminated particle board, plum
- Foiled fibreboard, white satin

Front:

- Kunststoffoberfläche im Holzdekor Zwetschke
- Beschichtete Faserplatte: Weiß Matt

Obod / Obod / Body / Korpus



sliva/sljiva
plum/Zwetschke

Obod:

- Oplemenitena iverna plošča v lesnem dekorju: sliva

Obod:

- Oplemenjena iverica u drvenom dekoru: šljiva

- **Pokrivna plošča:** kaljeno staklo
- **Pokrivna ploča:** kaljeno staklo

Body:

- Laminated particle board, plum

Korpus:

- Kunststoffoberfläche im Holzdekor Zwetschke

- **Top panel:** tempered glass
- **Deckplatte:** gehärtetes Glas

SESTAVLJENO KOPALNIŠKO POHIŠTVO / SASTAVLJENI NAMJEŠTAJ ZA KUPAONICE
ASSEMBLED BATHROOM FURNITURE / BADEZIMMER - MODULARE MÖBEL

JAZZ





◀ Kopalniško pohištvo:

- Vrata: karbon sijaj
- Obod: karbon sijaj
- Ročaj: 95.02 Alu brušen, črn

Barva sanitarne opreme:

- DOLOPOL BISER

Namještaj za kupaonice:

- Vrata: karbon sjaj
- Obod: karbon sjaj
- Ručka: 95.02 Alu brušena, crna

Boja sanitarne opreme:

- DOLOPOL BISER

Bathroom cabinets:

- Door: carbon gloss
- Body: carbon gloss
- Handle: 95.02 brushed aluminium, black

Sanitary ware colour:

- DOLOPOL BISER

Badezimmermöbel:

- Front: Karbon Glanz
- Korpus: Karbon Glanz
- Griff: 95.02 Alu geschliffen, schwarz

Farbe der Sanitäreinrichtung:

- DOLOPOL BISER

JAZZ





JAZZ

Program elementov / Program elemenata / Bathroom furniture / Typenübersicht

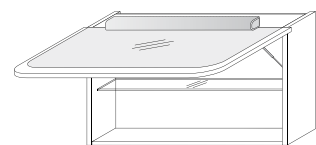

F 70.13
Viseči element z ogledalom in svetilko
Viseči element s ogledalom i svjetiljkom
Wall-mounted mirror cabinet with light fitting
Spiegelschrank mit Leuchte
• 75/40/16
268,10 PT *

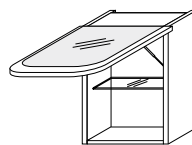

F 35.03
Viseči element z ogledalom
Viseči element s ogledalom
Wall-mounted mirror cabinet
Spiegelschrank
• 35/40/16
80,30 PT *

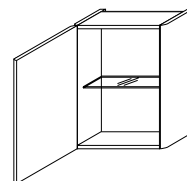

B 35.13 L,D
Viseči element L,D
Viseči element L,D
Wall-mounted cabinet L,R
Wandschrank L,R
• 35/40/16
106,84 PT *

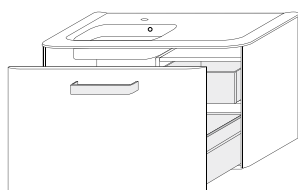

BKG 75.03
• Umivalnik UM 75.145 L
Umivaonik UM 75.145 L
Basin UM 75.145 L
Waschbecken UM 75.145 L
75,7/2,5/50
• Element pod umivalnikom F 75.03
Element ispod umivaonika F 75.03
Vanity cabinet F 75.03
Waschbeckenunterschrank F 75.03
75/40/49,5
• Viseči element z ogledalom in svetilko F 70.13
Viseči element s ogledalom i svjetiljkom F 70.13
Wall-mounted mirror cabinet with light fitting F 70.13
Spiegelschrank mit Leuchte F 70.13
75/40/16
686,32 PT *

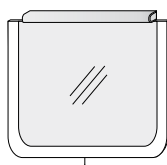

SKG 75.03
Ogledalo 75x75 cm s svetilko
Ogledalo 75x75 cm sa svjetiljkom
Mirror 75x75 cm with light fitting
Spiegel 75x75 cm mit Leuchte
• 75/75/2
222,14 PT *

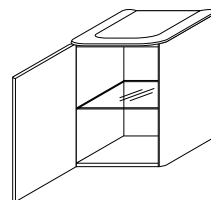

BKG 35.15 L,D
Spodnji element z odlagalno polico iz kompozitnega materiala L,D
Donji element s policom za odlaganje, od kompozitnoga materijala L,D
Base cabinet with functional top made of composite material L,R
Unterschrank mit Ablage aus Kompositmaterial L,R
• 35,6/42,5/33,5
171,37 PT *

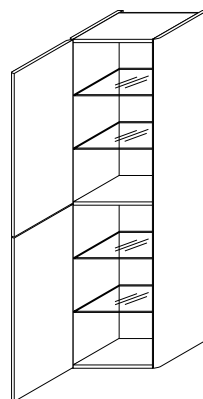

E 35.03 L,D
Visoka omara L,D / Visoki ormar L,D
Tall cabinet L,R / Hochschrank L,R
• 35/145/33
333,06 PT *

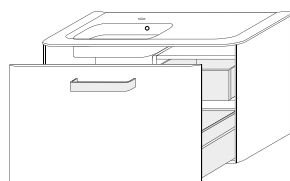

BKG 75.05
• Umivalnik UM 75.145 L
Umivaonik UM 75.145 L
Basin UM 75.145 L
Waschbecken UM 75.145 L
75,7/2,5/50
• Element pod umivalnikom F 75.03
Element ispod umivaonika F 75.03
Vanity cabinet F 75.03
Waschbeckenunterschrank F 75.03
75/40/49,5
418,22 PT *

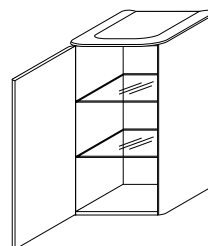

BKG 35.21 L,D
Spodnji element z odlagalno polico iz kompozitnega materiala L,D
Donji element s policom za odlaganje, od kompozitnoga materijala L,D
Base cabinet with functional top made of composite material L,R
Unterschrank mit Ablage aus Kompositmaterial L,R
• 35,6/75/33,5
209,05 PT *

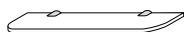

PL 50.01
Polica / Polica
Shelf / Ablage
• 50/1,6/15
24,75 PT *

Vrata in obod:

- Oplaščena vlaknena plošča (MDF): bela mat, rdeča mat, cappuccino mat, oreh sijaj, karbon sijaj

Vrata i obod:

- Obložena vlaknatica (MDF): bijela mat, crvena mat, cappuccino mat, orah sjaj, karbon sjaj

Door and body:

- Foiled fibreboard (MDF): white satin, red satin, cappuccino satin, walnut gloss, carbon gloss

Front und Korpus:

- Faserplatte (MDF): Weiß Matt, rot Matt, Cappuccino Matt, Nuß Glanz, Karbon Glanz



bela mat
bijela mat
white satin
Weiß Matt



rdeča mat
crvena mat
red satin
Rot Matt



cappuccino mat
cappuccino mat
cappuccino satin
Cappuccino Matt



oreh sijaj
orah sjaj
walnut gloss
Nuß Glanz



karbon sijaj
karbon sjaj
carbon gloss
Karbon Glanz

JAZZ SMALL



bela mat / bijela mat / white satin / Weiß Matt



rdeča mat / crvena mat / red satin / Rot Matt



oreh sijaj / orah sjaj / walnut gloss / Nuß Glanz



cappuccino mat / cappuccino mat / cappuccino satin / Cappuccino Matt



karbon sijaj / karbon sjaj / carbon gloss / Karbon Glanz

Program elementov / Program elemenata / Bathroom furniture / Typenübersicht

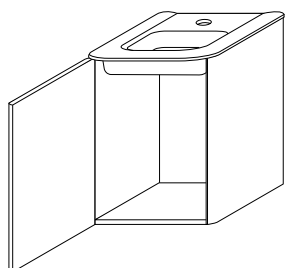

BKG 35.20 L,D

- Umivalnik UM 35.183
Umivaonik UM 35.183
Basin UM 35.183
Waschbecken UM 35.183
35,6/2,5/33,5

- Element pod umivalnikom F 35.02 L,D
Element ispod umivaonika F 35.02 L,D
Vanity cabinet F 35.02 L,R
Waschbeckenunterschrank F 35.02 L,R
35/40/33
208,94 PT *

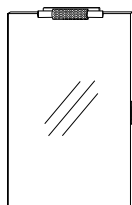

SKG 35.03

- Ogledalo 35x75 cm s svetilko
Ogledalo 35x75 cm sa svjetiljkom
Mirror 35x75 cm with light fitting
Spiegel 35x75 cm mit Leuchte
• 35/75/2
94,44 PT *

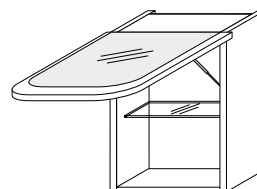

F 35.03

- Viseći element z ogledalom
Viseći element s ogledalom
Wall-mounted mirror cabinet
Spiegelschrank
• 35/40/16
80,30 PT *

OASIS





◀ **Kopalniško pohištvo:**

- Vrata: antracit
- Obod: antracit

Barva sanitarne opreme:

- DOLOPOL BISER

Namještaj za kupaonico:

- Vrata: antracit
- Obod: antracit

Boja sanitarne opreme:

- DOLOPOL BISER

Bathroom cabinets:

- Door: anthracite
- Body: anthracite

Sanitary ware colour:

- DOLOPOL BISER

Badezimmermöbel:

- Front: Anthrazit
- Korpus: Anthrazit

Farbe der Sanitäreinrichtung:

- DOLOPOL BISER

OASIS



Vrata: bela
Obod: sliva

Vrata: bijela
Obod: šljiva

Door: white
Body: plum

Front: Weiß
Korpus: Zwetschke

Harmonija med zaobljenostjo oblik in uporabnostjo notranjosti elementov. Predali so opremljeni s kakovostnimi vodili s polnim izvlekom in mehkim zapiranjem.

Harmonija zaobljenosti oblika i upotrebljivosti unutrašnjosti elemenata. Ladice su opremljene kvalitetnim vodilicama na puno izvlačenje i mekim zatvaranjem.

A symphony of rounded edges and furniture functionality. Drawers feature quality pull-out telescopic sliding rails and soft closing.

Harmonie zwischen Abrundung der Formen und Nutzung der Innenflächen der Elemente. Dazu beitragen auch die Auszüge und Schubkasten mit dem Vollauszug und Weichschließen.



Odlika kopalnice Oasis so zaobljene linije, ki se popolnoma skladajo s sodobnostjo aluminija in gladkimi vrati brez ročajev.

Odlika kupaonice Oasis jesu zaobljene linije koje su u potpunom skladu sa suvremenošću aluminija i glatkim vratima bez ručki.

Oasis is characterised by soft lines, trendy aluminium, and handle- and knob-free doors.

Die Stärke des Badezimmers Oasis sind die abgerundeten Formen, die im vollen Einklang mit dem modern gestalteten Aluminium und den geraden Türen ohne Griff sind.



▲
Vrata in obod: bela

Vrata i obod: bijela

Door and body: white

Front in Korpus: Weiß

OASIS



▲
Vrata: bela
Obod: teak

Vrata: bijela
Obod: teak

Door: white
Body: teak

Front: Weiß
Korpus: Teak



▲
Vrata in obod: antracit
Vrata i obod: antracit
Door and body: anthracite
Front und Korpus: Anthrazit

◀ **Dvojni umivalnik**
 Dvostruki umivaonik
 Double basin
 Doppelwaschbecken

OASIS

Vrata / Vrata
 Door / Front



bela / bijela / white / Weiß

Vrata / Vrata / Door / Front:

- vlaknena plošča (MDF), lakirana z belim mat lakom
- vlaknatica (MDF), lakirana bijelim mat lakom

Vrata / Vrata
 Door / Front



antracit/antracit/anthracite/Anthrazit

Vrata / Vrata / Door / Front:

- vlaknena plošča (MDF), lakirana z mat lakom v antracit barvi
- vlaknatica (MDF), lakirana mat lakom u antracit boji
- varnished fibreboard (MDF), anthracite satin finish
- Faserplatte (MDF), Mattlack, Anthrazit

OASIS BKG 140.51, BKG 140.52

- Vrata: bela
 Obod: sliva
- Vrata: bijela
 Obod: šljiva
- Door: white
 Body: plum
- Front: Weiß
 Korpus: Zwetschke

Obod / Obod / Body / Korpus



bela / bijela / white / Weiß



sliva / šljiva / plum / Zwetschke

- varnished fibreboard (MDF), white satin finish

- Faserplatte (MDF), Mattlack, Weiß



antracit / antracit / anthracite / Anthrazit



teak / teak / teak / Teak

Obod / Obod / Door / Korpus:

- bela oplemenitena iverna plošča, zunanje stene lakirane z mat lakom v beli ali antracit barvi

- oplemenitena iverna plošča v strukturi lesa slive ali dekorju tika
- bijela oplemenjena iverica, vanjske stranice lakirane mat lakom u bijeloj ili antracit boji
- oplemenjena iverica u strukturi drva šljive ili dekoru tika
- white laminated particle board, external panels coated in satin white or anthracite finish
- laminated particle board in plum or teak effect finish
- Kunststoffoberfläche, Außenwände lackiert mit Mattlack Weiß oder Anthrazit
- Kunststoffoberfläche in Holzstruktur Zwetschke oder Teak

Obod / Obod / Body / Korpus



antracit/antracit/anthracite/Anthrazit

Obod / Obod / Body / Korpus:

- bela oplemenitena iverna plošča, zunanje stene lakirane z mat lakom v antracit barvi
- bijela oplemenjena iverica, vanjske stranice lakirane mat lakom u antracit boji
- white laminated particle board, external panels coated in satin anthracite finish
- Kunststoffoberfläche Weiß, Außenwände Mattlack, Anthrazit



▲
 Vrata so brez ročajev - v obod integrirana aluminijasta letev
 Vrata su bez ručki - u obod integrirana aluminijaska letva
 Handle- and knob-free doors with aluminium rail integrated into the body

Tür ohne Griff - im Korpus integrierte Aluminiumleiste

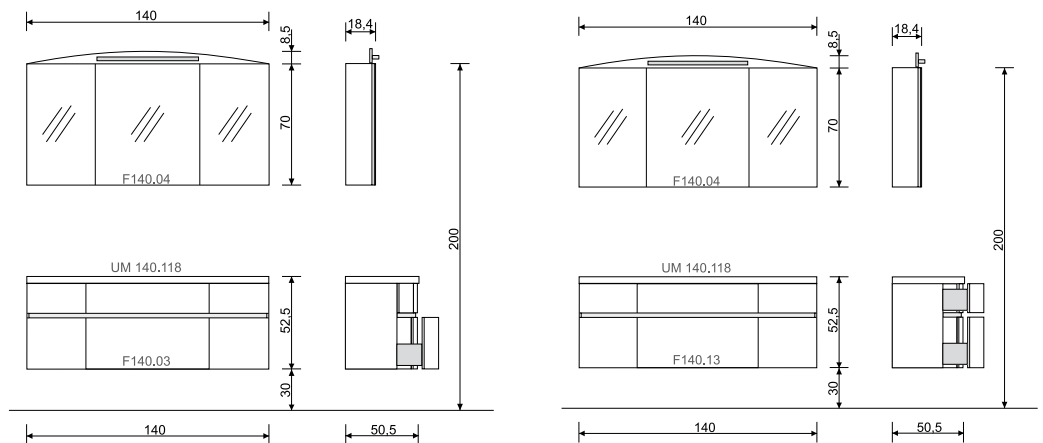

OASIS BKG 140.51

OASIS BKG 140.52

OASIS

Program elementov / Program elemenata / Bathroom furniture / Typenübersicht

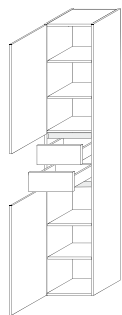

E 30.04 L,D
Visoka omara L,D
Visoki ormar L,D
Tall cabinet L,R
Hochschrank L,R
• 30/180/35
296,43 PT *

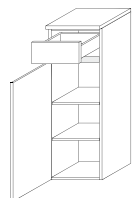

BKG 30.17 L,D
Spodnji element s pokrivno ploščo L,D
Donji element s pokrovnom pločom L,D
Base cabinet with top L,R
Unterschrank mit Deckplatte L,R
• 30/92,8/35
193,78 PT *

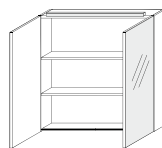

F 70.40
Viseći element z ogledali in svetilko
Viseći element s ogledalima i svjetiljkom
Wall-mounted mirror cabinet with light fitting
Spiegelschrank mit Leuchte
• 70/70/18,4
217,21 PT *

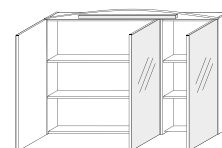

F 105.40 L,D
Viseći element z ogledali in svetilko L,D
Viseći element s ogledalima i svjetiljkom L,D
Wall-mounted mirror cabinet with light fitting L,R
Spiegelschrank mit Leuchte L,R
• 105/70+8,5/18,4
296,39 PT *

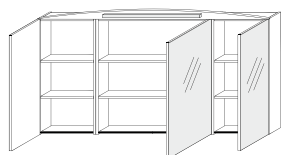

F 140.04
Viseći element z ogledali in svetilko
Viseći element s ogledalima i svjetiljkom
Wall-mounted mirror cabinet with light fitting
Spiegelschrank mit Leuchte
• 140/70+8,5/18,4
347,32 PT *



Ogledalo 70x70cm s svetilko
Ogledalo 70 x70 cm sa svjetiljkom
Mirror 70x70 cm with light fitting
Spiegel 70x70 cm mit Leuchte
• 70/70/2
135,94 PT *



Ogledalo 105x70cm s svetilko
Ogledalo 105 x70 cm sa svjetiljkom
Mirror 105x70 cm with light fitting
Spiegel 105 x70 cm mit Leuchte
• 105/70/2
147,55 PT *



Steklena polica 60 cm
Staklena polica 60 cm
Glass shelf 60 cm
Glasažlabe 60 cm
• 60/0,8/15
12,48 PT *



Steklena polica 90 cm
Staklena polica 90 cm
Glass shelf 90 cm
Glasažlabe 90 cm
• 90/0,8/15
14,55 PT *

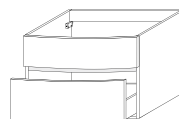

F 70.30
Element pod umivalnikom za umivalnik UM 70.118 / Element pod umivalnikom za umivalnik UM 70.118 / Basin vanity unit UM 70.118 / Waschbeckenunterschrank für Waschbecken UM 70.118
• 70/50/49,5
290,79 PT *

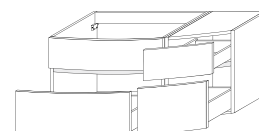

F 105.30 L,D
Element pod umivalnikom za umivalnik UM 105.118 L ali UM 105.118 D / Element ispod umivaonika za umivaonik UM 105.118 L ili UM 105.118 D / Basin vanity unit UM 105.118 L or UM 105.118 R / Waschbeckenunterschrank für Waschbecken UM 105.118 L oder UM 105.118 R
• 105/50/49,5 (35)
494,75 PT *

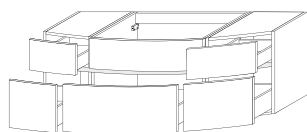

F 140.13
Element pod umivalnikom za umivalnik UM 140.118 (5 predalov)
Element ispod umivaonika za umivaonik UM 140.118 (5 ladica)
Basin vanity unit UM 140.118 (5 drawers)
Waschbeckenunterschrank für Waschbecken UM 140.118 (5 Schubladen)
• 140/50/49,5(35)
696,35 PT *

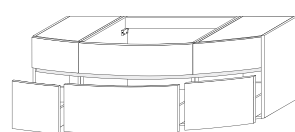

F 140.03
Element pod umivalnikom za umivalnik UM 140.118 (3 predali)
Element ispod umivaonika za umivaonik UM 140.118 (3 ladice)
Basin vanity unit UM 140.118 (3 drawers)
Waschbeckenunterschrank für Waschbecken UM 140.118 (3 Schubladen)
• 140/50/49,5(35)
610,29 PT *

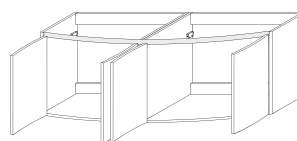

F 140.05
Element pod umivalnikom za umivalnik UM 140.119
Element ispod umivaonika za dvostruki umivaonik UM 140.119
Double basin vanity unit UM 140.119
Waschbeckenunterschrank für Doppelwaschbecken UM 140.119
• 140/50/49,5(35)
434,03 PT *

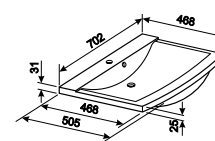

UM 70.118
Umivalnik
Umivaonik
Basin
Waschbecken
116,08 PT *

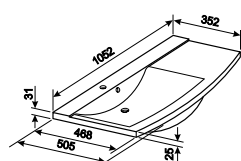

UM 105.118 L
Umivalnik, levi
Umivaonik, lijevi
Basin, left
Waschbecken, links
128,98 PT *

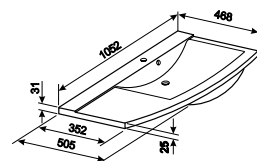

UM 105.118 D
Umivalnik, desni
Umivaonik, desni
Basin, right
Waschbecken, rechts
128,98 PT *

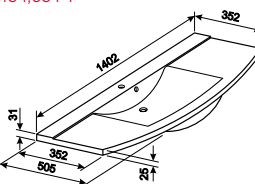

UM 140.118
Umivalnik
Umivaonik
Basin
Waschbecken
152,45 PT *

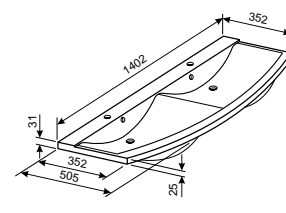

UM 140.119
Umivalnik, dvojni
Umivaonik, dvostruki
Basin, double
Waschbecken, doppelt
175,68 PT *

AVON





◀ **Kopalniško pohištvo:**

- Vrata: črna visok sijaj
- Obod: oreh svetli
- Ročaj: 90.Cr/mat

Barva sanitarne opreme:

- DOLOPOL BISER

Namještaj za kupaonice:

- Vrata: crna visoki sjaj
- Obod: orah svijetli
- Ručka: 90.Cr/mat

Boja sanitarne opreme:

- DOLOPOL BISER

Bathroom cabinets:

- Door: black high gloss
- Body: walnut light
- Handle: 90.Cr/satin

Sanitary ware colour:

- DOLOPOL BISER

Badezimmermöbel:

- Front: Schwarz Hochglanz
- Korpus: Nuß hell
- Griff: 90.Cr/Matt

Farbe der Sanitäreinrichtung:

- DOLOPOL BISER

AVON



▲
Vrata: jabolčno zelena visok sijaj
Obod: wenge

Vrata: jabolčno zelena visoki sjaj
Obod: wenge

Door: apple green, high gloss
Body: wenge

Predali so opremljeni s kakovostnimi vodili s polnim izvlekom in mehkim zapiranjem.

Ladice su opremljene kvalitetnim vodilicama s potpunim izvlačenjem i mekim zatvaranjem.

The drawers are fitted with superior quality, full-extension, soft close guides.

Die Schubkasten zeichnen sich durch den vollen Auszug und den Softeinzug aus.

Front: Apfelgrün, Hochglanz
Korpus: Wenge



►
Vrata: bela visok sijaj
Obod: bela visok sijaj

Vrata: bijela visoki sjaj
Obod: bijela visoki sjaj

Door: white high gloss
Body: white high gloss

Front: Weiß Hochglanz
Korpus: Weiß Hochglanz



- ▲
Vrata: bela visok sijaj
Obod: oreh svetli
Vrata: bijela visoki sjaj
Obod: orah svijetli
Door: white high gloss
Body: walnut light
Front: Weiß
 Hochglanz
Korpus: Nuß hell

AVON



▲
Vrata: črna visok sijaj, **Obod:** bel
Vrata: crna visoki sjaj, **Obod:** bijeli
Door: black high gloss, **Body:** white
Front: Schwarz Hochglanz, **Korpus:** Weiß



- ▲
Vrata: bordo rdeča visok sijaj,
Obod: wenge
Vrata: bordo crvena visoki sjaj,
Obod: wenge
Door: Bordeaux red high gloss
Body: wenge
Front: Bordeaux rot Hochglanz
Korpus: Wenge



- ▲
Vrata: vanilija visok sijaj
Obod: wenge
Vrata: vanilija visoki sjaj,
Obod: wenge
Door: vanilla high gloss
Body: wenge
Front: Vanille Hochglanz
Korpus: Wenge

AVON

Vrata / Vrata / Doors / Frontvarianten

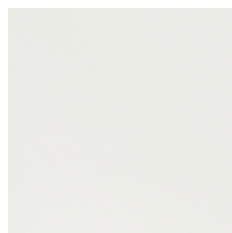

bela visok sijaj
bijela visoki sjaj
white high gloss
Weiß Hochglanz

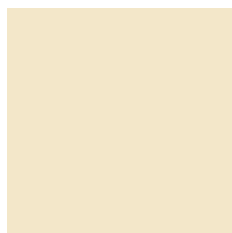

vanilija visok sijaj
vanilija visoki sjaj
vanilla high gloss
Vanille Hochglanz

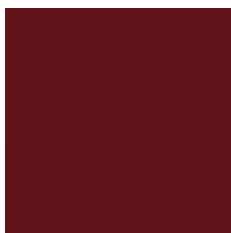

bordo rdeča visok sijaj
bordo crvena visoki sjaj
bordeaux red high gloss
Bordeaux rot Hochglanz



črna visok sijaj
crna visoki sjaj
black high gloss
Schwarz Hochglanz



jabolčno zelena visok sijaj
jabučno zelena visoki sjaj
apple green high gloss
Apfelgrün Hochglanz



oreh svetli, visok sijaj
orah svijetli, visoki sjaj
walnut light, high gloss
Nuß hell, Hochglanz

Vrata:

- oplaščena vlaknena (MDF) plošča v visokem sijaju: bela, vanilija, bordo rdeča, črna
- vlaknena plošča (MDF), lakirana z visokosijajnim lakom: jabolčno zelena
- oplemenitena iverna plošča v strukturi orehovega lesa: orah svetli, visok sijaj

Vrata:

- obložena vlaknatica (MDF) u visokome sjaju: bijela, vanilija, bordo crvena, crna
- vlaknatica (MDF), lakirana visokosijajnim lakom: jabučno zelena
- oplemenjena iverica u strukturi orahovog drveta: orah svijetli, visoki sjaj

Door:

- foiled fibreboard (MDF) with high-gloss finish: white, vanilla, bordeaux red, black
- fibreboard (MDF) coated with high-gloss lacquer: apple green
- laminated particle board in wood texture: walnut light, high gloss

Front:

- Faserplatte (MDF) Hochglanz foliert: Weiß, Vanille, Bordeaux rot, Schwarz
- Faserplatte (MDF), lackiert mit Hochglanzlack: Apfelgrün
- Kunststoffoberfläche in Holzstruktur Nuß hell, Hochglanz



Obod / Obod / Cabinet body / Korpus

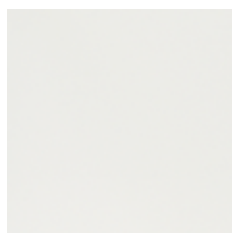

bela / bijela
white / Weiß

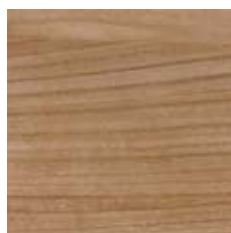

oreh svetli / orah svijetli
walnut light / Nuß hell

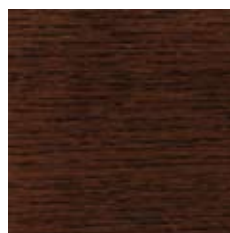

wenge / wenge
wenge / Wenge

- Umivalnik po meri omogoča individualno določitev širine umivalnika v razponu od 90 do 210 cm.

Umivaonik po mjeri omogućava individualno određivanje širine umivaonika u rasponu od 90 do 210 cm.

The made-to-measure basin allows for individual choices of width between 90 and 210 cm.

Waschbecken nach Maß ermöglicht individuelle Einstellung der Waschbeckenbreite von 90 bis 210 cm.

Obod:

- bela oplemenitena iverna plošča, zunanje stene lakirane z visokosijajnim lakom
- oplemenitena iverna plošča v strukturi svetlega orehovega lesa
- furnirana iverna plošča: lužen hrast wenge

Obod:

- bijela oplemenjena iverica, vanjske stranice lakirane visokosijajnim lakom
- oplemenjena iverica u strukturi svijetlog orahovog drveta
- furnirana iverica: luženi hrast wenge

Body:

- white laminated particle board, external panels coated in high gloss finish
- laminated particle board in light walnut wood structure
- particle board oak veneered and wenge varnished

Korpus:

- Kunststoffoberfläche Weiß, Außenwände mit Hochglanzlack
- Kunststoffoberfläche Nuß hell
- furnierte Spanplatte: gelaugte Eiche wenge

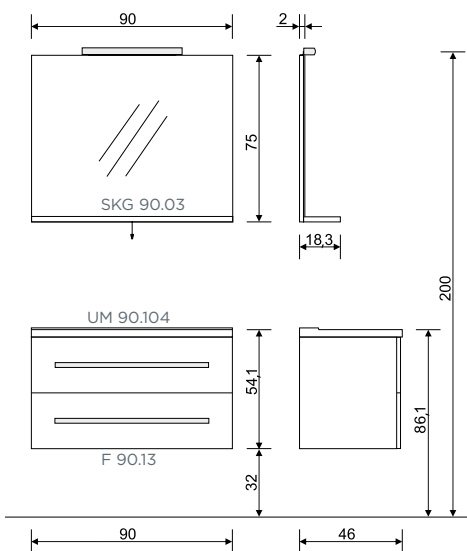

AVON BKG 90.17

Vrata: bela, črna, jabolčno zelena visok sijaj

Obod: orah svetli

Vrata: bijela, crna, jabučno zelena visoki sjaj

Obod: orah svijetli

Door: white, black, apple green high gloss

Body: walnut light

Front: Weiß, Schwarz, Apfelgrün Hochglanz

Korpus: Nuß hell

AVON BKG 90.17

AVON

Program elementov / Program elemenata / Bathroom furniture / Typenübersicht

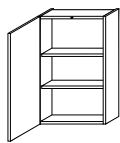

B 45.07 L,D
Viseči element L,D
Viseči element L,D
Wall cabinet L,R
Wandschrank L,R
• 45/75/20
101,59 PT *

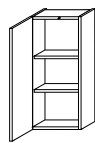

B 30.07 L,D
Viseči element L,D
Viseči element L,D
Wall cabinet L,R
Wandschrank L,R
• 30/75/20
85,59 PT *

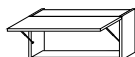

B 60.01
Viseči element
Viseči element
Wall cabinet
Wandschrank
• 60/30/20
100,35 PT *

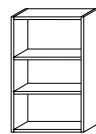

F 45.02
Viseči element s policama
Viseči element s policama
Wall cabinet with shelves
Wandelement mit Ablagen
• 45/75/18
71,29 PT *

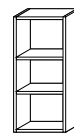

F 30.02
Viseči element s policama
Viseči element s policama
Wall cabinet with shelves
Wandelement mit Ablagen
• 30/75/18
62,08 PT *

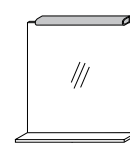

SKG 60.03
Ogledalo s policom i svetiljko
Ogledalo s policom i svetiljkom
Mirror with shelf and lamp
Spiegel mit Ablage und Leuchte
• 60/75/18,3
187,72 PT *

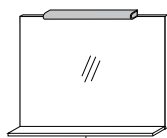

SKG 90.03
Ogledalo s policom i svetiljko
Ogledalo s policom i svetiljkom
Mirror with shelf and lamp
Spiegel mit Ablage und Leuchte
• 90/75/18,3
196,35 PT *

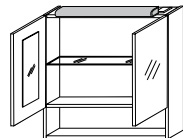

F 60. 02
Element z ogledali in svetiljko
Element s ogledalima i svetiljkom
Wall cabinet with mirrors and lamp
Spiegelschrank mit Leuchte
• 60/75/20
234,96 PT *

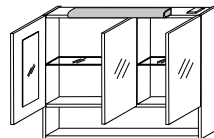

F 90. 22
Element z ogledali in svetiljko
Element s ogledalima i svetiljkom
Wall cabinet with mirrors and lamp
Spiegelschrank mit Leuchte
• 90/75/20
271,06 PT *

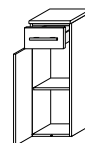

BKG 30.16 L,D
Spodnji element s pokrivno ploščo L,D
Donji element s pokrovnom pločom L,D
Base cabinet with functional top L,R
Unterschrank mit Deckplatte L,R
• 30,2/92,8/36
175,72 PT *

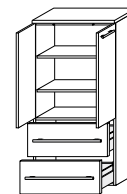

BKG 60.18
Visoka omara s pokrivno ploščo
Visoki ormar s pokrovnom pločom
Tall cabinet with functional top
Hochschrank mit Deckplatte
• 60,2/127,8/36
362,12 PT *

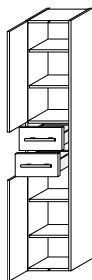

E 30.02 L,D
Visoka omara L,D
Visoki ormar L,D
Tall cabinet L,R
Hochschrank L,R
• 30/180/35
307,03 PT *

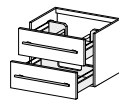

F 60.71
Element pod umivalnikom
Element ispod umivaonika
Vanity cabinet
Waschbeckenunterschrank
• 60/50/45
211,77 PT *

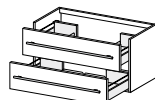

F 90.13
Element pod umivalnikom
Element ispod umivaonika
Vanity cabinet
Waschbeckenunterschrank
• 90/50/45
283,10 PT *

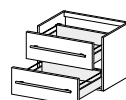

F 60.70
Spodnji element
Donji element
Base cabinet
Unterschrank
• 60/50/45
233,22 PT *

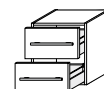

F 45.01
Spodnji element
Donji element
Base cabinet
Unterschrank
• 45/50/45
225,25 PT *



F 30.01
Spodnji element
Donji element
Base cabinet
Unterschrank
• 30/50/45
196,08 PT *

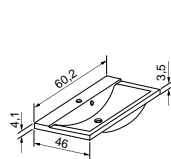

UM 60.181
Umivalnik
Umivaonik
Basin
Waschbecken
102,45 PT *

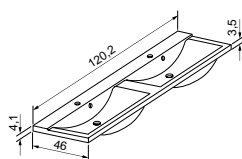

UM 120.182
Umivalnik, dvojni
Umivaonik, dvostruki
Basin, double
Waschbecken, doppelt
164,21 PT *

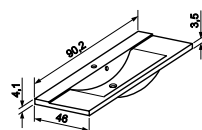

UM 90.104
Umivalnik
Umivaonik
Basin
Waschbecken
126,65 PT *

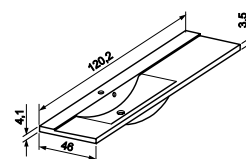

UM 120.104 L
Umivalnik, levi
Umivaonik, lijevi
Basin, left
Waschbecken, links
143,71 PT *

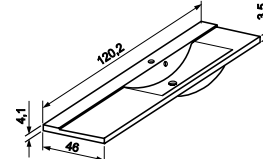

UM 120.104 D
Umivalnik, desni
Umivaonik, desni
Basin, right
Waschbecken, rechts
143,71 PT *

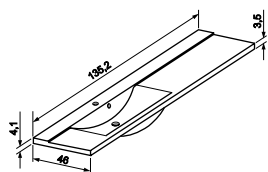

UM 135.104 L
Umivalnik, levi
Umivaonik, lijevi
Basin, left
Waschbecken, links
151,07 PT *

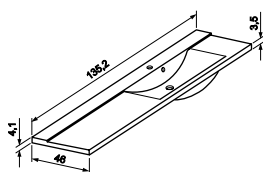

UM 135.104 D
Umivalnik, desni
Umivaonik, desni
Basin, right
Waschbecken, rechts
151,07 PT *

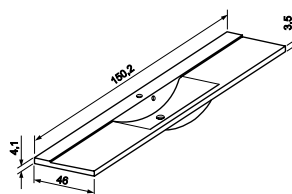

UM 150.104
Umivalnik
Umivaonik
Basin
Waschbecken
158,88 PT *

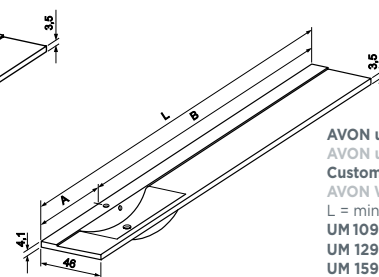

AVON umivalnik po meri
AVON umivaonik po mjeri
Custom-made basin AVON
AVON Waschbecken nach Maß
L = min 90 - max 210 cm
UM 109.109
UM 129.109
UM 159.109
UM 189.109
UM 210.109
261,33 - 312,72 PT *

* Cena v točkah / Cijena u točkama / Price in points / Preis in Punkten

SLIM





Globina umivalnika SLIM je samo 36 cm!
Odlično za majhne kopalnice.

Dubina umivaonika SLIM iznosi samo 36 cm!
Odlično za male kupaonice.

The depth of the SLIM basin is only 36 cm!
Excellent for small bathrooms.

Das Waschbecken SLIM ist nur 36 cm tief!
Hervorragend für kleine Badezimmer.



◀ Kopalniško pohištvo:

- Vrata: bela visok sijaj
- Obod: oreh temni
- Ročaj: 105.Ni

Barva sanitarne opreme:

- DOLOPOL BISER

Namještaj za kupaonice:

- Vrata: bela visok sijaj
- Obod: orah tamni
- Ručka: 105.Ni

Boja sanitarne opreme:

- DOLOPOL BISER

Bathroom cabinets:

- Door: white high gloss
- Body: walnut dark
- Handle: 105.Ni

Sanitary ware colour:

- DOLOPOL BISER

Badezimmermöbel:

- Front: Weiß Hochglanz
- Korpus: Nuß dunkel
- Griff: 105.Ni

Farbe der Sanitäreinrichtung:

- DOLOPOL BISER

SLIM



Vrata / Vrata / Door / Front

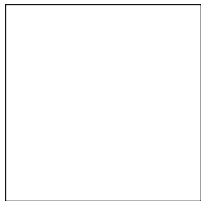

bela visok sijaj
 bijela sjaj
 white gloss
 Weiß Glanz



antracit sijaj
 anthracit sjaj
 anthracite gloss
 Anthrazit Glanz

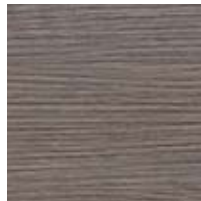

hrast antracit
 hrast antracit
 oak anthracite
 Eiche Anthrazit

Vrata:

- oplasčena vlaknena plošča (MDF) v visokem sijaju: bela
- oplemenitena iverna plošča: antracit sijaj, hrast antracit

Vrata:

- obložena vlaknatica (MDF) u visokome sjaju: bijela
- oplemenjena iverica: antracit sjaj, hrast antracit

Door:

- foiled fibreboard (MDF) with high-gloss finish: white
- laminated particle board: anthracite gloss, oak anthracite

Front:

- Faserplatte (MDF) Hochglanz foliert: Weiß
- Kunststoffoberfläche: Anthrazit Glanz, Eiche Anthrazit

Obod / Obod / Body / Korpus

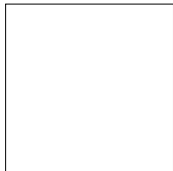

bela sijaj
 bijela sjaj
 white gloss
 Weiß Glanz



oreh temni
 orah tamni
 walnut dark
 Nuß dunkel



antracit sijaj
 anthracit sjaj
 anthracite gloss
 Anthrazit Glanz

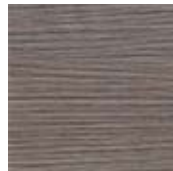

hrast antracit
 hrast antracit
 oak anthracite
 Eiche Anthrazit

Obod:

- oplemenitena iverna plošča: bela sijaj, orah temni, antracit sijaj, hrast antracit

Obod:

- oplemenjena iverica: bijela sjaj, orah tamni, antracit sjaj, hrast antracit

Body:

- Laminated particle board: white gloss, walnut dark, anthracite gloss, oak anthracite

Korpus:

- Kunststoffoberfläche: Weiß Glanz, Nuß dunkel, Anthrazit Glanz, Eiche Anthrazit

Vrata / Vrata / Door / Front

bela sijaj
 bijela sjaj
 white gloss
 Weiß Glanz

antracit sijaj
 anthracit sjaj
 anthracite gloss
 Anthrazit Glanz

hrast antracit
 hrast antracit
 oak anthracite
 Eiche Anthrazit

	bela sijaj bijela sjaj white gloss Weiß Glanz	antracit sijaj anthracit sjaj anthracite gloss Anthrazit Glanz	hrast antracit hrast antracit oak anthracite Eiche Anthrazit
bela sijaj bijela sjaj white gloss Weiß Glanz			
oreh temni orah tamni walnut dark Nuß dunkel			
antracit sijaj anthracit sjaj anthracite gloss Anthrazit Glanz			
hrast antracit hrast antracit oak anthracite Eiche Anthrazit			

SLIM

Program elementov / Program elemenata / Bathroom furniture / Typenübersicht

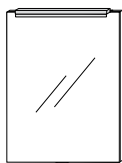

Ogledalo 60x80 cm s svetilko
Ogledalo 60x80 cm sa svjetiljkom
Mirror 60x80 cm with light fitting
Spiegel 60x80 mit Leuchte
• 60/80/2
120,47 PT *

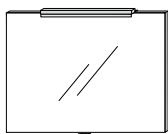

Ogledalo 80x60 cm s svetilko
Ogledalo 80x60 cm sa svjetiljkom
Mirror 80x60 cm with light fitting
Spiegel 80x60 mit Leuchte
• 80/60/2
120,47 PT *

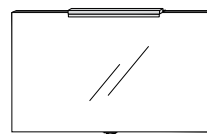

Ogledalo 100x60 cm s svetilko
Ogledalo 100x60 cm sa svjetiljkom
Mirror 100x60 cm with light fitting
Spiegel 100x60 mit Leuchte
• 100/60/2
125,95 PT *

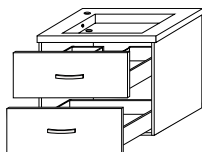

BKG 60.31
• Umivalnik UM 60.120
Umivaonik UM 60.120
Basin UM 60.120
Waschbecken UM 60.120
60,4/5/35,3
• Element pod umivalnikom F 60.05
Element ispod umivaonika F 60.05
Vanity cabinet F 60.05
Waschbeckenunterschrank F 60.05
60/50/35
349,73 PT *

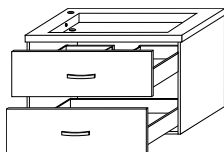

BKG 80.31
• Umivalnik UM 80.120
Umivaonik UM 80.120
Basin UM 80.120
Waschbecken UM 80.120
80,4/5/35,3
• Element pod umivalnikom F 80.05
Element ispod umivaonika F 80.05
Vanity cabinet F 80.05
Waschbeckenunterschrank F 80.05
80/50/35
374,69 PT *

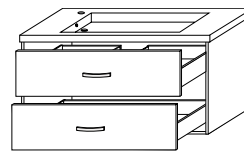

BKG 100.31
• Umivalnik UM 100.120
Umivaonik UM 100.120
Basin UM 100.120
Waschbecken UM 100.120
100,4/5/35,3
• Element pod umivalnikom F 100.05
Element ispod umivaonika F 100.05
Vanity cabinet F 100.05
Waschbeckenunterschrank F 100.05
100/50/35
397,57 PT *

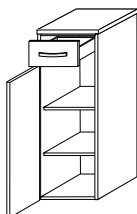

BKG 30.16 L,D
Spodnji element s pokrivno ploščo L,D
Donji element s pokrivnom pločom L,D
Base cabinet with functional top L,R
Unterschrank mit Deckplatte L,R
• 30,3/92,8/36
143,81 PT *

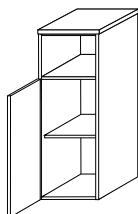

BKG 30.19 L,D
Spodnji element s pokrivno ploščo L,D
Donji element s pokrivnom pločom L,D
Base cabinet with functional top L,R
Unterschrank mit Deckplatte L,R
• 30,3/92,8/36
61,03 PT *

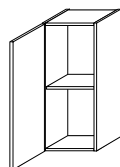

B 30.01 L,D
Viseći element L,D
Viseći element L,D
Wall cabinet L,R
Wandschrank L,R
• 30/60/20
36,92 PT *

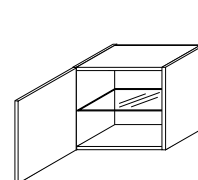

B 45.10 L,D
Kocka L,D
Kocka L,D
Cube L,R
Würfel L,R
• 45/45/18
108,74 PT *

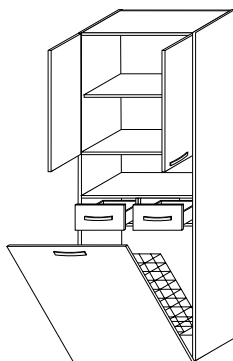

E 60.63
Visoka omara
Visoki ormar
Tall cabinet
Hochschrank
• 60/180/35
375,23 PT *

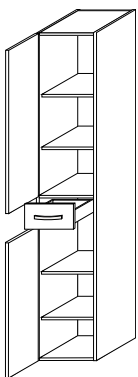

E 30.06 L,D
Visoka omara L,D
Visoki ormar L,D
Tall cabinet L,R
Hochschrank L,R
• 30/180/35
253,43 PT *

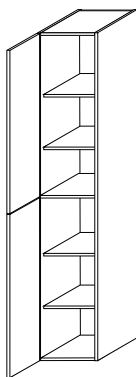

E 30.05 L,D
Visoka omara L,D
Visoki ormar L,D
Tall cabinet L,R
Hochschrank L,R
• 30/180/35
185,87 PT *

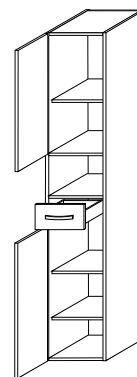

E 30.63 L,D
Visoka omara L,D
Visoki ormar L,D
Tall cabinet L,R
Hochschrank L,R
• 30/180/35
225,05 PT *

NEW CLASSIC



Klasika v luči sodobnih potez pričara brezčasnost ambientsa in
zapelje vsakogar.

Klasika u svjetlu suvremenih poteza dočarava bezvremenost
ambijenta i zavodi svakoga.

R O M A N C E



Markiz 50



Romeo 56



Julija 60

Classic in the light of modern lines evokes the timelessness of the ambience and seduces everyone.

Die Klassik mit modernem Ansatz, welche die Zeitlosigkeit des Ambientes hervorzaubert, lässt keinen unberührt.

MARKIZ



Kopalniško pohištvo:

- obod in prednjika predalov:
česana smreka rjava

Barva sanitarne opreme:

- DOLOPOL BISER

Namještaj za kupaonice:

- obod i fronte ladica:
češljana smreka, smeđa

Boja sanitarne opreme:

- DOLOPOL BISER

Bathroom cabinets:

- body and drawer front panels:
spruce brown

Sanitary ware colour:

- DOLOPOL BISER

Badezimmermöbel:

- Korpus und Ladeblenden:
gekämmte Fichte braun

Farbe der Sanitäreinrichtung:

- DOLOPOL BISER

MARKIZ



▲ **Kopalniško pohištvo:**

- obod in prednjika predalov: česana smreka bela

Barva sanitarne opreme:

- DOLOPOL BISER

Namještaj za kupaonice:

- obod i fronte ladića: češljana smreka bijela

Boja sanitarne opreme:

- DOLOPOL BISER

Bathroom cabinets:

- body and drawer front panels: spruce white

Sanitary ware colour:

- DOLOPOL BISER

Badezimmermöbel:

- Korpus und Ladeblenden: gekämmte Fichte weiß

Farbe der Sanitäreinrichtung:

- DOLOPOL BISER



MARKIZ

Vrata / Vrata / Door / Front



bela visok sijaj
bijela visoki sjaj
white high gloss
Weiß Hochglanz

Vrata:

- Oplaščena vlaknena plošča (MDF) v visokem sijaju: bela
Vrata in predali so brez ročajev (push-pull sistem)

Vrata:

- Obložena vlaknatica (MDF) u visokome sjaju: bijela
Vrata i ladice bez ručki (sustav »push-pull«)

Door:

- Foiled fibreboard (MDF) with high-gloss finish: white
Handle-free doors and drawers (»push-pull« system)

Front:

- Faserplatte (MDF) Hochglanz foliert: Weiß
Tür und Schubladen sind ohne Griffe (»push-pull« System)

Obod in predala / Obod i ladice / Body and drawers / Korpus und Schubladen



smreka česana bela
smreka češljana bijela
spruce white
gekämmte Fichte weiß



smreka česana rjava
smreka češljana smeđa
spruce brown
gekämmte Fichte braun

Obod in prednjika predalov:

- furnirana iverna plošča: česana smreka bela
- oplaščena vlaknena plošča (MDF): česana smreka rjava

Obod i fronte ladica:

- furnirana iverica: smreka češljana bijela
- obložena vlaknatica (MDF): smreka češljana smeđa

Body and drawer front panels:

- veneer particleboard: spruce white
- foiled fibreboard (MDF): spruce brown

Korpus und Ladeblenden:

- Furnierte Spanplatte: gekämmte Fichte weiß
- Beschichtete Faserplatte (MDF): gekämmte Fichte braun

Program elementov / Program elemenata / Bathroom furniture / Typenübersicht

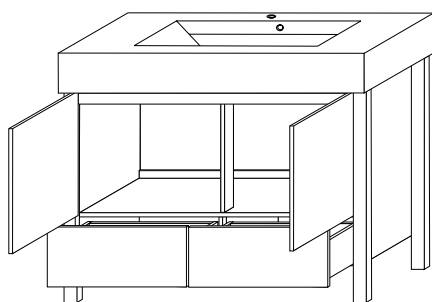

BKG 100.40

- Umivalnik UM 100.179
Umivaonik UM 100.179
Basin UM 100.179
Waschbecken UM 100.179
100,2/12/46
- Element pod umivalnikom F 100.06
Element ispod umivaonika F 100.06
Vanity cabinet F 100.06
Waschbeckenunterschrank F 100.06
99/73/45,5
693,92 PT *

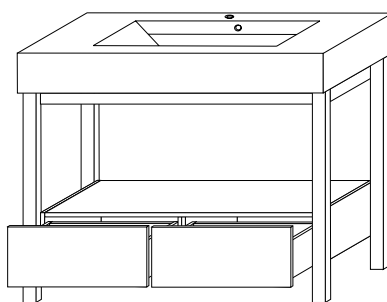

BKG 100.41

- Umivalnik UM 100.179
Umivaonik UM 100.179
Basin UM 100.179
Waschbecken UM 100.179
100,2/12/46
- Element pod umivalnikom F 100.04
Element ispod umivaonika F 100.04
Vanity cabinet F 100.04
Waschbeckenunterschrank F 100.06
99/73/45,5
653,86 PT *

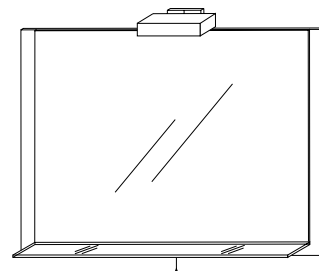

F 100.14

- Ogledalo 100x70 cm s stekleno polico in svetilko
Ogledalo 100 x 70 cm sa staklenom policom i svjetiljkom
Mirror 100 x 70 cm with glass shelf and lamp
Spiegel 100 x 70 cm mit Glasablage und Leuchte
• 100/70/13
258,05 PT *

MARKIZ

Program priporočenih dodatnih elementov / Program preporučenih dodatnih elementa
Recommended additional cabinets / Programm der empfohlenen Zusatzelemente

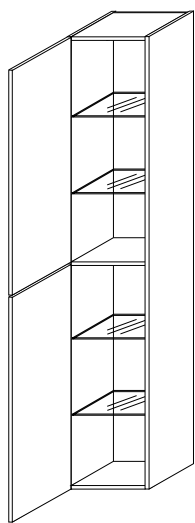

E 30.05 L,D
Omara »svinčnik« L,D
Ormar »olovka« L,D
»Pencil« cabinet L,R
Schrank »Bleistift« L,R
• 30/180/35
257,02 PT *

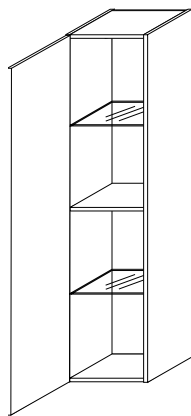

D 30.05 L,D
Omara »svinčnik« L,D
Ormar »olovka« L,D
»Pencil« cabinet L,R
Schrank »Bleistift« L,R
• 30/130/35
235,10 PT *

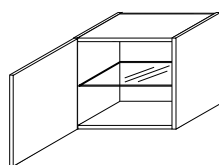

B 45.10 L,D
Kocka L,D
Kocka L,D
Cube L,R
Würfel L,R
• 45/45/18
108,74 PT *

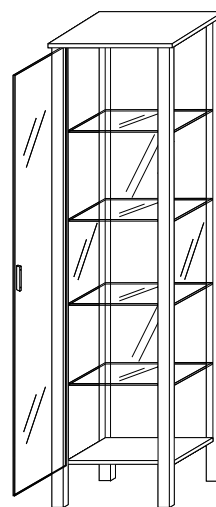

E 45.02 L,D
Steklena vitrina L,D
Staklena vitrina L,D
Glass cabinet L,R
Glasvitrine L,R
• 46,6/181,8/46
415,76 PT *

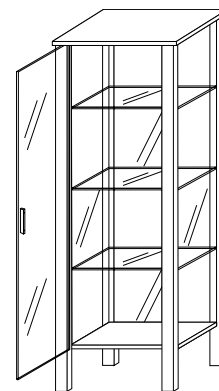

D 45.02 L,D
Steklena vitrina L,D
Staklena vitrina L,D
Glass cabinet L,R
Glasvitrine L,R
• 46,6/131,8/46
318,76 PT *

Omara »svinčnik« / Ormar »olovka« / »Pencil« cabinet / Schrank »Bleistift«

Vrata in obod:

- oplaščena vlaknena plošča (MDF) v visokem sijaju: bela, črna

Vrata i obod:

- obložena vlaknatca (MDF) u visokome sjaju: bijela, crna

Door and body:

- foiled fibreboard (MDF) with high-gloss finish: white, black

Front und Korpus:

- Faserplatte (MDF) Hochglanz foliert: Weiß, Schwarz

Kocka / Kocka / Cube / Würfel

Vrata in obod:

- oplaščena vlaknena plošča (MDF) v visokem sijaju: bela, črna

Vrata i obod:

- obložena vlaknatca (MDF) u visokome sjaju: bijela, crna

Door and body:

- foiled fibreboard (MDF) with high-gloss finish: white, black

Front und Korpus:

- Faserplatte (MDF) Hochglanz foliert: Weiß, Schwarz

Steklena vitrina / Staklena vitrina / Glass cabinet / Glasvitrine

Obod: vlaknena plošča (MDF) lakirana z visokosijajnim ali mat lakom: bela sijaj, črna sijaj, čokoladno rjava mat

Obod: vlaknatca (MDF), lakirana visokosijajnim ili mat lakom: bijela sjaj, crna sjaj, čokoladno smeđa mat

Body: fibreboard (MDF) coated with high-gloss or satin lacquer: white gloss, black gloss, chocolate brown matt

Korpus: Faserplatte (MDF), lackiert mit Hochglanzlack oder Mattlack: Weiß Hochglanz, Schwarz Hochglanz, Schokoladenbraun Matt

MARKIZ

Priporočena sanitarna oprema / Preporučljiva sanitarna oprema
Recommended sanitary ware / Die empfohlene Sanitäreinrichtung



KK 185.28

Kopalna kad Kuba
Barve predalov: bela sijaj, črna sijaj, česana smreka rjava
Kada za kupanje Kuba
Boje ladic: bijela sjaj, crna sjaj, češljana smreka smeđa
Bathtub Kuba
Colours of drawers: white gloss, black gloss, spruce brown
Badewanne Kuba
Die Farben der Schubladen: Weiß Glanz, Schwarz Glanz, gekämmte Fichte braun
• 185/57/110,3
1.380,20 PT *



BD 39.28

Bide Kuba
Bide Kuba
Bidet Kuba
Bidet Kuba
• 39/35,4/56
407,57 PT *

WC 39.28

WC školjka Kuba
WC školjka Kuba
WC pan Kuba
Toilettenschüssel
Kuba
• 39/39,4/56
639,41 PT *



PL 45.185

Polica Julija
Polica Julija
Shelf Julija
Ablage Julija
Kuba
• 45/6,5/14
65,32 PT *

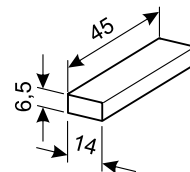

KT 160.75

Tuš kad Kuba
Tuš-kada Kuba
Shower tray Kuba
Duschwanne Kuba
• 160/6/90
288,88 PT *

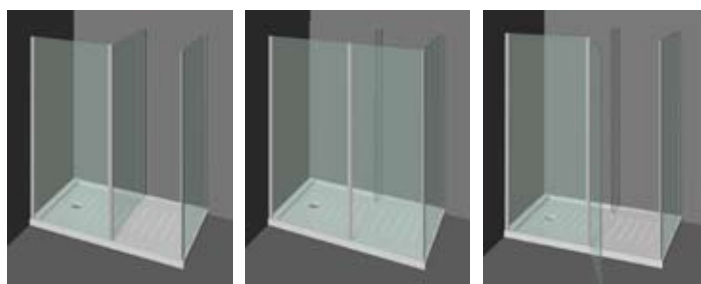

Odpiranje tuš kabine Kuba KTK 160.75
Otvaranje tuš-kabine Kuba KT 160.75
Opening of the shower cabin Kuba KT 160.75
Öffnen der Duschkabine Kuba KT 160.75

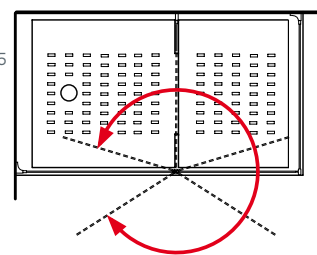

KTK 160.75

Tuš kabina Kuba
Tuš-kabina Kuba
Shower cabin Kuba
Duschkabine Kuba
• 160/190/90
1300,78 PT *

ROMEO





◀ **Kopalniško pohištvo:**

- Vrata: hrast črna patinirana
- Obod: hrast črna
- Ročaj: 107. srebrno patiniran

Barva sanitarne opreme:

- DOLOPOL BISER

Namještaj za kupaonice:

- Vrata: Hrast crna patinirana
- Obod: Hrast crna
- Ručka: 107. srebrno patinirana

Boja sanitarne opreme:

- DOLOPOL BISER

Bathroom cabinets:

- Door: Oak black patina
- Body: Oak black
- Handle: 107. silver patina

Sanitary ware colour:

- DOLOPOL BISER

Badezimmermöbel:

- Front: Eiche schwarz patiniert
- Korpus: Eiche schwarz
- Griff: 107. Silber patiniert

Farbe der Sanitäreinrichtung:

- DOLOPOL BISER



ROMEO



Kopalniško pohištvo:

- Vrata: hrast vanilija patinirana
- Obod: hrast vanilija patinirana
- Ročaj: 107. srebrno patiniran

Barva sanitarne opreme:

- DOLOPOL BISER

Namještaj za kupaonice:

- Vrata: hrast vanilija patinirana
- Obod: hrast vanilija patinirana
- Ručka: 107. srebrno patinirana

Boja sanitarne opreme:

- DOLOPOL BISER

Bathroom cabinets:

- Door: oak vanilla patina
- Body: oak vanilla patina
- Handle: 107. silver patina

Sanitary ware colour:

- DOLOPOL BISER

Badezimmermöbel:

- Front: Eiche vanille patiniert
- Korpus: Eiche vanille patiniert
- Griff: 107. Silber patiniert

Farbe der Sanitäreinrichtung:

- DOLOPOL BISER

Vrata / Vrata / Door / Front:



hrast vanilija patinirana
hrast vanilija patinirana
oak vanilla patina
Eiche vanille patiniert



hrast črna patinirana
hrast črna patinirana
oak black patina
Eiche schwarz patiniert

Obod / Obod / Body / Korpus:

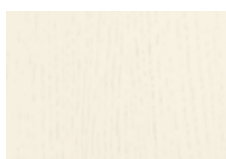

hrast vanilija
hrast vanilija
oak vanilla
Eiche vanille



hrast črna
hrast črna
oak black
Eiche schwarz

Vrata:

- Okvir in polnilo masiven hrastov les, debelina vrat 20 mm

Vrata:

- Okvir i punilo hrastovo drvo, debljina vrata 20 mm

Door:

- Frame and centre panel in oak wood, door thickness 20 mm

Front:

- Massives Eichenholz mit massiver Füllung, 20 mm stark

Obod:

- Furnirana iverna plošča: hrast vanilija, hrast črna

Obod:

- Furnirana iverica: hrast vanilija, hrast črna

Body:

- Veneer particle board: oak vanilla, oak black

Korpus:

- Furnierte Spanplatte: Eiche vanille, Eiche schwarz

Pokrivna plošča:

- iz kompozitnega materiala, debeline 2 cm, odporna na vodo in madeže

Pokrivna ploča:

- od kompozitnoga materijala, debljine od 2 cm, otporna na vodu i mrlje

Top panel:

- made of composite material, 2 cm thick, water and stain resistant

Deckplatte:

- aus Kompositmaterial, Dicke 2 cm, wasser- und fleckenbeständig

Program elementov / Program elemenata / Bathroom furniture / Typenübersicht

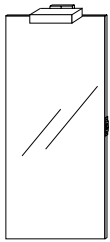

Ogledalo 40x100 cm s svetilko
Ogledalo 40x100 cm sa svjetiljkom
Mirror 40x100 cm with light fitting
Spiegel 40x100 cm mit Leuchte
• 40/100/2
160,12 PT *

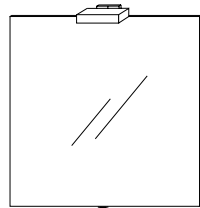

Ogledalo 80x80 cm s svetilko
Ogledalo 80x80 cm sa svjetiljkom
Mirror 80x80 cm with light fitting
Spiegel 80x80 cm mit Leuchte
• 80/80/2
173,76 PT *

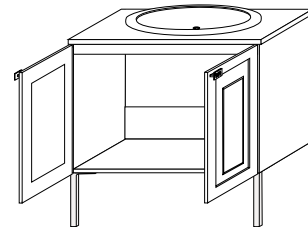

BKG 80.40
80,4/81,6 (61,6)/46,2

- BKG 80.40**
- Umivalnik UM 58.187
Umivaonik UM 58.187
Basin UM 58.187
Waschbecken UM 58.187
57,6/2/41,7
 - Pokrivna plošča POUM 80.40 z izrezom za umivalnik
Pokrovna ploča POUM 80.40 s izrezom za umivaonik

- Countertop POUM 80.40 with basin cut-out
Deckplatte POUM 80.40 mit Ausschnitt für Waschbecken 80,4/2/46,2
- Element pod umivalnikom F 80.08
Element ispod umivaonika F 80.08
Vanity cabinet F 80.08
Waschbeckenunterschrank F 80.08
80/77,6 (57,6)/45
703,06 PT *

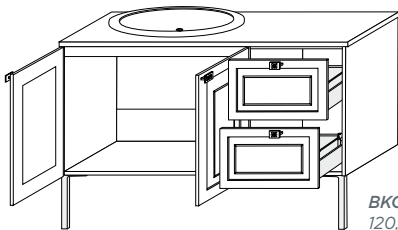

BKG 120.40 L,D
120,4/81,6 (61,6)/46,2

- BKG 120.40 L,D**
- Umivalnik UM 58.187
Umivaonik UM 58.187
Basin UM 58.187
Waschbecken UM 58.187
57,6/2/41,7
 - Pokrivna plošča POUM 120.40 L,D z izrezom za umivalnik
Pokrovna ploča POUM 120.40 L,D s izrezom za umivaonik

- Countertop POUM 120.40 L,R with basin cut-out
Deckplatte POUM 120.40 L,R mit Ausschnitt für Waschbecken 120,4/2/46,2
- Element pod umivalnikom F 120.08
Element ispod umivaonika F 120.08
Vanity cabinet F 120.08
Waschbeckenunterschrank F 120.08
120/77,6 (57,6)/45
1.185,60 PT *

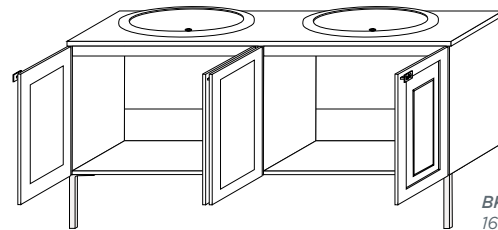

BKG 160.40
160,4/81,6 (61,6)/46,2

- BKG 160.40**
- Umivalnik UM 58.187/2x
Umivaonik UM 58.187/2x
Basin UM 58.187/2x
Waschbecken UM 58.187/2x
57,6/2/41,7
 - Pokrivna plošča POUM 160.41 z izrezom (2x) za umivalnik
Pokrovna ploča POUM 160.41 s izrezom (2x) za umivaonik

- Countertop POUM 160.41 with basin cut-out (2x)
Deckplatte POUM 160.41 mit Ausschnitt (2x) für Waschbecken 160,4/2/46,2
- Element pod umivalnikom F 80.08/2x
Element ispod umivaonika F 80.08/2x
Vanity cabinet F 80.08/2x
Waschbeckenunterschrank F 80.08/2x
160/77,6 (57,6)/45
1.260,14 PT *

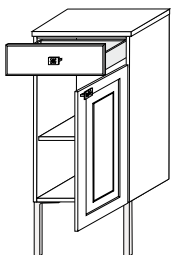

- BKG 40.40 D,L**
Spodnji element s pokrivo ploščo D,L
Donji element s pokrivnom pločom D,L
Base cabinet with functional top R,L
Unterschrank mit Deckplatte R,L
• 40,4/94 (74)/36,2
525,40 PT *

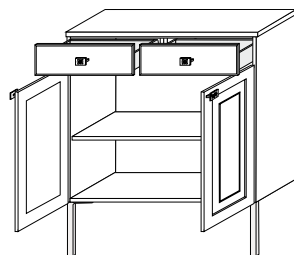

- BKG 80.41**
Spodnji element s pokrivo ploščo
Donji element s pokrivnom pločom
Base cabinet with functional top
Unterschrank mit Deckplatte
• 80,4/94 (74)/36,2
854,50 PT *

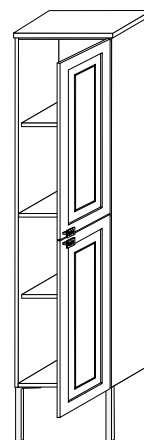

- BKG 40.41 D,L**
Visoka omara s pokrivo ploščo D,L
Visoki ormar s pokrivnom pločom D,L
Tall cabinet with functional top R,L
Hochschrank mit Deckplatte R,L
• 40,4/166 (146)/36,2
704,22 PT *

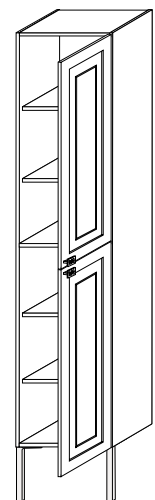

- E 40.02 D,L**
Visoka omara D,L
Visoki ormar D,L
Tall cabinet R,L
Hochschrank R,L
• 40/207,2 (187,2)/35
718,02 PT *

JULIJA





▲ **Sanitarna oprema:**
• DOLOPOL BISER

Sanitarna oprema:
• DOLOPOL BISER

Sanitary ware:
• DOLOPOL BISER

Sanitäreinrichtung:
• DOLOPOL BISER

JULIJA



Program elementov / Program elemenata / Bathroom furniture / Typenübersicht

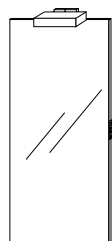

Ogledalo 40x100 cm s svetilko
 Ogledalo 40x100 cm sa svjetiljkom
Mirror 40x100 cm with light fitting
 Spiegel 40x100 cm mit Leuchte
 • 40/100/2
 160,12 PT *

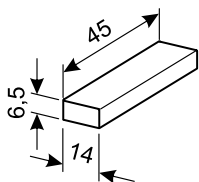

PL 45.185
 Polica Julija
 Polica Julija
 Shelf Julija
 Ablage Julija
 • 45/6,5/14
 65,32 PT *

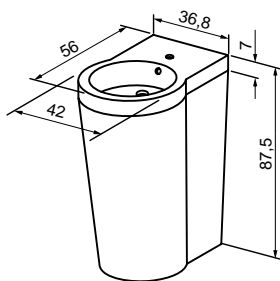

UM 42.185
 Umivalnik Julija
 Umivaonik Julija
 Basin Julija
 Waschbecken Julija
 • 42/87,5/56
 263,08 PT *

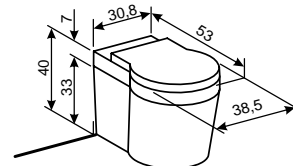

WC 39.27
 WC školjka Julija
 WC školjka Julija
 Toilet bowl Julija
 Toilettenschüssel Julija
 • 38,5/43,5/53
 531,76 PT *

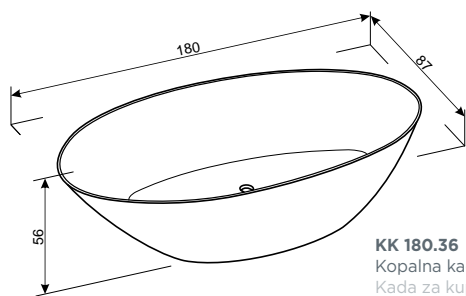

KK 180.36
 Kopalna kad Julija
 Kada za kupanje Julija
 Bathtub Julija
 Badewanne Julija
 • 180/56/87
 1.095,32 PT *

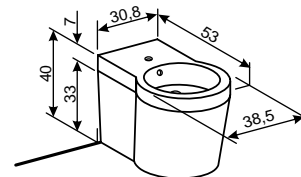

BD 39.27
 Bide Julija
 Bide Julija
 Bidet Julija
 Bidet Julija
 • 38,5/40/53
 337,92 PT *

JULIJA

Program priporočenih dodatnih elementov / Program preporočljivih dodatnih elementov
Recommended additional cabinets / Programm der empfohlenen Zusatzelemente

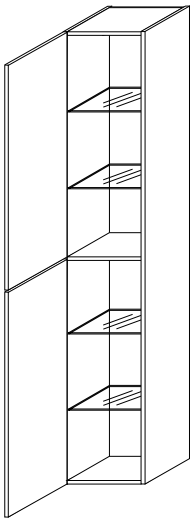

E 30.05 L,D
Omara »svinčnik« L,D
Ormar »olovka« L,D
»Pencil« cabinet L,R
Schrank »Bleistift« L,R
• 30/180/35
257,02 PT *

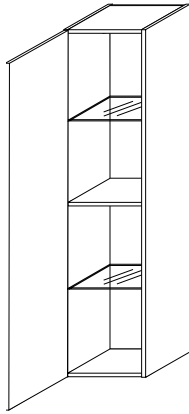

D 30.05 L,D
Omara »svinčnik« L,D
Ormar »olovka« L,D
»Pencil« cabinet L,R
Schrank »Bleistift« L,R
• 30/130/35
235,10 PT *

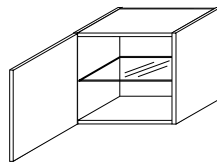

B 45.10 L,D
Kocka L,D
Kocka L,D
Cube L,R
Würfel L,R
• 45/45/18
108,74 PT *

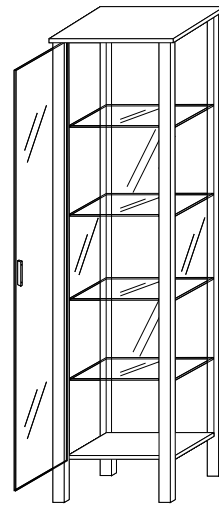

E 45.02 L,D
Steklena vitrina L,D
Staklena vitrina L,D
Glass cabinet L,R
Glasvitrine L,R
• 46,6/181,8/46
415,76 PT *

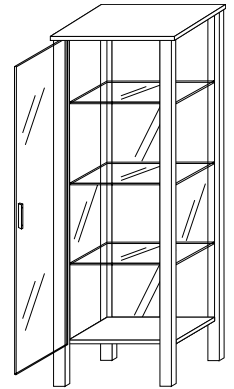

D 45.02 L,D
Steklena vitrina L,D
Staklena vitrina L,D
Glass cabinet L,R
Glasvitrine L,R
• 46,6/131,8/46
318,76 PT *

Omara »svinčnik« / Ormar »olovka« / »Pencil« cabinet / Schrank »Bleistift«

Vrata in obod:

- oplaščena vlaknena plošča (MDF) v visokem sijaju: bela, črna

Vrata i obod:

- obložena vlaknatca (MDF) u visokome sjaju: bijela, crna

Door and body:

- foiled fibreboard (MDF) with high-gloss finish: white, black

Front und Korpus:

- Faserplatte (MDF) Hochglanz foliert: Weiß, Schwarz

Kocka / Kocka / Cube / Würfel

Vrata in obod:

- oplaščena vlaknena plošča (MDF) v visokem sijaju: bela, črna

Vrata i obod:

- obložena vlaknatca (MDF) u visokome sjaju: bijela, crna

Door and body:

- foiled fibreboard (MDF) with high-gloss finish: white, black

Front und Korpus:

- Faserplatte (MDF) Hochglanz foliert: Weiß, Schwarz

Steklena vitrina / Staklena vitrina / Glass cabinet / Glasvitrine

Obod: vlaknena plošča (MDF) lakirana z visokosijajnim ali mat lakom: bela sijaj, črna sijaj, čokoladno rjava mat

Obod: vlaknatca (MDF), lakirana visokosijajnim ili mat lakom: bijela sjaj, crna sjaj, čokoladno smeđa mat

Body: fibreboard (MDF) coated with high-gloss or satin lacquer: white gloss, black gloss, chocolate brown matt

Korpus: Faserplatte (MDF), lackiert mit Hochglanzlack oder Mattlack: Weiß Hochglanz, Schwarz Hochglanz, Schokoladenbraun Matt

VSESTRANSKE KOPALNIŠKE OMARICE - SVESTRANI ORMA- RIČI ZA KUPAONICE - ALL-PURPOSE BATHROOM CABINETS - UNIVERSELLE BADEZIMMERSCHRÄNKE

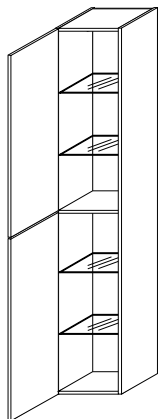

E 30.05 L,D
Omara »svinčnik« L,D
Ormar »olovka« L,D
»Pencil« cabinet L,R
Schrank »Bleistift« L,R
• 30/180/35
257,02 PT *

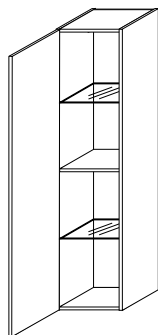

D 30.05 L,D
Omara »svinčnik« L,D
Ormar »olovka« L,D
»Pencil« cabinet L,R
Schrank »Bleistift« L,R
• 30/130/35
235,10 PT *

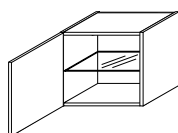

B 45.10 L,D
Kocka L,D
Kocka L,D
Cube L,R
Würfel L,R
• 45/45/18
108,74 PT *

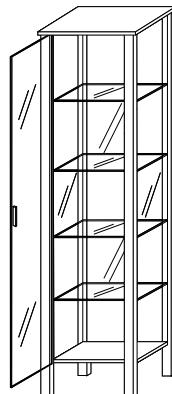

E 45.02 L,D
Steklena vitrina L,D
Staklena vitrina L,D
Glass cabinet L,R
Glasvitrine L,R
• 46,6/181,8/46
415,76 PT *

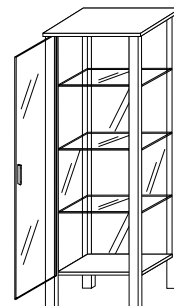

D 45.02 L,D
Steklena vitrina L,D
Staklena vitrina L,D
Glass cabinet L,R
Glasvitrine L,R
• 46,6/131,8/46
318,76 PT *



Steklena vitrina, kocka in omara "svinčnik" so kopalniške omarice enostavnih linij in nevtralnih barv. Lahko nastopajo kot samostojni elementi v različnih kreativnih postavitvah ali pa so učinkovita kombinacija k linijam, kot so: Kuba, Markiz, Julija, Avon, Monet...



Steklena vitrina, kocka i ormar »olovka« jesu ormariči za kupaonice jednostavnih linija i nevtralnih boja. Mogu nastupati kao samostalni elementi u različitim kreativnim postavljanjima ili kao učinkovita kombinacija s linijama poput ovih: Kuba, Markiz, Julija, Avon, Monet...

Omara »svinčnik« / Ormar »olovka« / »Pencil« cabinet / Schrank »Bleistift«

Vrata in obod:

- oplaščena vlaknena plošča (MDF) v visokem sijaju: bela, črna

Vrata i obod:

- obložena vlaknatca (MDF) u visokome sjaju: bijela, crna

Door and body:

- foiled fibreboard (MDF) with high-gloss finish: white, black

Front und Korpus:

- Faserplatte (MDF) Hochglanz foliert: Weiß, Schwarz

Kocka / Kocka / Cube / Würfel

Vrata in obod:

- oplaščena vlaknena plošča (MDF) v visokem sijaju: bela, črna

Vrata i obod:

- obložena vlaknatca (MDF) u visokome sjaju: bijela, crna

Door and body:

- foiled fibreboard (MDF) with high-gloss finish: white, black

Front und Korpus:

- Faserplatte (MDF) Hochglanz foliert: Weiß, Schwarz

Steklena vitrina / Staklena vitrina / Glass cabinet / Glasvitrine

Obod: vlaknena plošča (MDF) lakirana z visokosijajnim ali mat lakom: bela sijaj, črna sijaj, čokoladno rjava mat

Obod: vlaknatca (MDF), lakirana visokosijajnim ili mat lakom: bijela sjaj, crna sjaj, čokoladno smeđa mat

Body: fibreboard (MDF) coated with high-gloss or satin lacquer: white gloss, black gloss, chocolate brown matt

Korpus: Faserplatte (MDF), lackiert mit Hochglanzlack oder Mattlack: Weiß Hochglanz, Schwarz Hochglanz, Schokoladenbraun Matt



Glass cabinet, cube and »pencil« cabinet are bathroom cabinets of simple lines and neutral colours. They can be used individually in various creative compositions or to complement efficiently the lines such as Kuba, Markiz, Julija, Avon, Monet...

Glasvitrine, Würfel und Schrank »Bleistift« sind Badezimmer-schränke mit klaren Linien und in Neutralfarben. Sie können wie alleinstehende Elemente in verschiedener kreativer Aufstellung oder als wirkungsvolle Kombination zu den Linien, wie Kuba, Markiz, Julija, Avon, Monet... vorkommen.

S T A N D A R D



Lepota, ki prisega na večnost, ustvarja občutek domačnosti in prijetne topline.

Ljepota koja premašuje vječnost, ostvaruje osjećaj domaće atmosfere i ugodne topline.

B E A U T Y



Iris 68



Perla 70



Gea 72



Jana 73

The beauty relying on eternity creates a sense of homeliness and pleasant warmth.

Die ewige Schönheit bietet das Gefühl der Geborgenheit und angenehme Wärme.

IRIS





◀ **Kopalniško pohištvo:**

- Vrata: IRIS bordo rdeča visok sijaj
- Obod: bel
- Ročaj: 104.Cr

Barva sanitarne opreme:

- DOLOPOL BISER

Namještaj za kupaonice:

- Vrata: IRIS bordo crvena visoki sjaj
- Obod: bijeli
- Ročaj: 104.Cr

Boja sanitarne opreme:

- DOLOPOL BISER

Bathroom cabinets:

- Door: IRIS bordeaux red high gloss
- Body: white
- Handle: 104.Cr

Sanitary ware colour:

- DOLOPOL BISER

Badezimmermöbel:

- Front: IRIS Bordeaux rot Hochglanz
- Korpus: Weiß
- Griff: 104.Cr

Farbe der Sanitäreinrichtung:

- DOLOPOL BISER

PERLA





◀ **Kopalniško pohištvo:**

- Vrata: PERLA bela
- Obod: bel
- Ročaj: 72.Cr

Barva sanitarne opreme:

- DOLOPOL BISER

Namještaj za kupaonice:

- Vrata: PERLA bijela
- Obod: bijeli
- Ručka: 72.Cr

Boja sanitarne opreme:

- DOLOPOL BISER

Bathroom cabinets:

- Door: PERLA white
- Body: white
- Knob: 72.Cr

Sanitary ware colour:

- DOLOPOL BISER

Badezimmermöbel:

- Front: PERLA Weiß
- Korpus: Weiß
- Griff: 72.Cr

Farbe der Sanitäreinrichtung:

- DOLOPOL BISER

GEA



▲
Kopalniško pohištvo:

- Vrata: GEA bela
- Obod: bel
- Ročaj: 58.Zn/sijaj

Barva sanitarne opreme:

- DOLOPOL BISER

Namještaj za kupaonice:

- Vrata: GEA bijela
- Obod: bijeli
- Ručka: 58.Zn/sjaj

Boja sanitarne opreme:

- DOLOPOL BISER

Bathroom cabinets:

- Door: GEA white
- Body: white
- Handle: 58.Zn/gloss

Sanitary ware colour:

- DOLOPOL BISER

Badezimmermöbel:

- Front: GEA weiß
- Korpus: weiß
- Griff: 58.Zn/Glanz

Farbe der Sanitäreinrichtung:

- DOLOPOL BISER

JANA



Kopalniško pohištvo:

- Vrata: JANA bela
- Obod: bel
- Ročaj: 92.Cr

Barva sanitarne opreme:

- DOLOPOL BISER

Namještaj za kupaonice:

- Vrata: JANA bijela
- Obod: bijeli
- Ručka: 92.Cr

Boja sanitarne opreme:

- DOLOPOL BISER

Bathroom cabinets:

- Doors: JANA white
- Body: white
- Handle: 92.Cr

Sanitary ware colour:

- DOLOPOL BISER

Badezimmermöbel:

- Front: JANA Weiß
- Korpus: Weiß
- Griff: 92.Cr

Farbe der Sanitäreinrichtung:

- DOLOPOL BISER

Umivalnik po meri TRENDLINE / Umivaonik po mjeri TRENDLINE Custom-made basin TRENDLINE / Waschbecken nach Maß TRENDLINE



Običajni umivalniki so premajhni ali preveliki. Nič več! Umivalnik Trendline ima razsežnosti, kakršne si zaželite vi. Najmanj 70 in največ 200 centimetrov ter prav vse mere vmes lahko znaša dolžina vašega Trendline umivalnika. Vi določite, kakšna je dolžina, ki vam in vaši kopalnici resnično ustreza.

Uobičajeni umivaonici jesu premali ili preveliki. Ne više! Umivaonik Trendline ima dimenzije kakve god zaželite. Dužina vašeg Trendline umivaonika može iznositi najmanje 70 i najviše 200 centimetara te može imati baš sve među mjere. Vi odredite koja dužina stvarno odgovara vama i vašoj kupaonici.

Typically, basins are either too small or too large. Not any more! With Trendline, you can specify exactly how big your basin will be – anywhere from a minimum of 70 cm to a maximum of 200 cm including all sizes in between. You get to determine the size that is right for you and your bathroom.

Die üblichen Waschbecken sind entweder zu klein oder zu groß. Nicht mehr! Dimensionen des Waschbeckens Trendline entsprechen Ihren Wünschen. Alle Dimensionen zwischen Minimum 70 und Maximum 200 cm stehen für Ihren Trendline Waschbecken zu Verfügung. Sie bestimmen den Maß, der Ihnen und Ihrem Badezimmer tatsächlich entspricht.

Primer vgradnje umivalnika po meri in ustreznih omarič

Primjer ugradnje umivaonika po mjeri i odgovarajućih ormarića

Example of a custom-made basin and matching cabinets

Beispiel des Einbaus des Waschbeckens nach Maß und der entsprechenden Schränke

Širina elementa po naročilu
Širina elementa po narudžbi
Width of the custom-made unit
Breite des Elements nach Bestellung
• F 18 x 90 x 19

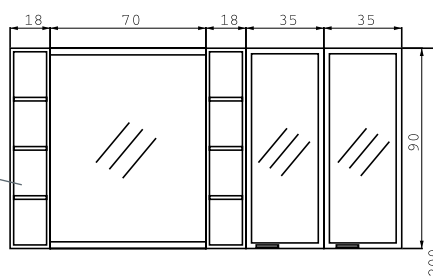

Širina elementa po naročilu
Širina elementa po narudžbi
Width of the custom-made unit
Breite des Elementes nach Bestellung
• F 18 x 60 x 33

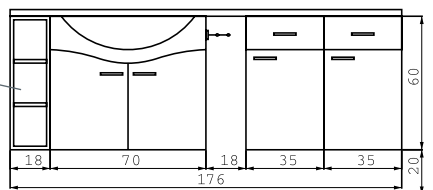

Ostali elementi su standardnih dimenzija
Ostali elementi su standardnih dimenzija
Other units are standard size.
Die anderen Elemente sind in Standarddimensionen

Pri naročilu umivalnika navedite mere A, B in L.
Kod narudžbe umivaonika navedite mjere A, B i L
When placing your order, please state dimensions A, B and L.
Bei der Bestellung des Waschbeckens geben Sie die Dimensionen A, B und L an.

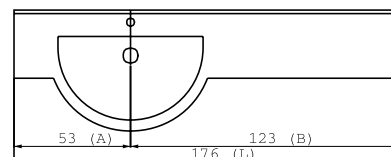

Program vrat kopalniškega pohištva Standard / Program vrata namještaja za kupaonice Standard
 Bathroom cabinet doors Standard / Frontvarianten Standard

**IRIS**

bela visok sijaj / bijela visoki sjaj
 white high gloss / Weiß Hochglanz

**IRIS**

vanilija visok sijaj / vanilija visoki sjaj
 vanilla high gloss / Vanille Hochglanz

**IRIS**

bordo rdeča visok sijaj / bordo
 crvena visoki sjaj / bordeaux red
 high gloss / Bordeaux rot Hochglanz

**JANA**

bela visok sijaj / bijela visoki sjaj
 white high gloss / Weiß Hochglanz

**GEA**

bela visok sijaj / bijela visoki sjaj
 white high gloss / Weiß Hochglanz

**PERLA**

bela visok sijaj / bijela visoki sjaj
 white high gloss / Weiß Hochglanz

Vrata:

- oplasčena vlaknena plošča (MDF) v visokem sijaju

Obod:

- oplemenitena iverna plošča: bela sijaj

Vrata:

- obložena vlaknatica (MDF) u visokome sjaju

Obod:

- oplemenjena iverica: bijela sjaj

Door:

- foiled fibreboard (MDF) with high-gloss finish

Body:

- laminated particle board: white gloss

Front:

- Faserplatte (MDF) Hochglanz foliert

Korpus:

- Kunststoffoberfläche: Weiß Glanz

Ročaji / Ručke / Knobs and Handles / Griffe

		IRIS	JANA	GEA	PERLA
104.Cr 32 mm*		Grey	Grey	Grey	Red
92.Cr 96 mm*		Grey	Grey	Grey	Red
70.Cr/mat 128 mm*		Grey	Grey	Grey	Red
36.Cr 96 mm*		Grey	Grey	Grey	Red
65.Ni 96 mm*		Grey	Grey	Grey	Red
84.Cr/mat 96 mm*		Grey	Grey	Grey	Red
80.Cr 64 mm*		Grey	Grey	Grey	Red
58.Zn/sij 64 mm*		Grey	Grey	Grey	Red
29.Cr 64 mm*		Grey	Grey	Grey	Red
72.Cr		Grey	Grey	Grey	Red

ne priporočamo / ne preporučujemo
 not recommended / nicht empfohlen

možnost izbire - upoštevati je potrebno navodilo za vrtanje / mogućnost izbora - treba uvažavati upute za bušenje
 optional - drilling instructions should be followed / andere Stelle - das Bohren nach den Anweisungen

priporočeni glede na nakazane izvrtine v vratih / preporučene s obzirom na označene provrte u vratima
 recommended in line with indicated drill hole positions in the doors / empfohlen die markierten Bohrlöcher an den Türen

* Razmak med izvrtinama
 * Razmak između provrta
 * Spacing between drill holes
 * Abstand zwischen den Bohrlöchern

Program elementov / Program elemenata / Bathroom furniture / Typenübersicht

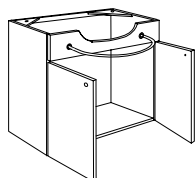

F 70.163
 Element pod umivalnikom z nosilcem za brisače
 Element ispod umivaonika s nosačem ručnika
 Vanity cabinet with towel rail
 Waschbeckenunterschrank mit Handtuchhalter
 • 70/60/35
 141,26 PT *

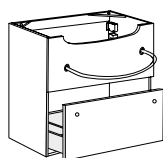

F 70.161
 Element pod umivalnikom s predalom in nosilcem za brisače
 Element ispod umivaonika s ladicom i nosačem ručnika
 Vanity cabinet with drawer and towel rail
 Waschbeckenunterschrank mit Schublade und Handtuchhalter
 • 70/60/35
 195,81 PT *

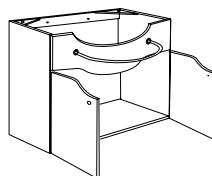

F 70.120 (UM TRENDLINE)
 Element pod umivalnikom z nosilcem za brisače
 Element ispod umivaonika s nosačem ručnika
 Vanity cabinet with towel rail
 Waschbeckenunterschrank mit Handtuchhalter
 • 70/60/35
 144,54 PT *

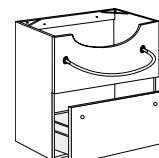

F 70.167 (UM TRENDLINE)
 Element pod umivalnikom s predalom in nosilcem za brisače
 Element ispod umivaonika s ladicom i nosačem ručnika
 Vanity cabinet with drawer and towel rail
 Waschbeckenunterschrank mit Schublade und Handtuchhalter
 • 70/60/35
 195,73 PT *

Program elementov / Program elemenata / Bathroom furniture / Typenübersicht

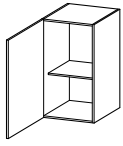

B 35.110 L,D
Element L,D
Element L,D
Cabinet L,R
Element L,R
• 35/60/35
72,85 PT *

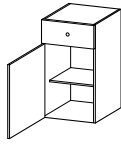

B 35.132 L,D
Element s predaloma L,D
Element s ladicom L,D
Cabinet with drawer L,R
Element mit Schublade L,R
• 35/60/35
126,45 PT *

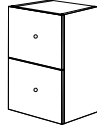

B 35.147
Element s predaloma
Element s dvije ladice
Drawer unit, two drawers
Element mit zwei Schubladen
• 35/60/35
185,16 PT *

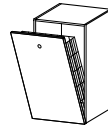

B 35.193
Element s košarom
Element s košarom
Laundry basket unit
Element mit Korb
• 35/60/35
102,50 PT *

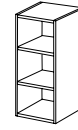

F Bx60x33
Element s policama 15-35 cm
Element s policama 15 - 35 cm
Shelf unit 15-35 cm
Element mit Ablagen 15-35 cm
• min 15-max 35/60/33
31,24 - 44,26 PT *

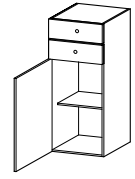

C 35.142 L,D
Element z dvema predaloma L,D
Element s dvije ladice L,D
Cabinet with two drawers L,R
Element mit zwei Schubladen L,R
• 35/90/35
200,88 PT *

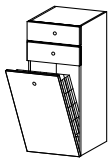

C 35.193
Element z dvema predaloma in košarom
Element s dvije ladice i košarom
Cabinet with two drawers and laundry basket
Element mit zwei Schubladen und mit dem Korb
• 35/90/35
230,53 PT *

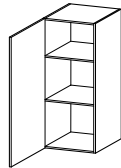

C 35.107 L,D
Element L,D
Element L,D
Cabinet L,R
Element L,R
• 35/90/35
97,75 PT *

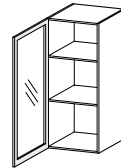

C 35.112 ZG/C 35.112 SP
Zgornji in spodnji element s steklenimi vrati - L,D
Gornji i donji element sa staklenim vratima L,D
Glass door cabinet, wall- mounted or floor-mounted L,R
Wand- und Unterschrank mit Glasfront L,R
• 35/90/35
147,99 PT *



F Bx90x33
Element s policama 15-35 cm
Element s policama 15-35 cm
Shelf unit 15-35 cm
Element mit Ablagen 15-35 cm
• mini15-max 35/90/33
31,24 - 44,26 PT *

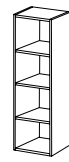

F Bx90x19
Element s policama 15-35 cm
Element s policama 15-35 cm
Shelf unit 15-35 cm
Element mit Ablagen 15-35 cm
• mini15-max 35/90/19
31,24 - 44,26 PT *

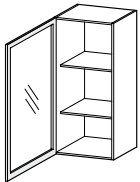

C 35.19 ZG/C 35.19 SP
Zgornji in spodnji element s steklenimi vrati L,D
Gornji i donji element sa staklenim vratima L,D
Glass door cabinet, wall-mounted or floor-mounted L,R
Wand- und Unterschrank mit Glasfront L,R
• 35/90/20
126,73 PT *

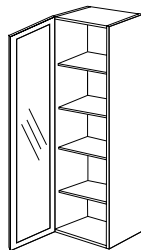

D 35.112 AI (L,D)
Element s steklenimi vrati L,D
Element sa staklenim vratima L,D
Glass door cabinet L,R
Element mit Glasfront L,R
• 35/120/35
171,74 PT *

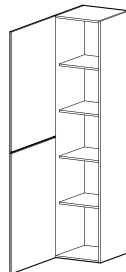

E 35.162 L,D
Omara L,D
Omar L,D
Tall cabinet L,R
Hochschrank L,R
• 35/180/35
164,81 PT *

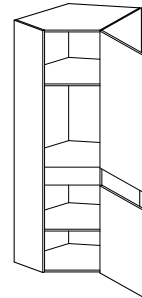

E 56.161 D,L
Kotna omara D,L
Kutni ormar D,L
Corner unit R,L
Eckschrank R,L
• 56x56/180/35
254,37 PT *

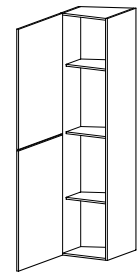

E 17.108 L,D
Zaključni element L,D
Završni element L,D
End unit L,R
Schlusselement L,R
• 17,5/180/35(25)
136,35 PT *

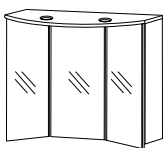

F 105.50
Element z ogledali in svetili
Element s ogledalima i svjetlima
Mirror cabinet with lights
Spiegelschrank mit Leuchten
• 105/90/23(19)
259,20 PT *

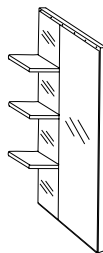

F 70.31 L,D
Element z ogledali in policama L,D
Element s ogledalima i policama L,D
Shelf unit with mirrors L,R
Spiegelpaneel mit Ablagen L,R
• 70/116,3/19
78,39 PT *

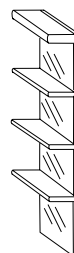

F 35.35
Element z ogledali in policami
Element s ogledalima i policama
Shelf unit with mirrors
Spiegelpaneel mit Ablagen
• 35/116,3/19
70,63 PT *



F 35.97
Element z ogledali in policami
Element s ogledalima i policama
Shelf unit with mirrors
Spiegelpaneel mit Ablagen
• 35/87/19
57,56 PT *

Program elementov / Program elemenata / Bathroom furniture / Typenübersicht

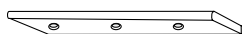

F 105.12
 Polica s svetili, stikalom in vtičnico
 Polica sa svjetlima, prekidačem i utičnicom
Shelf with lights, switch and power outlet
 Ablage mit Leuchten, Schalter und Stecker
 • 105/2,8/19
95,89 PT *

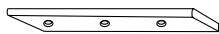

F 90.12
 Polica s svetili, stikalom in vtičnico
 Polica sa svjetlima, prekidačem i utičnicom
Shelf with lights, switch and power outlet
 Ablage mit Leuchten, Schalter und Stecker
 • 90/2,8/19
96,01 PT *



F 70.12
 Polica s svetili, stikalom in vtičnico
 Polica sa svjetlima, prekidačem i utičnicom
Shelf with lights, switch and power outlet
 Ablage mit Leuchten, Schalter und Stecker
 • 70/2,8/19
83,50 PT *

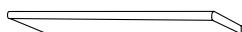

PL 105.12
 Polica pod ogledalom
 Polica ispod ogledala
Mirror shelf
 Ablage unter dem Spiegel
 • 105/2,8/19
29,38 PT *



PL 90.12
 Polica pod ogledalom
 Polica ispod ogledala
Mirror shelf
 Ablage unter dem Spiegel
 • 90/2,8/19
27,20 PT *

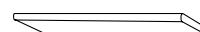

PL 70.12
 Polica pod ogledalom
 Polica ispod ogledala
Mirror shelf
 Ablage unter dem Spiegel
 • 70/2,8/19
23,79 PT *



Segment ogledala
 Segment ogledala
Mirror panel
 Spiegelsegment
 • 35/26,3/2
10,10 PT *

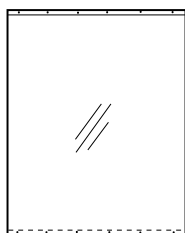

Ogledalo / Ogledalo
 Mirror / Spiegel
 • 70/90/2 **40,07 PT ***
 • 70/116,3/2 **40,78 PT ***
 • 90/90/2 **53,26 PT ***
 • 90/116,3/2 **66,01 PT ***
 • 105/90/2 **60,92 PT ***
 • 105/116,3/2 **75,52 PT ***

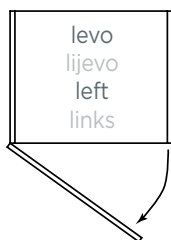

Koordinacijske mere / Koordinacijske mjere / Coordination sizes / Koordinationsdimensionen

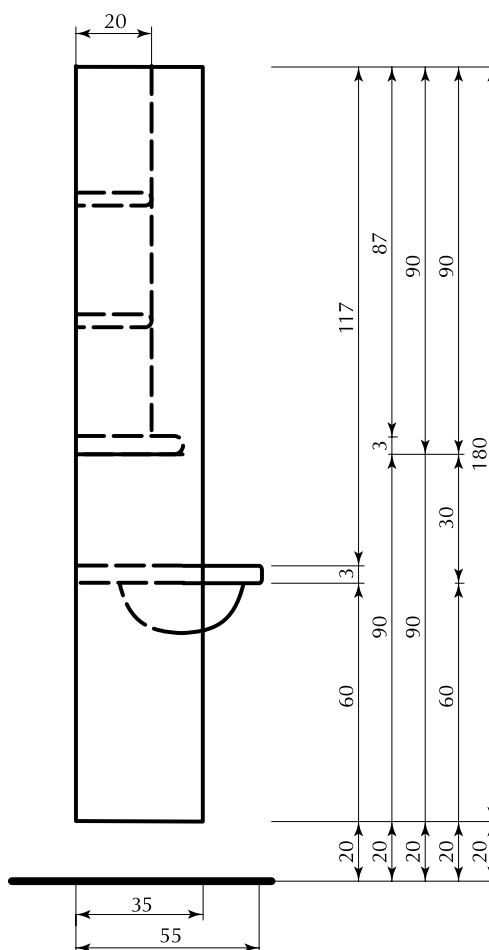

Umivalniki in pripadajoči podumivalni elementi / Umivaonici i pripadajući elementi ispod umivaonika / Basins and matching vanity cabinets / Waschbecken und zugehörige Unterschränke

Umivalniki Standard - Umivaonici Standard - Basins Standard - Waschbecken Standard



UM 70.140
104,64 PT *

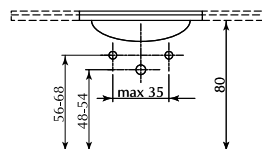
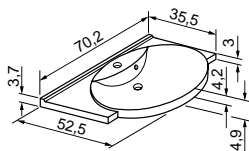

UM 105.140 L
117,48 PT *

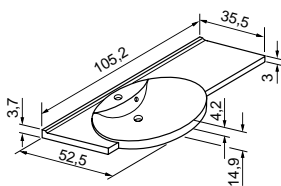

UM 105.140 D
117,48 PT *

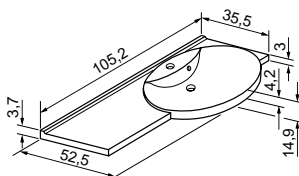

UM 140.140
136,27 PT *

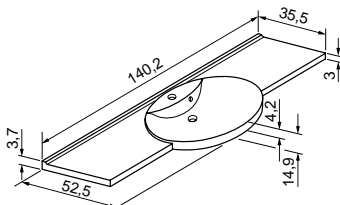

UM 140.141
162,87 PT *

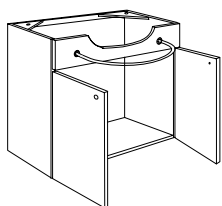
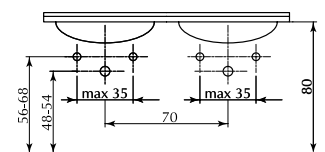
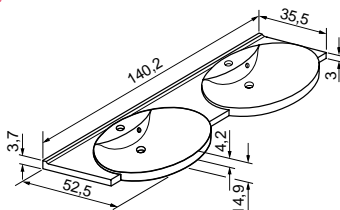

F 70.163
Element pod umivalnikom z nosilcem za brisače
Element ispod umivaonika s nosačem ručnika
Vanity cabinet with towel rail
Waschbeckenunterschrank mit Handtuchhalter
• 70/60/35
141,26 PT *

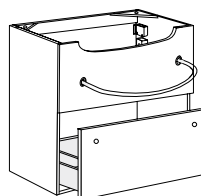

F 70.161
Element pod umivalnikom s predalom in nosilcem za brisače
Element ispod umivaonika s ladicom i nosačem ručnika
Vanity cabinet with drawer and towel rail
Waschbeckenunterschrank mit Schublade und Handtuchhalter
• 70/60/35
195,81 PT *

Umivalniki in pripadajoči podumivalni elementi / Umivaonici i pripadajući elementi ispod umivaonika / Basins and matching vanity cabinets / Waschbecken und zugehörige Unterschränke

Umivalniki Trendline - Umivaonici Trendline - Trendline basins - Waschbecken Trendline

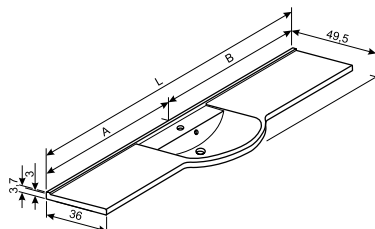

- UM 79.142 od 70 - 79 cm 238,32 PT *
- UM 99.142 od 80 - 99 cm 250,93 PT *
- UM 119.142 od 100 - 119 cm 259,04 PT *
- UM 139.142 od 120 - 139 cm 268,29 PT *
- UM 159.142 od 140 - 159 cm 283,38 PT *
- UM 179.142 od 160 - 179 cm 293,04 PT *
- UM 200.142 od 180 - 200 cm 301,59 PT *

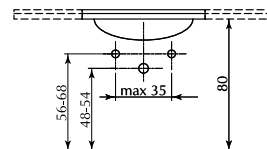

UM TRENDLINE

Umivalnik po meri (maks. dolžina 200 cm, min. dolžina 70 cm). Ob naročilu navedite mere L, A in B.

Umivaonik po mjeri (maks. dužina 200 cm, min dužina 70 cm) Pri narudžbi navedite mjere L, A i B.

Custom-made basin (max. length 200 cm, min. length 70 cm) When placing your order, please state dimensions L, A and B.

Waschbecken nach Maß (Maximumlänge 200 cm, Minimumlänge 70 cm) Bei Bestellung geben Sie die Dimensionen L, A und B an.

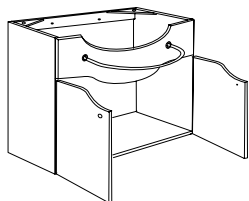

F 70.120 (UM TRENDLINE)

Element pod umivalnikom z nosilcem za brisače / Element ispod umivaonika s nosačem ručnika / Vanity cabinet with towel rail / Waschbeckenunterschrank mit Handtuchhalter

- 70/60/35
- 144,54 PT *

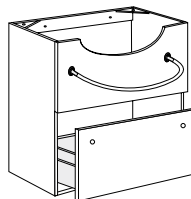

F 70.167 (UM TRENDLINE)

Element pod umivalnikom s predalom in nosilcem za brisače

Element ispod umivaonika s ladicom i nosačem ručnika

Vanity cabinet with drawer and towel rail / Waschbeckenunterschrank mit Schublade und Handtuchhalter

- 70/60/35
- 195,73 PT *

Odlagalne police / Police za odlaganje / Top shelves / Ablagen



PO 70.19

Odlagalna polica iz kompozitnega materiala

Polica za odlaganje od kompozitnoga materijala

Top shelf made of composite material

Ablage aus Kompositmaterial

- 54,58 PT *

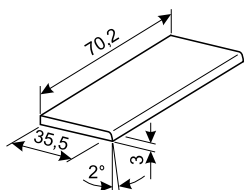

PO 35.19

Odlagalna polica iz kompozitnega materiala

Polica za odlaganje od kompozitnoga materijala

Top shelf made of composite material

Ablage aus Kompositmaterial

- 37,26 PT *

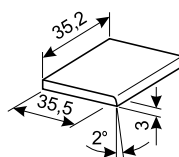

WC školjke in bideji / WC-školjke i bidei / WC pans and bidets / Toiletschüssel und Bidet

WC deska v kompletu / WC daska u kompletu
Toilet set included / WC Brett im Komplett

WC 39.28
WC školjka Kuba
WC školjka Kuba
Toilete bowl Kuba
Toiletenschüssel Kuba
639,41 PT *

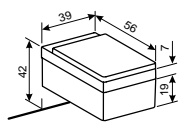

WC 39.28

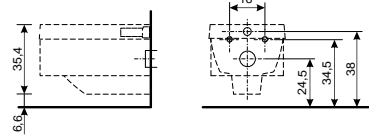

WC 39.28



BD 39.28
Bide Kuba
Bide Kuba
Bidet Kuba
Bidet Kuba
407,57 PT *

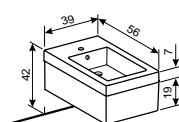

BD 39.28

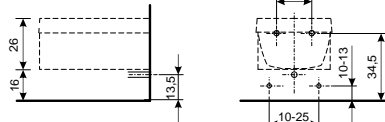

BD 39.28



WC 39.27
WC školjka Julija
WC školjka Julija
Toilete bowl Julija
Toiletenschüssel Julija
531,76 PT *

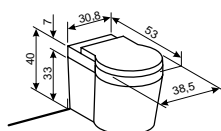

WC 39.27

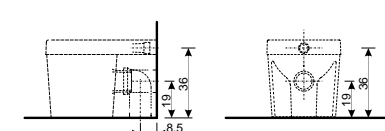

WC 39.27



BD 39.27
Bide Julija
Bide Julija
Bidet Julija
Bidet Julija
337,92 PT *

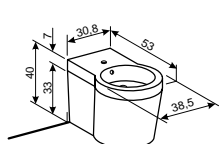

BD 39.27

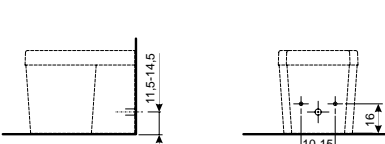

BD 39.27



WC 39.26
425,80 PT *

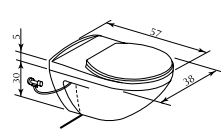

WC 39.26

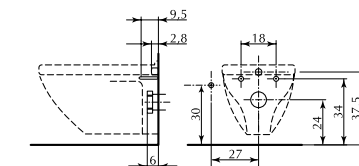

WC 39.26

WC 39.26 - s šobo za izpiranje
WC 39.26 - sa mlaznicom za ispiranje
WC 39.26 - flush toilet with trigger nozzle
WC 39.26 - mit Spüldüse



WC 39.23
405,08 PT *

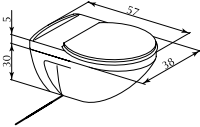

WC 39.23

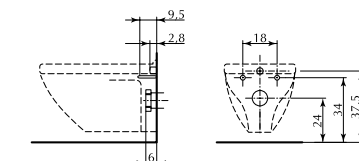

WC 39.23



BD 39.23
251,82 PT *

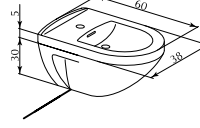

BD 39.23

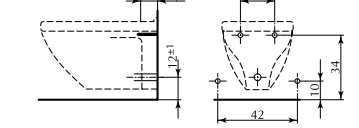

BD 39.23

Tuš kadi in kabine / Tuš-kade i kabine / Shower trays and cabins / Duschwannen und -kabinen

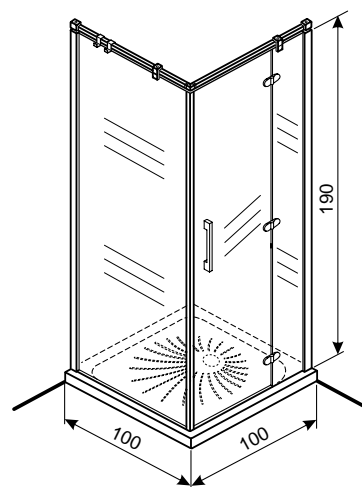
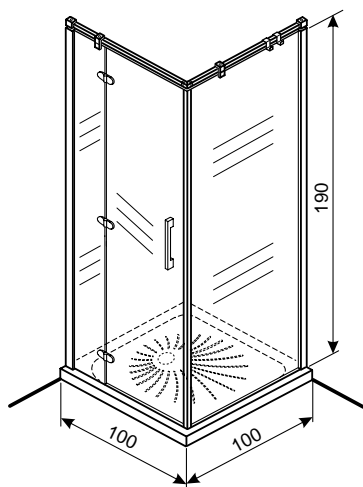

KTK 100.37

Kaljeno prozorno steklo z Antiplaque premazom
 Kaljeno prozirno staklo s premazom Antiplaque
 Tempered transparent glass with Antiplaque coating
 Gehärtetes Klarglas mit Antiplaque Beschichtung
865,37 PT *

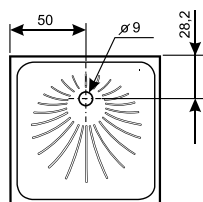
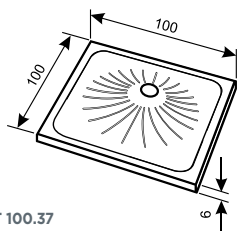

KT 100.37
214,93 PT *

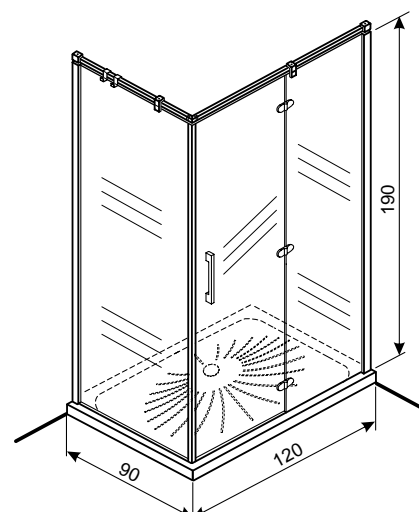
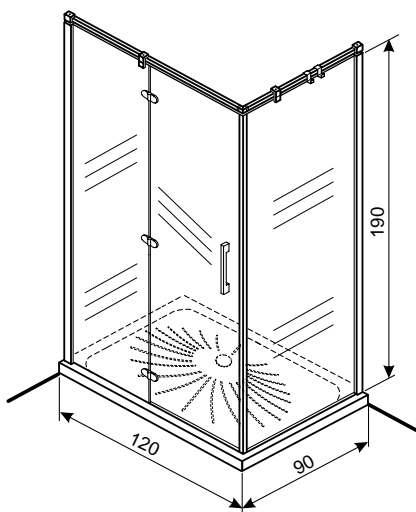

KTK 120.40

Kaljeno prozorno steklo z Antiplaque premazom
 Kaljeno prozirno staklo s premazom Antiplaque
 Tempered transparent glass with Antiplaque coating
 Gehärtetes Klarglas mit Antiplaque Beschichtung
886,78 PT *

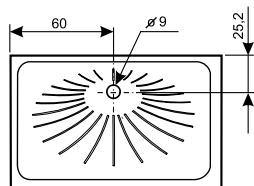
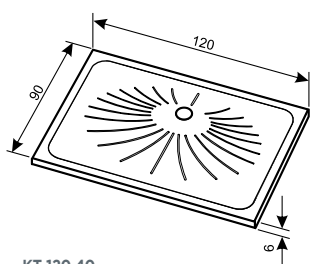

KT 120.40
218,86 PT *

Tuš kadi in kabine / Tuš-kade i kabine / Shower trays and cabins / Duschwannen und -kabinen

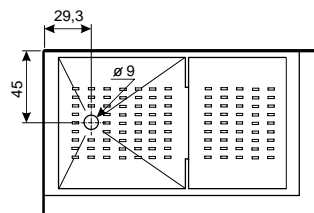
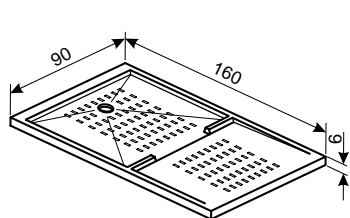
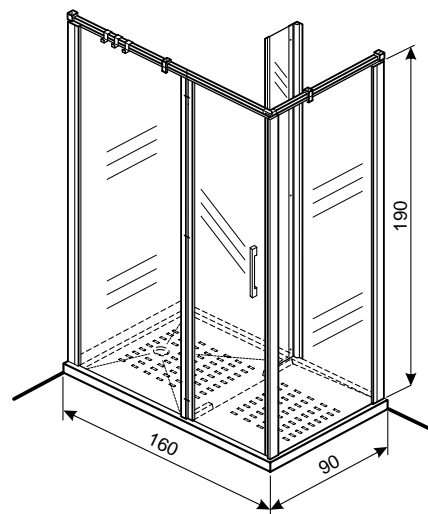
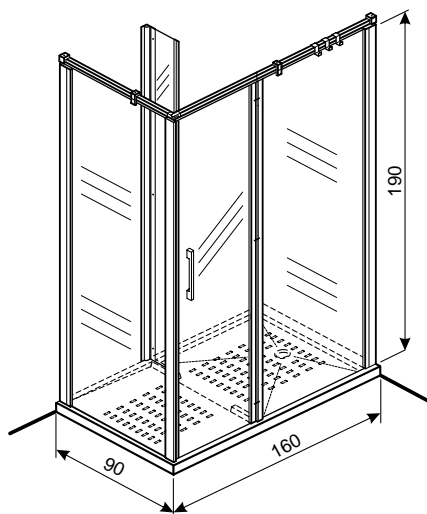

KT 160.75
Tuš kad Kuba
288,88 PT *

KTK 160.75

Tuš kabina Kuba

Kaljeno prozorno steklo z Antiplaque premazom

Kaljeno prozirno staklo s premazom Antiplaque

Tempered transparent glass with Antiplaque coating

Gehärtetes Klarglas mit Antiplaque Beschichtung

1.300,78 PT *

Tuš kad in kabina Kuba / Tuš-kada i kabina Kuba Shower tray and cabin Kuba / Duschwanne und -kabinen Kuba

Izpod prhe stopimo suhi v odprt prostor ...
Zakaj pa ne tudi v spalnico?
To nam omogoča inovativna rešitev vrtljivih vrat tuš kabine.

Od tuša stupamo suhi u prostor...
Zašto ne bismo i u spavaću sobu?
To omogućuje inovativno rješenje rotacijskih
vrata tuš-kabine.

We exit the shower, already dry and enter the
room... Why not the bedroom as well? This is
made possible by an innovative solution of the
shower cabin's revolving door.

Aus der Dusche treten wir in einen trockenen
Raum... Warum nicht auch in das Schlafzimmer?
Das ermöglicht uns die innovative Lösung mit
Drehtüren der Duschkabine.

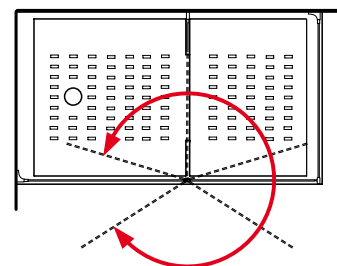

Antiplaque zaščitni premaz / Zaštitni premaz antiplaque Antiplaque protective coating / Antiplaque Schutzbeschichtung



Antiplaque premaz je zaščitni premaz, ki poskrbi, da vodne kapljice hitreje zdrsnejo po površini stekla. Preprečuje odlaganje apnenca in nečistoč na steklu.

Zaštitni premaz Antiplaque jest zaštitni premaz koji omogućuje da kapljice vode brže skliznu po površini stakla. Sprječava odlaganje vapnenca i nečistoća na staklu.

Antiplaque coating is a protective coating which makes water drops glide faster on the glass surface, thus preventing limescale and impurities from depositing on glass.

Durch die Antiplaque Schutzbeschichtung wird die Glasoberfläche schneller trocken. Kalk und Schmutz können nicht am Glas abgelagert werden.

Tuš kadi in kabine / Tuš-kade i kabine / Shower trays and cabins / Duschwannen und -kabinen

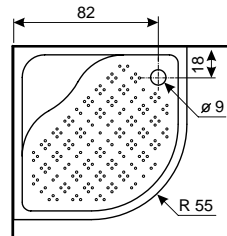
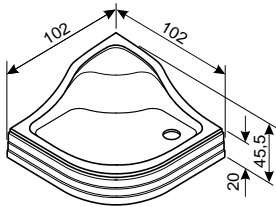
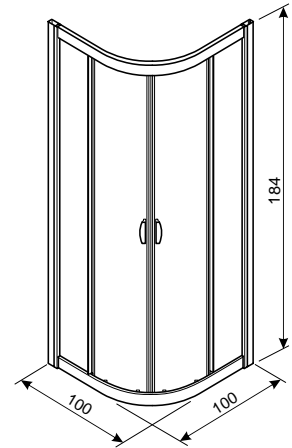

KT 102.65
423,21 PT *

KTK 102.65
Kaljeno mat steklo in bel okvir
Kaljeno mat staklo i bijeli okvir
Tempered opaque glass and white frame
Gehärtetes Mattglas und weiß Korpus
783,10 PT *

KTK 102.66
Kaljeno mat steklo in ALU okvir
Kaljeno mat staklo i ALU okvir
Tempered opaque glass and ALU frame
Gehärtetes Mattglas und ALU Korpus
783,10 PT *

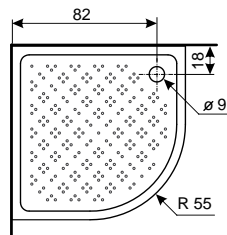
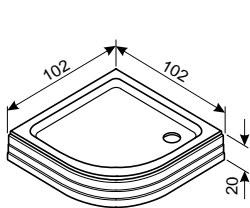
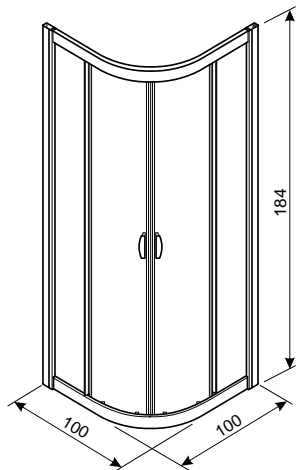

KT 102.70
356,38 PT *

KTK 102.65
Kaljeno mat steklo in bel okvir
Kaljeno mat staklo i bijeli okvir
Tempered opaque glass and white frame
Gehärtetes Mattglas und weiß Korpus
783,10 PT *

KTK 102.66
Kaljeno mat steklo in ALU okvir
Kaljeno mat staklo i ALU okvir
Tempered opaque glass and ALU frame
Gehärtetes Mattglas und ALU Korpus
783,10 PT *

Tuš kadi in kabine / Tuš-kade i kabine / Shower trays and cabins / Duschwannen und -kabinen

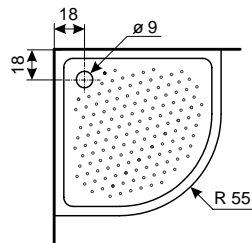
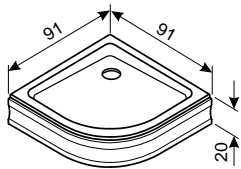
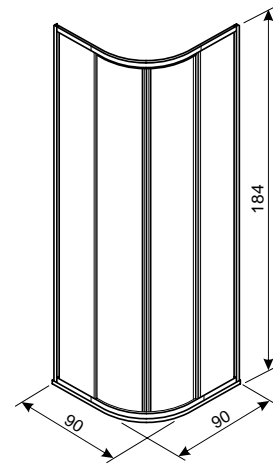

KT 91.60
324,08 PT *

KTK 91.60
Polistiren in bel okvir
Polistiren i bijeli okvir
Polystyrene and white frame
Polistiren und weiß Korpus
280,03 PT *

KTK 91.61
Polistiren in ALU okvir
Polistiren i ALU okvir
Polystyrene and ALU frame
Polistiren und ALU Korpus
280,03 PT *

KTK 91.62
Kaljeno mat staklo in bel okvir
Kaljeno mat staklo i bijeli okvir
Tempered opaque glass and
white frame
Gehärtetes Mattglas und weiß
Korpus
341,30 PT *

KTK 91.63
Kaljeno mat staklo in ALU okvir
Kaljeno mat staklo i ALU okvir
Tempered opaque glass and
ALU frame
Gehärtetes Mattglas und ALU
Korpus
341,30 PT *

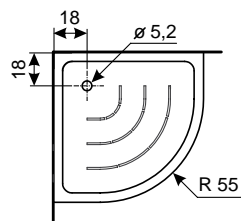
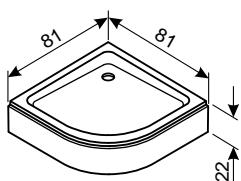
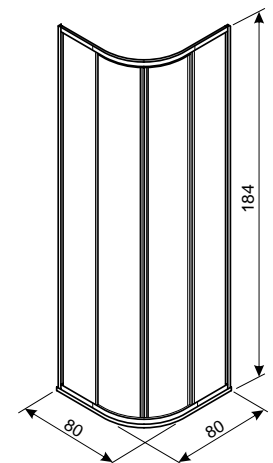

KT 81.55
288,05 PT *

KTK 81.55
Polistiren in bel okvir
Polistiren i bijeli okvir
Polystyrene and white frame
Polistiren und weiß Korpus
211,90 PT *

Masažna tuširna stena / Masažni tuš - panel Massage shower column / Massage - Duschwand



Funkcije sistema:

- 8 malih šob (KROM)
- Mehansko usmerjanje curka
- Masažna tuš ročka z nosilcem

Masažna tuširna stena je na voljo v enakih barvah kot ostala sanitarna oprema. Je samo v kombinaciji s tuš kadjo KT 102.65

Funkcije sistema:

- 8 malih mlaznica (KROM)
- Mehanično usmjeravanje mlaza
- Masažna tuš-ručka s nosačem

Masažna tuširna stijena nudi se u jednakim bojama kao i ostala sanitarna oprema. Samo u kombinaciji s tuš-kadom KT 102.65

System features:

- 8 small nozzles (CHROME)
- Manual control of massage jet direction
- Massage shower set

The massage shower column is available in the same colours as other sanitary ware. It only comes in combination with shower tray KT 102.65

Funktionen des Systems:

- 8 kleine Düsen (KROM)
- Mechanisch gerichteter Wasserstrahl
- Massageduscharm mit dem Träger

Die Duschwand der Massagewanne ist in den gleichen Farben wie die restliche Sanitäreinrichtung verfügbar. Es ist nur die Kombination mit der Duschwanne KT 102.65 möglich

760,39 PT *

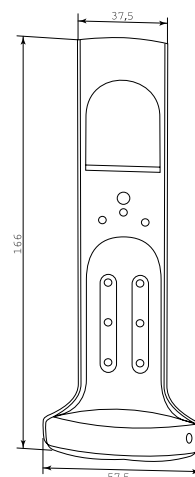

STM 58.21

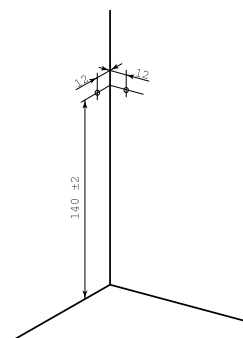

STM 58.21

Masažna tuširna stena DUNA / Masažni tuš - panel DUNA Massage shower column DUNA / Massage - Duschwand DUNA



Funkcije sistema:

- 4 vertikalne šobe
- ročni tuš z nosilcem
- veliki tuš za glavu
- regulator vodnega curka

Funkcije sistema:

- 4 vertikalne mlaznice
- ručni tuš s nosačem
- veliki tuš za glavu
- regulator vodenog mlaza

System features:

- 4 vertical nozzles
- Hand-held shower unit with mount and hose
- Large over head shower unit
- Massage jet control unit

Funktionen des Systems:

- 4 vertikale Düsen
- Handdusche mit dem Träger
- Große Kopfdusche

980,15 PT *

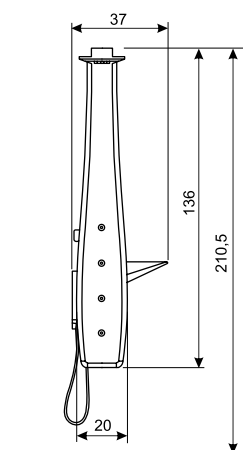
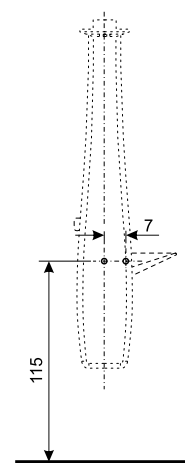

Kopalne kadi in obloge kopalnih kadi / Kade za kupanje i obloge kada za kupanje Bathtubs and bathtub front panels / Badewannen und Badewannenbeläge

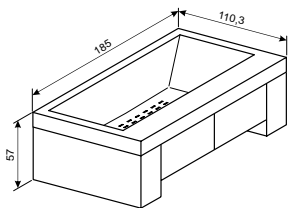

KK 185.28

Kopalna kad Kuba

Barve predalov: bela sijaj, črna sijaj, česana smreka rjava

Kada za kupanje Kuba

Boje ladica: bijela sjaj, crna sjaj, češljana smreka smeda

Bathtub Kuba

Colours of drawers: white gloss, black gloss, spruce brown

Badewanne Kuba

Die Farben der Schubladen: Weiß Glanz, Schwarz Glanz, gekämmte Fichte braun

1.380,20 PT *

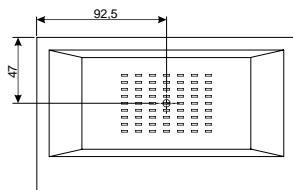

KK 185.28

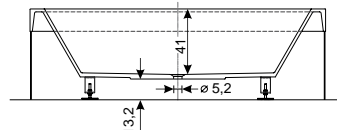

KK 185.28

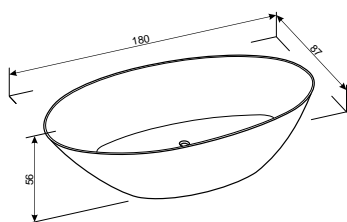

KK 180.36

Kopalna kad Julija (iz materiala Siligor Polar)

Kada za kupanje Julija (od materijala Siligor Polar)

Bathtub Julija (made of Siligor Polar material)

Badewanne Julija (Material Siligor Polar)

1.095,32 PT *

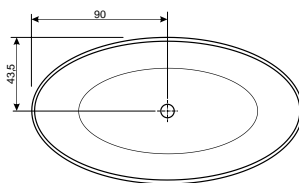

KK 180.36

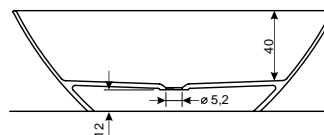

KK 180.36

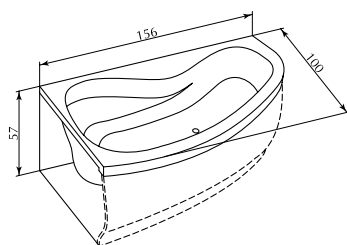

KK 156.04 L, D

Kopalna kad Luna

Kada za kupanje Luna

Bathtub Luna

Badewanne Luna

560,96 PT *

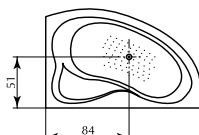

KK 156.04 D

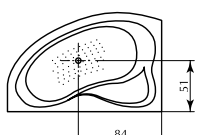

KK 156.04 L

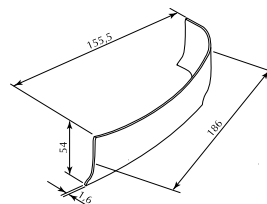

OKK 155.04 L

176,08 PT *

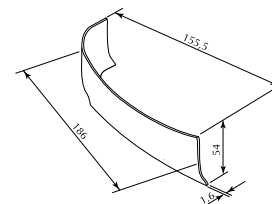

OKK 155.04 D

176,08 PT *



A - Vodni masažni sistem / A - Vodeni masažni sistem
 A - Water massage system / A - Wassermassagesystem

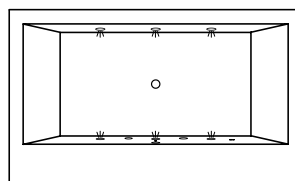

KK 185.30
1.962,33 PT *

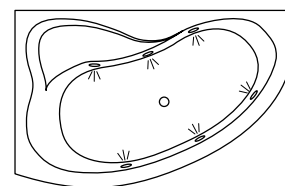

KK 156.09 L, D
1.417,03 PT *

Funkcije sistema:

- 6 standardnih šob (KROM)
- Mehansko usmerjanje curka
- Odpiranje, zapiranje posamezne šobe
- Digitalni vklop
- Senzor nivoja vode

Funkcije sistema:

- 6 standardnih mlaznica (KROM)
- Mehaničko usmjeravanje mlaza
- Otvaranje, zatvaranje pojedinačne mlaznice
- Digitalno uključivanje
- Senzor razine vode

System features:

- 6 standard jet nozzles (CHROME)
- Manual control of massage jet direction
- Opening and closing of individual nozzles
- Digital start
- Water level sensor

Funktionen des Systems:

- 6 Standarddüsen (KROM)
- Mechanisch gerichteter Wasserstrahl
- Öffnen, Schließen der einzelnen Düse
- Digitale Einschaltung
- Sensor des Wasserpegels

B - Vodno zračni masažni sistem / B - Vodeno-zračni masažni sistem
 B - Water-air massage system / B - Wasser-Luftmassagesystem

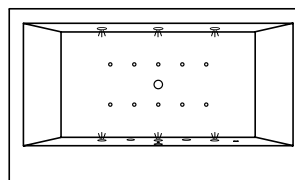

KK 185.32
3.989,71 PT *

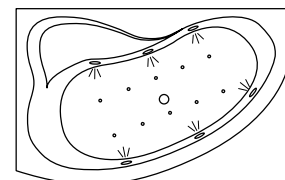

KK 156.07 L, D
3.444,40 PT *

Funkcije sistema:

- 6 standardnih šob (KROM)
- 10 zračnih šob (KROM)
- Mehansko usmerjanje curka
- Odpiranje, zapiranje posamezne šobe
- Digitalni vklop
- Regulacija količine zraka v vodni masaži
- Izpiralno dezinfekcijski sistem Stream Clean. Prihranek na vodi min 150l odvisno od tipa kadi. Potreben dodaten priključek za vodo pod kopalno kadjo.(1/2" - kotni ventil)
- Senzor nivoja vode
- Podvodna lučka

Funkcije sistema:

- 6 standardnih mlaznica (KROM)
- 10 zračnih mlaznica (KROM)
- Mehaničko usmjeravanje mlaza
- Otvaranje, zatvaranje pojedinačne mlaznice
- Digitalno uključivanje
- Regulacija količine zraka kod vodene masaže
- Sistem StreamClean za ispiranje i dezinfekciju. Ušteda vode minimalno 150 l, ovisno od vrste kade. Potreban dodatan priključak za vodu ispod kade za kupanje (1/2" - kutni ventil).
- Senzor razine vode
- Podvodna svjetiljka

System features:

- 6 standard jet nozzles (CHROME)
- 10 air nozzles (CHROME)
- Manual control of massage jet direction
- Opening and closing of individual nozzles
- Digital start
- Adjustable airflow to control jet intensity
- Flush disinfection system StreamClean. A minimum saving of 150 litres of water depending on the type of tub. Requires an extra water inlet to be installed under the tub (1/2" corner valve).
- Water level sensor
- Underwater light

Funktionen des Systems:

- 6 Standarddüsen (KROM)
- 10 Luftdüsen (KROM)
- Mechanisch gerichteter Wasserstrahl
- Öffnen, Schließen der einzelnen Düse
- Digitale Einschaltung
- Regulieren der Luftmenge in Wassermassage
- Desinfektionsdurchspülen StreamClean. Wasserersparnis mindestens 150 l je nach Typ der Badewanne. Ein zusätzlicher Wasseranschluss unter der Badewanne (1/2" - Winkelventil) erforderlich.
- Sensor des Wasserpegels
- Unterwasserleuchte

C - Vodno zračni masažni sistem DELUX / C - Vodeno-zračni masažni sistem DELUX
 C - Water-air massage system DELUX / C - Wasser-Luftmassagesystem DELUX

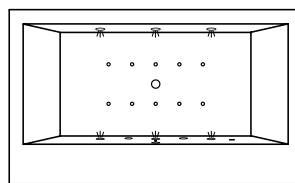

KK 185.34
4.621,63 PT *

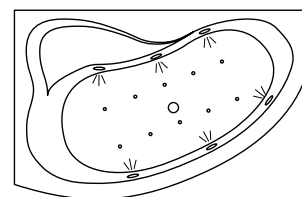

KK 156.11 L, D
4.076,33 PT *

Funkcije sistema:

- 6 standardnih šob (KROM)
- 10 zračnih šob (KROM)
- Mehansko usmerjanje curka
- Odpiranje, zapiranje posamezne šobe
- Digitalni vklop
- Regulacija količine zraka v vodni masaži
- Intervalno delovanje
- Časovna nastavitev
- Izpiralno dezinfekcijski sistem Stream Clean+avtomatsko polnjenje vode. Prihranek na vodi min 150l odvisno od tipa kadi. Potreben dodaten priključek za vodo pod kopalno kadjo. (1/2" - kotni ventil)
- Grelec vode
- Senzor nivoja vode in temper. v kadi
- Podvodna lučka
- Kromoterapija

Funkcije sistema:

- 6 standardnih mlaznica (KROM)
- 10 zračnih mlaznica (KROM)
- Mehanično usmerjanje mlaza
- Otvaranje, zatvaranje pojedinačne mlaznice
- Digitalno uključivanje
- Regulacija količine zraka u vodenoj masaži
- Intervalni rad
- Vremensko podešavanje
- Sistem StreamClean za ispiranje i dezinfekciju+avtomatsko punjenje vode. Ušteda vode minimalno 150 l, ovisno od vrste kade. Potreban dodatan priključak za vodu ispod kade za kupanje (1/2" - kutni venti).
- Grijач vode
- Senzor razine vode i temperature u kadi
- Podvodna svjetiljka
- Kromoterapija

System features:

- 6 standard jet nozzles (CHROME)
- 10 air nozzles (CHROME)
- Manual control of massage jet direction
- Opening and closing of individual nozzles
- Digital start
- Adjustable airflow to control jet intensity
- Interval operation
- Time setting
- Flush disinfection system StreamClean+ automatic filling. A minimum saving of 150 litres of water depending on the type of tub. Requires an extra water inlet to be installed under the tub (1/2" corner valve).
- Water heater
- Water level and temperature sensor
- Underwater light
- Chromotherapy

Funktionen des Systems:

- 6 Standarddüsen (KROM)
- 10 Luftdüsen (KROM)
- Mechanisch gerichteter Wasserstrahl
- Öffnen, Schließen der einzelnen Düse
- Digitale Einschaltung
- Regulieren der Luftmenge in Wassermassage
- Intervallbetrieb
- Zeiteinstellung
- Desinfektionsdurchspülen StreamClean+ selbsttätiger Einlass des Wassers in die Badewanne. Wasserersparnis mindestens 150 l je nach Typ der Badewanne. Ein zusätzlicher Wasseranschluss unter der Badewanne (1/2" - Winkelventil) erforderlich.
- Warmwasserbereiter
- Sensor des Wasserpegels und der Temperatur in der Wanne
- Unterwasserleuchte
- Kromotherapie

Zaslони kopalnih kadi / Zaslони za kade za kupanje / Bathtub screens / Badewanne Spritzwand

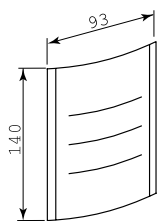
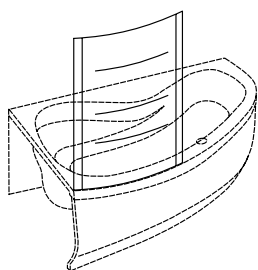

ZKK 93.02 L

Zaslon za kopalno kad KK 156.04 L
 Zaslon za kadu za kupanje KK 156.04 L
 Bathtub screen for KK 156.04 L
 Badewanne Spritzwand KK 156.04 L
 310,40 PT *

ZKK 93.02 L

Zaslon za kopalno kad KK 156.04 L
 Zaslon za kadu za kupanje KK 156.04 L
 Bathtub screen for KK 156.04 L
 Badewanne Spritzwand KK 156.04 L
 310,40 PT *

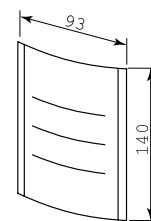
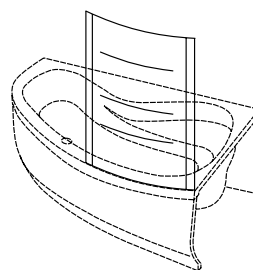

ZKK 93.02 D

Zaslon za kopalno kad KK 156.04 D
 Zaslon za kadu za kupanje KK 156.04 D
 Bathtub screen for KK 156.04 R
 Badewanne Spritzwand KK 156.04 R
 310,40 PT *

ZKK 93.02 D

Zaslon za kopalno kad KK 156.04 D
 Zaslon za kadu za kupanje KK 156.04 D
 Bathtub screen for KK 156.04 R
 Badewanne Spritzwand KK 156.04 R
 310,40 PT *

Program barv sanitarne opreme / Program boja sanitarne opreme Sanitary ware colours / Farben der Sanitäreinrichtung

DOLOPOL



Biser



Silver



Barve po želji / Boje po želji / Colours of your choice / Farben nach Wunsch

GRANIT



Antracit



Barve po želji / Boje po želji / Colours of your choice / Farben nach Wunsch

Sanitarna je oprema proizvedena od kompozitnoga materijala, čija je osnova mljeveni kamen, povezan poliesterskom smolom.

Otpornost

Materijal je otporan na djelovanje uobičajenih kozmetičkih, dezinfekcijskih sredstava te sredstava za čišćenje. Iznimka su kiseline i lužine u koncentracijama većim od 10%. Materijal je neosjetljiv na razne mrlje, elastičan i teško lomljiv. Površina je nepropusna i ugodna na dodir.

Održavanje

Za čišćenje proizvoda od kompozitnoga materijala možete koristiti uobičajena tekuća sredstva za čišćenje. Ne upotrebljavajte sredstva za čišćenje koja sadrže sitno mljeveni pijesak ili slične grube materijale, jer oštećuju površinu koja potom postane mutna.

Proizvodi osnovne sanitarne opreme od kompozitnoga materijala odgovaraju internome standardu GNOS 19, čija su osnova međunarodni standardi (ANSI, DIN EN)

Sanitary ware is made of composite material based on ground stones bound with polyester resin.

Resistance

The material is resistant to common cosmetics, disinfectants and cleaning agents. The only exceptions are acids and lye in concentrations exceeding 10%. The material is stain resistant, resilient and hard to fracture. The surface is impermeable and pleasant to the touch.

Maintenance

Products made of composite material may be cleaned by using ordinary liquid detergents. Do not use cleaners containing fine sand or similar abrasive ingredients, as these tend to damage and dull the surface.

Basic sanitary ware products made of composite material comply with the internal standard GNOS 19 based on international standards (ANSI, DIN EN).

Sanitarna oprema je izdelana iz kompozitnega materiala, katerega osnova je mlet kamen, povezan s poliestersko smolo.

Odpornost

Materijal je odporen na delovanje običajnih kozmetičnih, dezinfekcijskih in čistilnih sredstev. Izjema so kisline in lugi v koncentracijah večjih od 10%. Material je neobčutljiv na razne madeže, elastičen in težko lomljiv. Površina je nepropustna in prijetna na dotik.

Vzdrževanje

Za čiščenje izdelkov iz kompozitnega materiala lahko uporabljamo običajna tekoča čistilna sredstva. Ne uporabljajte čistil, ki vsebujejo drobno mleti pesek ali podobne grobe materiale, saj poškodujejo površino in ta postane motna. Izdelki osnovne sanitarne opreme iz umetnega marmorja odgovarjajo internemu standardu GNOS 19, ki ima za osnovo mednarodne standarde (ANSI, DIN EN).

Die Sanitäreinrichtung ist aus Kompositmaterial hergestellt, dessen Basis ist der gemahlene Stein mit Kunstharz gebunden.

Beständigkeit

Das Material ist gegen Wirkung der üblichen kosmetischen, Desinfektions- und Reinigungsmittel beständig. Die Ausnahme sind nur die Säuren und Laugen in Konzentrationen höher als 10%. Das Material ist unempfindlich gegen verschiedene Flecken, es ist elastisch und nahezu bruchstabil. Die Oberfläche ist undurchlässig und berührungsangenehm.

Wartung

Produkte aus Kompositmaterial können mit üblichen flüssigen Reinigungsmitteln gereinigt werden. Die Anwendung der Reinigungsmittel mit feingemahlenem Sand oder ähnlichen Grobmaterialien ist nicht zulässig, denn die Oberfläche kann beschädigt und glanzlos werden. Die Elemente der Sanitäreinrichtung aus Kompositmaterial entsprechen dem internen Standard GNOS 19, der auf dem internationalen Standard (ANSI, DIN EN) basiert.

Čista resnica: za bakterije ni prostora

Čista istina: nema mjesta za bakterije

Pure truth: no room for bacteria

Die reine Wahrheit: kein Platz für Bakterien



◀ **Brez skrbi: tudi vaši najmlajši bodo v kopalnici Gorenje varnejši.**

Sanitarna oprema je izdelana iz materiala, čigar receptura zagotavlja izjemno antibakteriološko delovanje površine. Na popolnoma nepropustni in za madeže neobčutljivi površini se pod vplivom vode izločajo ioni, ki preprečujejo rast in razmnoževanje bakterij, kar je dokazano s certifikatom Sanitized®. Učinkovitost je zagotovljena skozi vso življenjsko dobo sanitarne opreme.

Bez brige: u kupaonici Gorenje biti će i vaši najmlađi sigurniji.

Sanitarna je oprema proizvedena od materijala čija receptura osigurava iznimno protubakterijsko djelovanje površine. Na potpuno nepropusnoj i na mrlje neosjetljivoj površini pod utjecajem vode izlučuju se ioni koji sprečavaju rast i razmnožavanje bakterija, što je dokazano certifikatom Sanitized®. Učinkovitost je zajamčena za cijeli životni vijek sanitarne opreme.

No worries: Even the youngest of your children will be safer in a Gorenje bathroom.

Sanitary ware is made of material whose composition gives the surface exceptional antibacterial properties. On the totally impermeable and stain resistant surface and under the influence of water, ions are released to prevent bacterial growth and multiplication, which is confirmed by the Sanitized® certificate. Efficiency is guaranteed throughout the entire service life of the sanitary ware.

Ohne Sorgen: auch Ihre Kleinsten werden im Gorenje Badezimmer sicherer sein.

Das zur Herstellung der Sanitäreinrichtung verwendete Material garantiert die hervorragende antibakteriologische Wirkung der Oberfläche. Auf der wasser- und fleckenbeständigen Oberfläche können die Bakterien durch die Wirkung der freigelassenen Ionen nicht wachsen und sich vermehren. Das ist durch das erworbene Zertifikat Sanitized® nachgewiesen. Diese Wirksamkeit bleibt über die ganze Lebensdauer der Sanitäreinrichtung unverändert.



Označevanje odpiranja vrat / Označevanje otvaranja vrata
Door opening direction / Bezeichnung für die Öffnungsrichtung von Türen

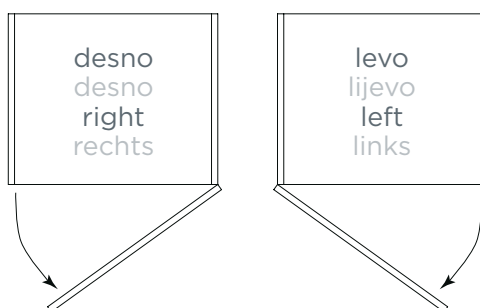

Označevanje dimenzij / Označavanje mjera / Dimensions / Bezeichnung für die Dimensionen

A / B / C
35 / 145 / 33
širina / višina / globina

A / B / C
35 / 145 / 33
širina / visina / dubina

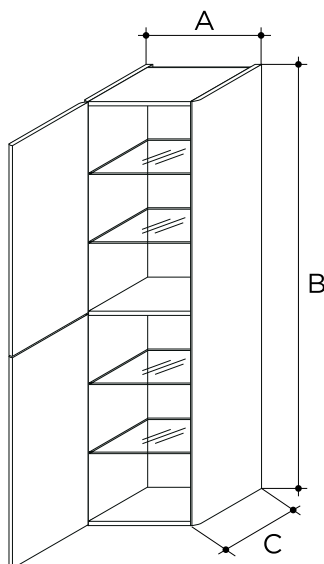

A / B / C
35 / 145 / 33
width / height / depth

A / B / C
35 / 145 / 33
Breite / Höhe / Tiefe

Dodatna oprema / Dodatna oprema / Accessories / Zusatzprogramm

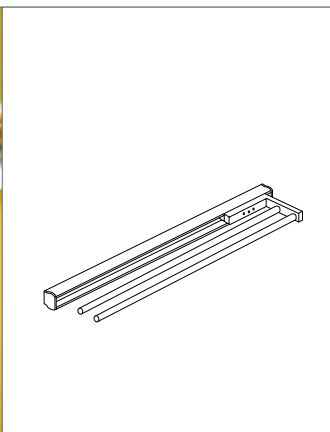

OB 0.08
Obešalnik brisač
Držac ručnika
Towel rail
Handtuchhalter
22,70 PT *

Drobni sanitarni set / Sitni sanitarni komplet Miscellaneous bathroom accessories / Kleiner Sanitärset

• SMART / SMART / SMART / SMART



NŠ 0.04
Nosilec ščetk
Nosáč četkica
Toothbrush holder
Bürstenhalter
66,20 PT *



NM 0.06
Nosilec mila
Nosáč sapuna
Soap holder
Seifenhalter
66,13 PT *



NM 0.07
Nosilec mila
Nosáč sapuna
Soap holder
Seifenhalter
120,95 PT *



NP 0.04
Nosilec papirja
Nosáč papira
Toilet paper roll holder
Papierträger
66,15 PT *



OB 0.14
Obešalnik brisač 40 cm
Držac ručnika 40 cm
Towel rail 40 cm
Handtuchhalter 40 cm
118,95 PT *



OB 0.15
Obešalnik brisač 60 cm
Držac ručnika 60 cm
Towel rail 60 cm
Handtuchhalter 60 cm
124,23 PT *



OK 0.01
Kozmetično ogledalo
Kozmetično ogledalo
Mirror
Kosmetikspiegel
112,85 PT *



PM 0.04
Posoda z WC ščetko
Posuda s WC četkom
Toilet brush set
Behälter für WC Bürste
172,75 PT *





RAZSTAVLJENO KOPALNIŠKO POHIŠTVO

Izberite razstavljeno in bodite soustvarjalec podobe vaše kopalnice.
Naj nastane prav takšna, kakršno ste želeli.

RASTAVLJENI NAMJEŠTAJ ZA KUPAONICE

Odaberite rastavljeno i budite kodizajner izgleda vaše kupaonice. Neka nastane upravo
onakva kakvu ste željeli.



UNASSEMBLED BATHROOM FURNITURE

Select unassembled items and take part in creating your bathroom's appearance. Make it just the way you wanted it to be.

BADEZIMMER - ZERLEGBARE MÖBEL

Wählen Sie die zerlegbare Möbel und seien Sie Mitgestalter Ihres Badezimmers. Es soll ganz nach Ihren Vorstellungen werden.



Catania 96



Corner 97



Compact 98



Ergo 102



Jana 103



Monet 104



Natura 106



Orion 107



Tango 112



Quadra 116

CATANIA



BKG 125.03

- umivalnik 90 cm z nosilcem za brisače
- element pod umivalnikom 90 cm (3 vrata)
- spodnji element 35 cm (1 vrata, 2 predala)
- zgornji element 35 cm (1 vrata)
- zgornji element 20 cm (1 vrata)
- ogledalo 70 cm
- polica 70 cm s halogenskimi svetili, stikalom in vtičnico
- segment ogledala 20 cm
- umivaonik 90 cm s držačem ručnika
- element ispod umivaonika 90 cm (3 vrata)
- donji element 35 cm (1 vrata, 2 ladice)
- gornji element 35 cm (1 vrata)
- gornji element 20 cm (1 vrata)
- ogledalo 70 cm
- polica 70 cm s halogenskim svjetlima, prekidačem i utičnicom
- segment ogledala 20 cm
- 90 cm basin with towel rail
- vanity cabinet (three doors), 90 cm
- base cabinet (1 door, 2 drawers), 35 cm
- wall cabinet (1 door), 35 cm
- wall cabinet (1 door), 20 cm
- mirror, 70 cm
- shelf with halogen light fittings, switch and power outlet, 70 cm
- mirror panel, 20 cm
- Waschbecken 90 cm mit Handtuchhalter
- Waschbeckenunterschrank 90 cm (3 Türen)
- Unterschrank 35 cm (1 Tür, 2 Schubladen)
- Wandschrank 35 cm (1 Tür)
- Wandschrank 20 cm (1 Tür)
- Spiegel 70 cm
- Ablage 70 cm mit Halogenleuchten, Schalter und Stecker
- Spiegelsegment 20 cm

576,29 PT *

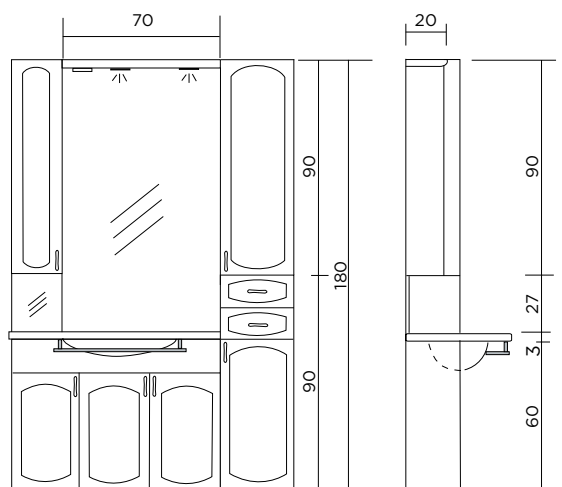

Vrata: oplaščena vlaknena plošča (MDF) v visokem sijaju: bela

Obod: oplemenitena iverna ploščica: bela sijaj

Vrata: obložena vlaknatica (MDF) u visokome sjaju: bijela

Obod: oplemenjena iverica: bijela sjaj

Door: foiled fibreboard (MDF) with high-gloss finish: white

Body: laminated particle board: white gloss

Front: Faserplatte (MDF) Hochglanz foliert: Weiß

Korpus: Kunststoffoberfläche: Weiß Glanz

CORNER

**BKG 78.01**

- umivalnik 55 x 55 cm
- element pod umivalnikom z zaobljenimi vrati (dvoje vrat)
- zgornji element z ogledalom (1 vrata z ogledalom)
- umivaonik 55 x 55 cm
- element ispod umivaonika sa zaobljenim vratima (dvoje vrata)
- gornji element s ogledalom (1 vrata s ogledalom)
- basin, 55 x 55 cm
- vanity cabinet with rounded door corners (two doors)
- wall cabinet with mirror (1 mirror door)
- Waschbecken 55 x 55 cm
- Waschbeckenunterschrank mit abgerundeter Tür (zwei Türen)
- Wandschrank mit Spiegel (1 Spiegeltür)

Vrata: vlaknena plošča (MDF), lakirana s kakovostnim belim lakom

Obod: bela oplemenitena iverna plošča

Vrata: vlaknatica (MDF), lakirana kvalitetnim bijelim lakom

Obod: bijela oplemenjena iverica

Door: varnished fibreboard (MDF) in quality white finish

Body: white laminated particle board

Front: Faserplatte (MDF), hochwertiger Lack, Weiß

Korpus: Kunststoffoberfläche, Weiß
327,21 PT *

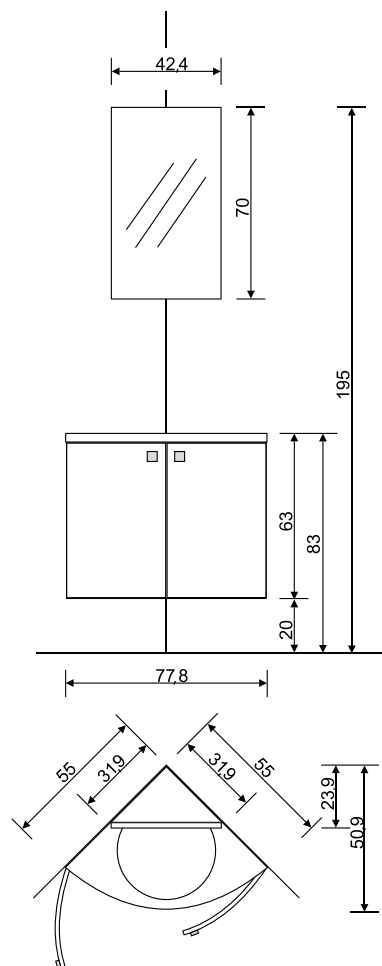

* Cena v točkah / Cijena u točkama
Price in points / Preis in Punkten

COMPACT



BKG 70.14 + E 30.86

Vrata:
oplašćena vlaknena plošća (MDF) v
visokem sijaju: bela

Obod:
oplemenitena iverna plošća: bela sijaj

Vrata:
obložena vlaknatica (MDF) u visokome
sjaju: bijela

Obod:
oplemenjena iverica: bijela sjaj



BKG 100.01

COMPACT



BKG 80.01



BKG 60.01



Door:
foiled fibreboard (MDF) with high-gloss finish: white

Body:
laminated particle board: white gloss

Front:
Faserplatte (MDF) Hochglanz foliert: Weiß

Korpus:
Kunststoffoberfläche: Weiß Glanz

COMPACT

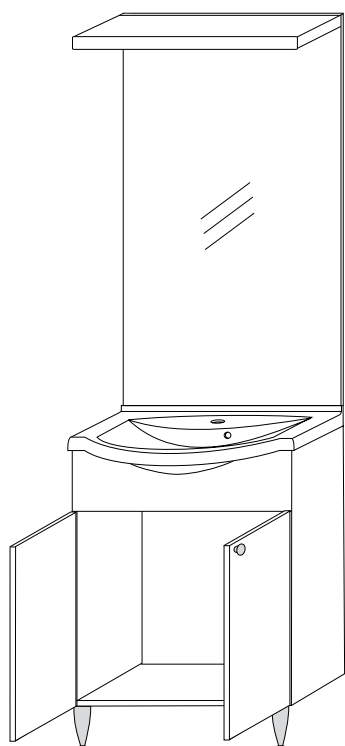

BKG 60.01

- umivalnik 60 cm
 - element pod umivalnikom 60 cm (dvoje vrat)
 - ogledalo 60 cm
 - polica 60 cm s halogenskimi svetili, stikalom in vtičnico
 - umivaonik 60 cm
 - element ispod umivaonika 60 cm (dvoje vrata)
 - ogledalo 60 cm
 - polica 60 cm s halogenskim svjetlima, prekidačem i utičnicom
 - basin 60 cm
 - vanity cabinet (two doors), 60 cm
 - mirror 60 cm
 - shelf with lights, switch and power outlet, 60 cm
 - Waschbecken 60 cm
 - Waschbeckenunterschrank 60 cm (zwei Türen)
 - Spiegel 60 cm
 - Ablage 60 cm mit Halogenleuchten, Schalter und Stecker
- 60/194/30(48,5)
285,43 PT *

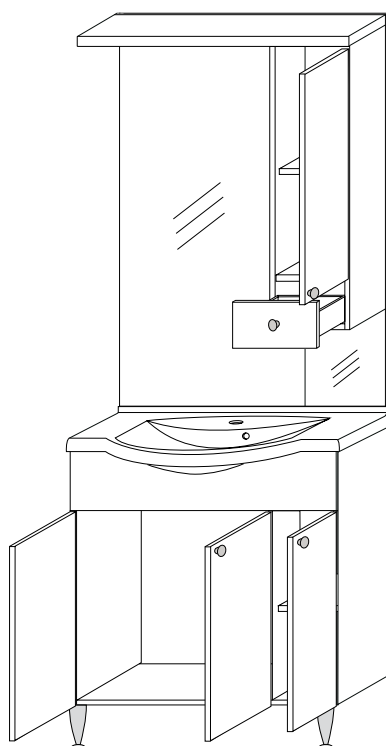

BKG 70.14

- umivalnik 70 cm
 - element pod umivalnikom 70 cm (3 vrata)
 - zgornji element 20 cm (1 vrata, 1 sipnica), ogledalo 50 cm, segment ogledala 20 cm
 - polica 70 cm s halogenskimi svetili, stikalom in vtičnico
 - umivaonik 70 cm
 - element ispod umivaonika 70 cm (3 vrata)
 - gornji element 20 cm (1 vrata, 1 ladica), ogledalo 50 cm, segment ogledala 20 cm
 - polica 70 cm s halogenskim svjetlima, prekidačem i utičnicom
 - basin 70 cm
 - vanity cabinet (three doors), 70 cm
 - wall cabinet 20 cm (1 door, 1 drawer), mirror 50 cm, mirror panel 20 cm
 - shelf with lights, switch and power outlet, 70 cm
 - Waschbecken 70 cm
 - Waschbeckenunterschrank 70 cm (3 Türen)
 - Wandschrank 20 cm (1 Tür, 1 Schubkasten), Spiegel 50 cm, Spiegelsegment 20 cm
 - Ablage 70 cm mit Halogenleuchten, Schalter und Stecker
- 70/194/30(48,5)
357,85PT *

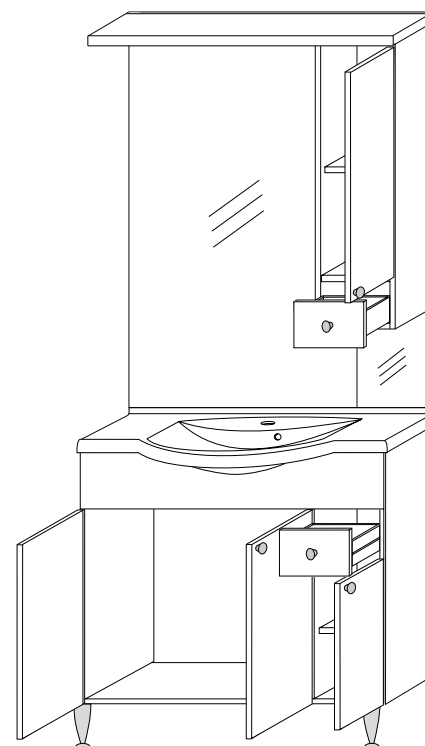

BKG 80.01

- umivalnik 80 cm
 - element pod umivalnikom 80 cm (3 vrata, 1 predal)
 - zgornji element 20 cm (1 vrata, 1 sipnica), ogledalo 60 cm, segment ogledala 20 cm
 - polica 80 cm s halogenskimi svetili, stikalom in vtičnico
 - umivaonik 80 cm
 - element ispod umivaonika 80 cm (3 vrata, 1 ladica)
 - gornji element 20 cm (1 vrata, 1 ladica), ogledalo 60 cm, segment ogledala 20 cm
 - polica 80 cm s halogenskim svjetlima, prekidačem i utičnicom
 - basin 80 cm
 - vanity cabinet (three doors, 1 drawer), 80 cm
 - wall cabinet 20 cm (1 door, 1 drawer), mirror 60 cm, mirror panel 20 cm
 - shelf with lights, switch and power outlet, 80 cm
 - Waschbecken 80 cm
 - Waschbeckenunterschrank 80 cm (3 Türen, 1 Schubkasten)
 - Wandschrank 20 cm (1 Tür, 1 Schubkasten), Spiegel 60 cm, Spiegelsegment 20 cm
 - Ablage 80 cm mit Halogenleuchten, Schalter und Stecker
- 80/194/30(48,5)
392,75 PT *

COMPACT

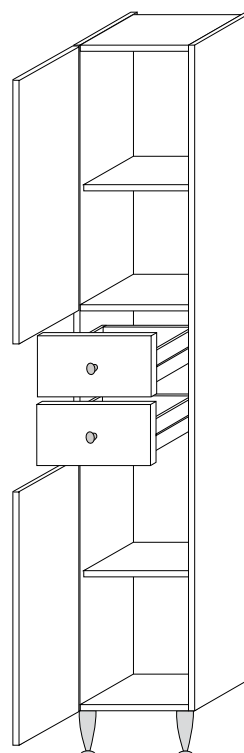
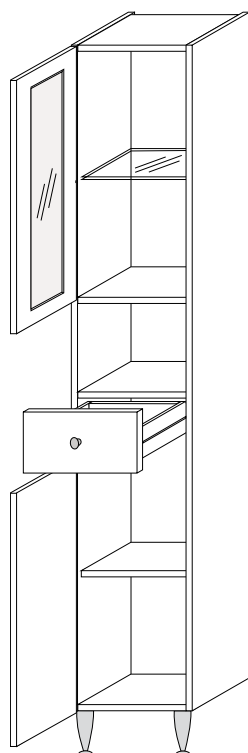
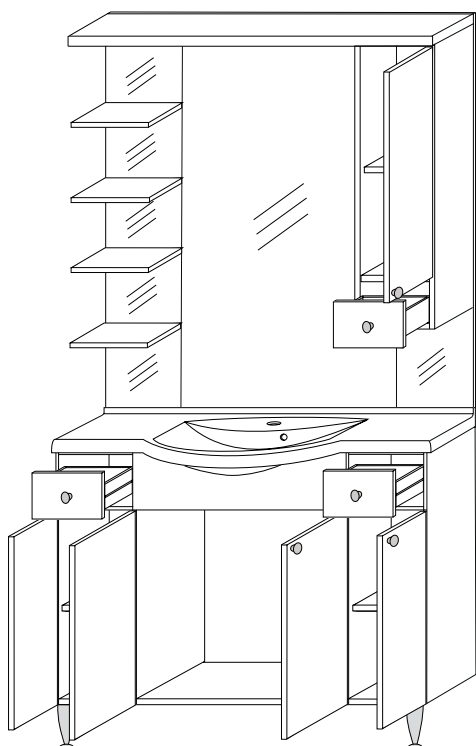

BKG 100.01

- umivalnik 100 cm
- element pod umivalnikom 100 cm (4 vrata, 2 predala)
- zgornji element 20 cm (1 vrata, 1 sipnica), ogledalo 60 cm, segment ogledala 20 cm
- zgornji panel 20 cm z ogledali in policami
- polica 100 cm s halogenskimi svetili, stikalom in vtičnico
- umivaonik 100 cm
- element ispod umivaonika 80 cm (4 vrata, 2 ladice)
- gornji element 20 cm (1 vrata, 1 ladica), ogledalo 60 cm, segment ogledala 20 cm
- gornji panel 20 cm s ogledalima i policama
- polica 100 cm s halogenskim svjetlima, prekidačem i utičnicom
- basin 100 cm
- vanity cabinet (4 doors, 2 drawers), 100 cm
- wall cabinet 20 cm (1 door, 1 drawer), mirror 60 cm, mirror panel 20 cm
- shelf unit with mirrors, 20 cm
- shelf with lights, switch and power outlet, 100 cm
- Waschbecken 100 cm
- Waschbeckenunterschrank 100 cm (4 Türen, 2 Schubkästen)
- Wandschrank 20 cm (1 Tür, 1 Schubkasten), Spiegel 60 cm, Spiegelsegment 20 cm
- Spiegelpaneel 20 cm mit Ablagen
- Ablage 100 cm mit Halogenleuchten, Schalter und Stecker 100/194/30(48,5)

463,06 PT *

E 30.86 L,D

- Visoka omara L,D (1 vrata, 1 steklena vrata, 1 predal, 1 niša)
- Visoki ormar L,D (1 vrata, 1 vrata sa staklom, 1 ladica, 1 niša)
- Tall cabinet L,R (1 door, 1 glass door, 1 drawer, 1 recess)
- Hochschrank L,R (1 Tür, 1 Glastür, 1 Schublade, 1 Nische) 30/194/30

149,70 PT *

E 30.82 L,D

- Visoka omara L,D (dvoje vrat, 2 predala)
- Visoki ormar L,D (2 vrata, 2 ladice)
- Tall cabinet L,R (2 doors, 2 drawers)
- Hochschrank L,R (2 Türen, 2 Schubladen) 30/194/30

141,69 PT *

ERGO



BKG 140.16 L,D (L,R)

- umivalnik 105 cm
- element pod umivalnikom 70 cm (dvoje vrat)
- spodnji element 35 cm (1 vrata)
- spodnji element 35 cm (1 vrata, 1 košara, 2 predala)
- odlagalna polica 35,2 cm
- zgornji element 35 cm z ogledali in policami
- zgornji element 35 cm (1 vrata)
- ogledalo 70 x 90 cm
- polica pod ogledalom 70 cm
- polica 70 cm s halogenskimi svetili, stikalom in vtičnico

* V levi in desni izvedbi

- umivaonik 105 cm
- element ispod umivaonika 70 cm (dvoje vrata)
- donji element 35 cm (1 vrata)
- donji element 35 cm (1 vrata, 1 košara, 2 ladice)
- polica za odlaganje
- gornji element 35 cm s ogledalima i policama
- gornji element 35 cm (1 vrata)
- ogledalo 70 x 90 cm
- polica ispod ogledala 70 cm
- polica 70 cm sa svjetlima, prekidačem i utičnicom

* U lijevoj i desnoj izvedbi

- basin, 105 cm
- vanity cabinet (two doors), 70 cm
- base cabinet (1 door), 35 cm
- base cabinet (1 door, 1 laundry basket, 2 drawers), 35 cm
- functional shelf
- shelf unit with mirrors, 35 cm
- wall cabinet (1 door), 35 cm
- mirror 70 x 90 cm
- mirror shelf, 70 cm
- shelf with lights, switch and power outlet, 70 cm

* Option of left or right hand version

- Waschbecken 105 cm
- Waschbeckenunterschrank 70 cm (zwei Türen)
- Unterschrank 35 cm (1 Tür)
- Unterschrank 35 cm (1 Tür, 1 Korb, 2 Schubladen)
- Ablage
- Spiegelpaneel 35 cm mit Ablagen
- Wandschrank 35 cm (1 Tür)
- Spiegel 70 x 90 cm
- Ablage 70 cm unter dem Spiegel
- Ablage 70 cm mit Leuchte, Schalter und Stecker

* In linker und rechter Ausführung

614,04 PT *

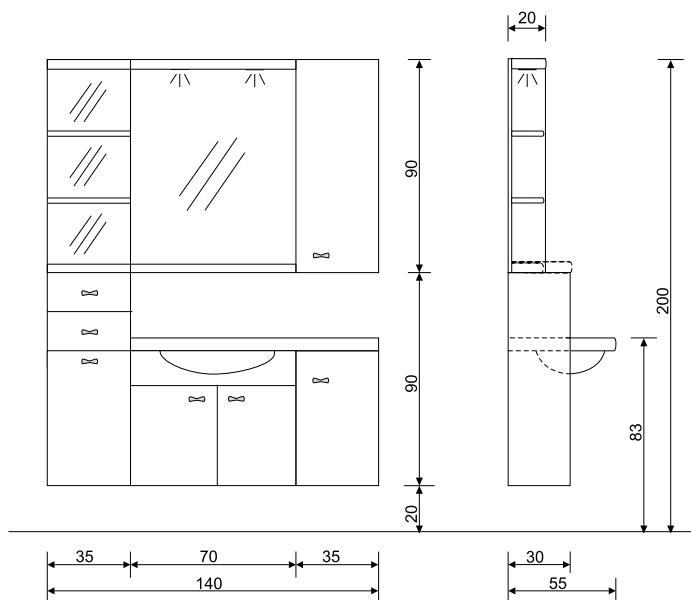

Vrata: oplašćena vlaknena plošća (MDF) v visokem sijaju: bela

Obod: oplemenitena iverna plošća: bela sijaj

Vrata: obložena vlaknatica (MDF) u visokome sjaju: bijela

Obod: oplemenjena iverica: bijela sjaj

Door: foiled fibreboard (MDF) with high-gloss finish: white

Body: laminated particle board: white gloss

Front: Faserplatte (MDF) Hochglanz foliert: Weiß

Korpus: Kunststoffoberfläche: Weiß Glanz

JANA

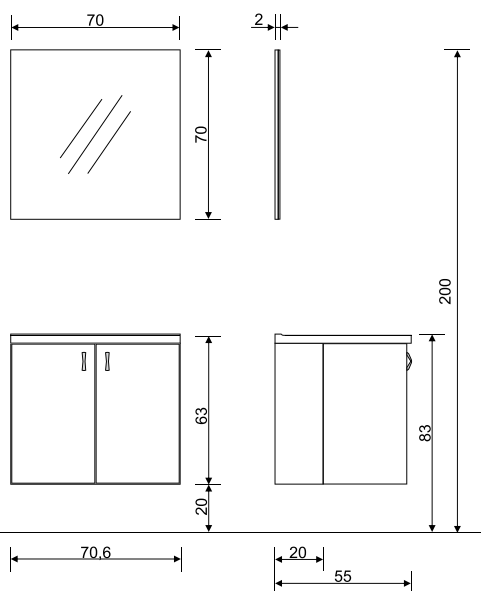

BKG 70.21

- umivalnik 70 cm
- element pod umivalnikom 70 cm z zaobljenimi vrati (dvoje vrat)
- ogledalo 70 x 70 cm
- umivaonik 70 cm
- element ispod umivaonika 70 cm sa zaobljenim vratima (dvoje vrata)
- ogledalo 70 x 70 cm

292,24 PT *

- basin, 70 cm
- vanity cabinet with rounded door corners (two doors), 70 cm
- mirror, 70 x 70 cm
- Waschbecken 70 cm
- Waschbeckenunterschrank 70 cm mit abgerundeter Tür (zwei Türen)
- Spiegel 70 x 70 cm

Vrata: vlaknena plošča (MDF), lakirana s kakovostnim belim lakom

Obod: bela oplemenitena iverna plošča

Vrata: vlaknatica (MDF), lakirana kvalitetnim bijelim lakom

Obod: bijela oplemenjena iverica

Door: varnished fibreboard (MDF) in quality white finish

Body: white laminated particle board

Front: Faserplatte (MDF), hochwertiger Lack, Weiß

Korpus: Kunststoffoberfläche, Weiß

MONET



Vrata: opláščena vlaknena plošča (MDF) v visokem sijaju: bela

Obod: oplemenitena iverna plošča: bela sijaj

Vrata: obložena vlaknatica (MDF) u visokom sjaju: bijela

Obod: oplemenjena iverica: bijela sjaj

Door: foiled fibreboard (MDF) with high-gloss finish: white

Body: laminated particle board: white gloss

Front: Faserplatte (MDF) Hochglanz foliert: Weiß

Korpus: Kunststoffoberfläche: Weiß Glanz



MONET

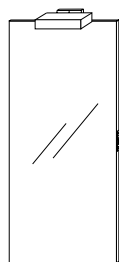

Ogledalo 40x100 cm s svetilko
Ogledalo 40x 100 cm sa svjetiljkom
Mirror 40x 100 cm with light fitting
Spiegel 40x 100 mit Leuchte
126,08 PT *

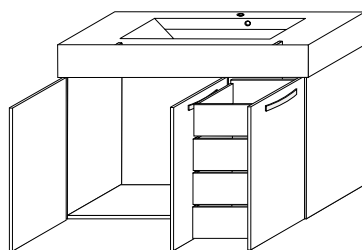

BKG 100.44
• Umivalnik UM 100.179
Umivaonik UM 100.179
Basin UM 100.179
Waschbecken UM 100.179
100,2/12/46
• Element pod umivalnikom F 100.07
Element ispod umivaonika F 100.07
Vanity cabinet F 100.07
Waschbeckenunterschrank F 100.07
100/60/45
309,55 PT *

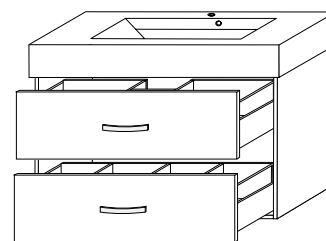

BKG 100.45
• Umivalnik UM 100.179
Umivaonik UM 100.179
Basin UM 100.179
Waschbecken UM 100.179
100,2/12/46
• Element pod umivalnikom F 100.08
Element ispod umivaonika F 100.08
Vanity cabinet F 100.08
Waschbeckenunterschrank F 100.08
100/60/45
255,32 PT *

Priporočeni dodatni elementi** / Preporučljivi dodatni elementi** Recommended additional cabinets** / Die empfohlenen Zusatzelemente**

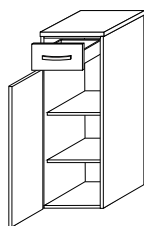

BKG 30.16 L,D**
Spodnji element s pokrivno ploščo L,D
Donji element s pokrivnom pločom L,D
Base cabinet with functional top L,R
Unterschrank mit Deckplatte L,R
• 30,3/92,8/36
143,81 PT *

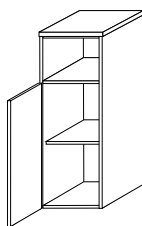

BKG 30.19 L,D**
Spodnji element s pokrivno ploščo L,D
Donji element s pokrivnom pločom L,D
Base cabinet with functional top L,R
Unterschrank mit Deckplatte L,R
• 30,3/92,8/36
61,03 PT *

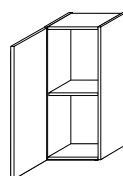

B 30.01 L,D**
Viseći element L,D
Viseći element L,D
Wall cabinet L,R
Wandschrank L,R
• 30/60/20
36,92 PT *

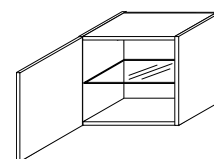

B 45.10 L,D**
Kocka L,D
Kocka L,D
Cube L, R
Würfel L,R
• 45/45/18
108,74 PT *

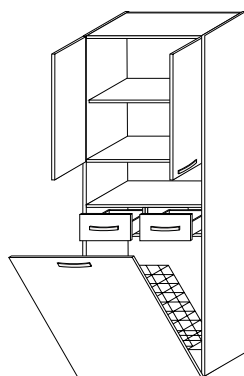

E 60.63**
Visoka omara
Visoki ormar
Tall cabinet
Hochschrank
• 60/180/35
375,23 PT *

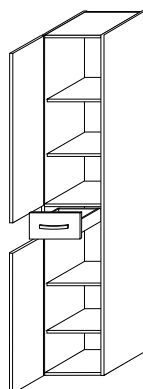

E 30.06 L,D**
Visoka omara L,D
Visoki ormar L,D
Tall cabinet L,R
Hochschrank L,R
• 30/180/35
253,43 PT *

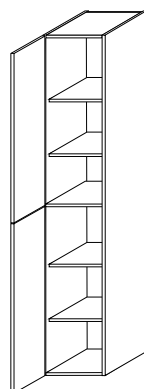

E 30.05 L,D**
Visoka omara L,D
Visoki ormar L,D
Tall cabinet L,R
Hochschrank L,R
• 30/180/35
185,87 PT *

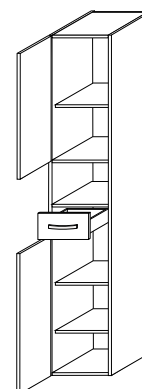

E 30.63 L,D**
Visoka omara L,D
Visoki ormar L,D
Tall cabinet L,R
Hochschrank L,R
• 30/180/35
222,05 PT *

* Cena v točkah / Cijena u točkama / Price in points / Preis in Punkten

** Elementi so sestavljeni / Elementi su sastavljeni / The cabinets are assembled / Es sind die Anbauelemente

NATURA



BKG 70.22

- umivalnik 70 cm (Soligor Polar)
 - element pod umivalnikom 70 cm (dvoje vrat, 1 predal, 4 nogice v Alu dekorju)
 - ogledalo 70 x 112,5 cm s polico in svetilko
 - umivaonik 70 cm (Soligor Polar)
 - element ispod umivaonika 70 cm (dvoje vrata, 1 ladica, 4 nogice u Alu dekoru)
 - ogledalo 70 x 112,5 cm s policom i svjetiljkom
 - basin, 70 cm (Soligor Polar)
 - vanity cabinet (two doors, one drawer, 4 feet in alu finish), 70 cm
 - mirror with shelf and light fitting, 70 x 112.5 cm
 - Waschbecken 70 cm (Soligor Polar)
 - Waschbeckenunterschrank 70 cm (Doppeltür, 1 Schublade, 4 FüÙe in Alu Dekor)
 - Spiegel 70 x 112,5 cm mit Ablage und Leuchte
- 516,65 PT *

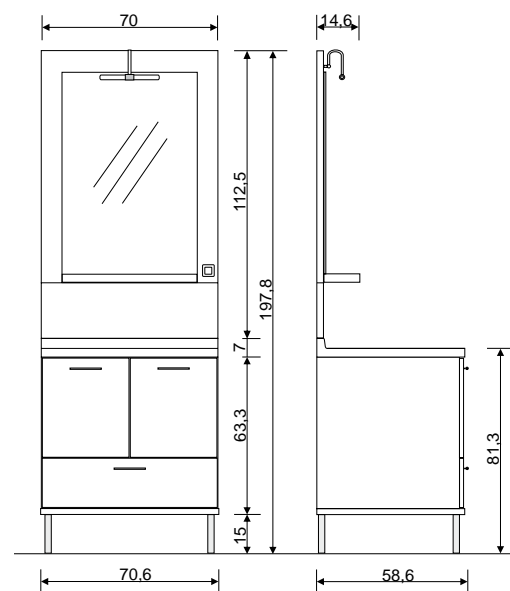

Vrata in obod: oplemenitena iverna plošča v dekorju unilin in svetel hrast

Vrata i obod: oplemenjena iverica u dekoru unilin i svijetli hrast

Door and body: laminated particle board in UNILIN finish and bright oak finish

Front und Korpus: Kunststoffoberfläche, Dekor Unilin und helle Eiche



ORION



ORION



BKG 150.10



BKG 60.34 + BKG 60.29



BKG 90.19 L + BKG 50.05

Vrata / Vrata / Door / Front

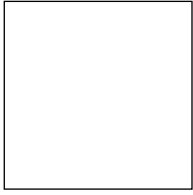
Akcentne barve vrat / Akcentne boje vrata
Accent door colours / Akzentfarbe der Türe

bela visok sijaj
bijela visoki sjaj
white high gloss
Weiß Hochglanz



jablana
jablan
appletree
Apfelbaum



oreh temni
orah tamni
walnut dark
Nuß dunkel



wenge
wenge
wenge
Wenge

Vrata:

- oplasčena vlaknena plošča (MDF): bela visok sijaj
- oplemenitena iverna plošča: jablana, oreh temni, wenge

Pokrivna polica:

- oplasčena vlaknena plošča (MDF): bela visok sijaj
- oplemenitena iverna plošča: jablana, oreh temni, wenge

Ličnice predalov na elementih pod umivalnikom:

- oplasčena vlaknena plošča (MDF): bela visok sijaj

Vrata:

- obložena vlaknatica (MDF): bijela, visoki sjaj
- oplemenjena iverica: jablan, orah tamni, wenge

Pokrovna polica:

- obložena vlaknatica (MDF): bijela visoki sjaj
- oplemenjena iverica: jablan, orah tamni, wenge

Maske ladica na elementima ispod umivaonika:

- obložena vlaknatica (MDF): bijela, visoki sjaj

Door:

- foiled fibreboard (MDF): white high gloss
- laminated particle board: appletree, walnut dark, wenge

Countertop:

- foiled fibreboard (MDF): white high gloss
- laminated particle board: appletree, walnut dark, wenge

Drawer front panels on vanity cabinets:

- varnished fibreboard (MDF): white high gloss

Front:

- Faserplatte (MDF): Weiß Hochglanz
- Kunststoffoberfläche: Apfelbaum, Nuß dunkel, Wenge

Deckplatte:

- Faserplatte (MDF): Weiß Hochglanz
- Kunststoffoberfläche: Apfelbaum, Nuß dunkel, Wenge

Ladeblenden an den Waschbecken-Unterschrank:

- Faserplatte (MDF): Weiß Hochglanz

Obod / Obod / Body / Korpus

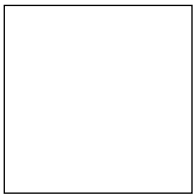

bela sijaj
bijela sjaj
white gloss
Weiß Glanz



jablana
jablan
appletree
Apfelbaum



oreh temni
orah tamni
walnut dark
Nuß dunkel



wenge
wenge
wenge
Wenge

Obod:

- oplemenitena iverna plošča: bela sijaj
- oplemenitena iverna plošča: jablana, oreh temni, wenge

Obod:

- oplemenjena iverica: bijela sjaj
- oplemenjena iverica: jablan, orah tamni, wenge

Body:

- laminated particle board: white gloss
- laminated particle board: appletree, walnut dark, wenge

Korpus:

- Kunststoffoberfläche: Weiß Glanz
- Kunststoffoberfläche: Apfelbaum, Nuß dunkel, Wenge

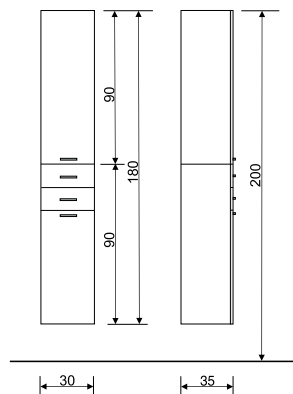
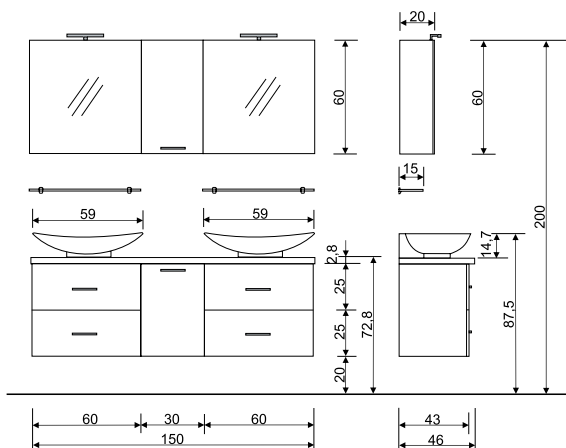

ORION

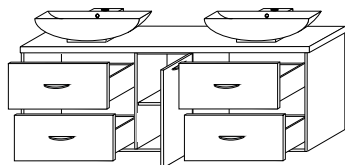
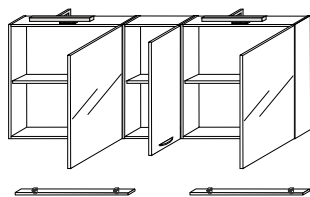

BKG 150.09

- umivalnik 59 cm / 2x
- pokrivna polica 150,5 cm / 1x
- element pod umivalnikom 60 cm (2 izvlečna predala) / 2x
- spodnji element 30 cm (1 vrata) / 1x
- zgornji element 30 cm (1 vrata) / 1x
- zgornji element 60 cm z ogledalom in svetilko / 2x
- steklena odlagalna polica 60x15 cm / 2x
- umivaonik 59 cm / 2x
- pokrovna polica 150,5 cm / 1x
- element ispod umivaonika 60 cm (2 ladice na izvlačenje) / 2x
- donji element 30 cm (1 vrata) / 1x
- gornji element 30 cm (1 vrata) / 1x
- gornji element 60 cm s ogledalom i svjetiljkom / 2x
- staklena polica za odlaganje 60x15 cm / 2x

1.150,64 PT *

- basin, 59 cm / 2x
- countertop, 150.5 cm / 1x
- vanity cabinet (2 pull-out drawers), 60 cm / 2x
- base cabinet (1 door), 30 cm / 1x
- wall cabinet (1 door), 30 cm / 1x
- wall cabinet with mirror and light, 60 cm / 2x
- glass shelf, 60x15 cm / 2x
- Waschbecken 59 cm / 2x
- Deckplatte 150,5 cm / 1x
- Waschbeckenunterschrank 60 cm (2 Ausziehschubladen) / 2x
- Unterschrank 30 cm (1 Tür) / 1x
- Wandschrank 30 cm (1 Tür) / 1x
- Wandschrank 60 cm mit Spiegel und Leuchten / 2x
- Glasablage 60x15 cm / 2x

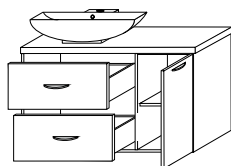
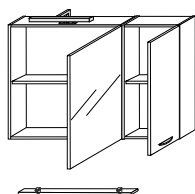

BKG 90.20 L, D (L, R)

- umivalnik 59 cm
- pokrivna polica 90,3 cm
- element pod umivalnikom 60 cm (2 izvlečna predala)
- spodnji element 30 cm (1 vrata)
- zgornji element 30 cm (1 vrata)
- zgornji element 60 cm z ogledalom in svetilko
- steklena odlagalna polica 60x15 cm
- umivaonik 59 cm
- pokrovna polica 90,3 cm
- element ispod umivaonika 60 cm (2 ladice na izvlačenje)
- donji element 30 cm (1 vrata)
- gornji element 30 cm (1 vrata)
- gornji element 60 cm s ogledalom i svjetiljkom
- staklena polica za odlaganje 60x15 cm

687,78 PT *

- basin, 59 cm
- countertop, 90.3 cm
- vanity cabinet (2 pull-out drawers), 60 cm
- base cabinet (1 door), 30 cm
- wall cabinet (1 door), 30 cm
- wall cabinet with mirror and light, 60 cm
- glass shelf, 60x15 cm
- Waschbecken 59 cm
- Deckplatte 90,3 cm
- Waschbeckenunterschrank 60 cm (2 Ausziehschubladen)
- Unterschrank 30 cm (1 Tür)
- Wandschrank 30 cm (1 Tür)
- Wandschrank 60 cm mit Spiegel und Leuchte
- Glasablage 60x15 cm

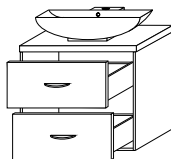
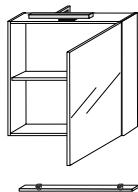

BKG 60.33

- umivalnik 59 cm
- pokrivna polica 60,3 cm
- element pod umivalnikom 60 cm (2 izvlečna predala)
- zgornji element 60 cm z ogledalom in svetilko
- steklena odlagalna polica 60x15 cm
- umivaonik 59 cm
- pokrovna polica 60,3 cm / 1x
- element ispod umivaonika 60 cm (2 ladice na izvlačenje)
- gornji element 60 cm s ogledalom i svjetiljkom
- staklena polica za odlaganje 60x15 cm

512,34 PT *

- basin, 59 cm
- countertop, 60.3 cm / 1x
- vanity cabinet (2 pull-out drawers), 60 cm
- wall cabinet with mirror and light, 60 cm
- glass shelf, 60x15 cm
- Waschbecken 59 cm
- Deckplatte 60,3 cm / 1x
- Waschbeckenunterschrank 60 cm (2 Ausziehschubladen)
- Wandschrank 60 cm mit Spiegel und Leuchte
- Glasablage 60x15 cm

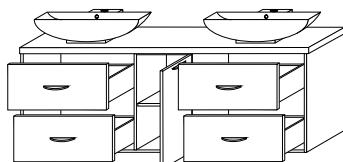
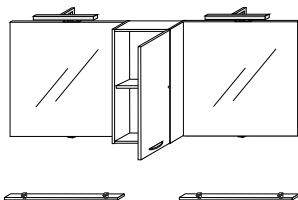

BKG 150.10

- 2 x umivalnik 59 cm
- 2 x element pod umivalnikom 60 cm (2 višja predala)
- spodnji element 30 cm (1 vrata)
- pokrivna polica 150,5 cm (2 x izrez za umivalnik)
- 2 x ogledalo 60 x 60 cm s svetilko
- viseći element 30 cm (1 vrata)
- 2 x steklena polica 60 x 15 cm
- 2 x umivaonik 59 cm
- 2 x element ispod umivaonika 60 cm (2 više ladice)
- donji element 30 cm (1 vrata)
- pokrovna polica 150,5 cm (2 x izrez za umivaonik)
- 2 x ogledalo 60 x 60 cm s svjetiljkom
- viseći element 30 cm (1 vrata)
- 2 x staklena polica 60 x 15 cm

1.043,88 PT *

- 2 x basin, 59 cm
- 2 x vanity cabinet (2 high drawers), 60 cm
- base cabinet (1 door), 30 cm
- countertop (2 x basin cutouts), 150.5 cm
- 2 x mirror 60 x 60 cm with light
- wall-mounted cabinet (1 door), 30 cm
- 2 x glass shelf, 60 x 15 cm
- 2 x Waschbecken 59 cm
- 2 x Waschbeckenunterschrank 60 cm (2 höhere Schubladen)
- Unterschrank 30 cm (1 Tür)
- Deckplatte 150,5 cm (2 x Ausschnitt für Waschbecken)
- 2 x Spiegel 60 x 60 cm mit Leuchte
- Wandschrank 30 cm (1 Tür)
- 2 x Glasablage 60 x 15 cm

ORION

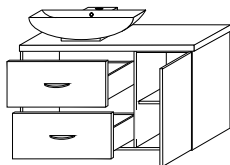
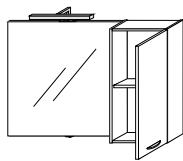

BKG 90.19 L,D (L,R)

- umivalnik 59 cm
- element pod umivalnikom 60 cm (2 višja predala)
- spodnji element 30 cm (1 vrata)
- pokrivna polica 90,3 cm z izrezom za umivalnik
- ogledalo 60 x 60 cm s svetilko
- viseči element 30 cm (1 vrata)
- steklena polica 60 x 15 cm
- umivaonik 59 cm
- element ispod umivaonika 60 cm (2 više ladice)
- donji element 30 cm (1 vrata)
- pokrovna polica 90,3 cm s izrezom za umivaonik
- ogledalo 60 x 60 cm s svjetiljkom
- viseći element 30 cm (1 vrata)
- staklena polica 60 x 15 cm

622,68 PT *

- basin, 59 cm
- vanity cabinet (2 high drawers), 60 cm
- base cabinet (1 door), 30 cm
- countertop with basin cutout, 90,3 cm
- mirror 60 x 60 cm with light
- wall-mounted cabinet (1 door), 30 cm
- glass shelf, 60 x 15 cm

- Waschbecken 59 cm
- Waschbeckenunterschrank 60 cm (2 höhere Schubladen)
- Unterschrank 30 cm (1 Tür)
- Deckplatte 90,3 cm mit Ausschnitt für Waschbecken
- Spiegel 60 x 60 cm mit Leuchte
- Wandschrank 30 cm (1 Tür- Wenge)
- Glasablage 60 x 15 cm

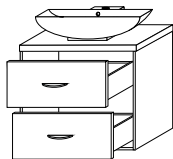
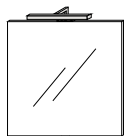

BKG 60.34

- umivalnik 59 cm
- element pod umivalnikom 60 cm (2 višja predala)
- pokrovna polica 60,3 cm z izrezom za umivalnik
- ogledalo 60 x 70 cm s svetilko
- steklena polica 60 x 15 cm
- umivaonik 59 cm
- element ispod umivaonika 60 cm (2 više ladice)
- pokrovna polica 60,3 cm s izrezom za umivaonik
- Ogledalo 60 x 70 cm s svjetiljkom
- staklena polica 60 x 15 cm

463,19 PT *

- basin, 59 cm
- vanity cabinet (2 high drawers), 60 cm
- countertop with basin cutout, 60,3 cm
- mirror 60 x 60 cm with light
- glass shelf, 60 x 15 cm

- Waschbecken 59 cm
- Waschbeckenunterschrank 60 cm (2 höhere Schubladen)
- Deckplatte 60,3 cm mit Ausschnitt für Waschbecken
- Spiegel 60 x 60 cm mit Leuchte
- Glasablage 60 x 15 cm

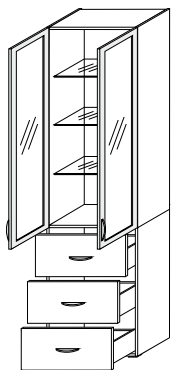

BKG 50.05

Visoka omara
Visoki ormar
Tall cabinet
Hochschrank
• 50/195/35
413,71 PT *

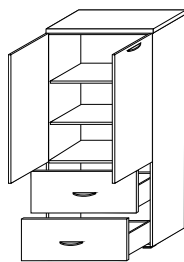

BKG 60.29

Visoka omara s pokrivno ploščo
Visoki ormar s pokrovnom pločom
Tall cabinet with functional top
Highboard mit Abdeckplatte
• 60,3/127,8/36
249,01 PT *



E 30.12 L,D

Visoka omara L,D
Visoki ormar L,D
Tall cabinet L,R
Hochschrank L,R
• 30/180/35
200,18 PT *

TANGO





Tango je linija kopalniškega pohištva čistih, modnih oblik in kakovostnih materialov.

Elementi kvadratastih oblik omogočajo enostavno in funkcionalno kreiranje kopalniškega prostora v svežih barvnih kombinacijah.

Tango je linija namještaja za kupaonice čistih, modernih oblik i kvalitetnih materijala.

Elementi kvadratastih oblika omogočuju jednostavno i funkcionalno kreiranje prostora za kupaonice u svježim obojenim kombinacijama.

Tango is a brand new range of bathroom furniture characterised by clean, trendy lines and quality materials. Square-shaped cabinets lend themselves to easy and functional bathroom design in a variety of the latest colour combinations.

Tango ist eine Linie von Badezimmermöbeln mit glatten, modischen Formen und hochwertigen Materialien. Die Elemente in quadratischen Formen ermöglichen einfache und funktionelle Gestaltung des Badezimmers in frischen Farbkombinationen.

TANGO



bela visok sijaj
bijela visoki sjaj
white high gloss
Weiß, Hochglanz



rdeča
crvena
red
Rot



vanilija
vanilija
vanilla
Vanille

◀ **Vrata:** oplaščena vlaknena (MDF) plošča: bela visok sijaj, rdeča, vanilija

Vrata: obložena vlaknatica (MDF): bijela visoki sjaj, crvena, vanilija

Door: foiled fibreboard (MDF): white high gloss, red, vanilla

Front: beschichtete Faserplatte (MDF): Weiß Hochglanz, rot, Vanille



beljen hrast
bijeljeni hrast
bleached oak
gebleichte Eiche

◀ **Obod:** oplemenitena iverna plošča v strukturi beljenega hrastovega lesa

Obod: oplemenjena iverica u strukturi bijeljenog hrastovog drveta

Cabinet body: laminated particle board in mock bleached oak finish

Korpus: Kunststoffoberfläche, Struktur gebleichtes Eichenholz

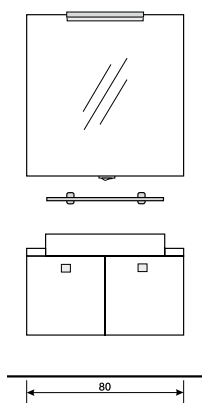
**BKG 80.09**

- umivalnik UM 60.82
- pokrivna polica PO 10.01 / 2x
- element pod umivalnikom F 80.01
- ogledalo 80 x 80 cm
- svetilka Verna s stikalom
- steklena polica 60 x 15 cm
- umivaonik UM 60.82
- pokrovna polica PO 10.01 / 2x
- element ispod umivaonika F 80.01
- ogledalo 80 x 80 cm
- svjetiljka Verna s prekidačem
- staklena polica 60 x 15 cm
- basin UM 60.82
- countertop PO 10.01 / 2x
- vanity cabinet F 80.01
- mirror, 80 x 80 cm
- verno lamp with switch
- glass shelf, 60 x 15 cm
- Waschbecken UM 60.82
- Deckplatte PO 10.01 / 2x
- Waschbeckenunterschrank F 80.01
- Spiegel 80 x 80 cm
- Leuchte Verna mit Schalter
- Glasablage 60 x 15 cm

322,44 PT *

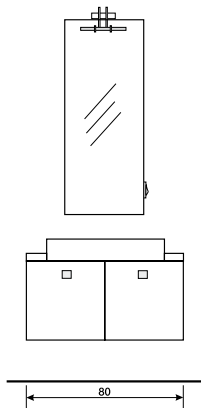
**BKG 80.08**

- umivalnik UM 60.82
- pokrivna polica PO 10.01 / 2x
- element pod umivalnikom F 80.01
- ogledalo 40 x 100 cm
- svetilka Libeccio s stikalom
- umivaonik UM 60.82
- pokrovna polica PO 10.01 / 2x
- element ispod umivaonika F 80.01
- ogledalo 40 x 100 cm
- svjetiljka Libeccio s prekidačem
- basin UM 60.82
- countertop PO 10.01 / 2x
- vanity cabinet F 80.01
- mirror, 40 x 100 cm
- libeccio lamp with switch
- Waschbecken UM 60.82
- Deckplatte PO 10.01 / 2x
- Waschbeckenunterschrank F 80.01
- Spiegel 40 x 100 cm
- Leuchte Libeccio mit Schalter

331,82 PT *

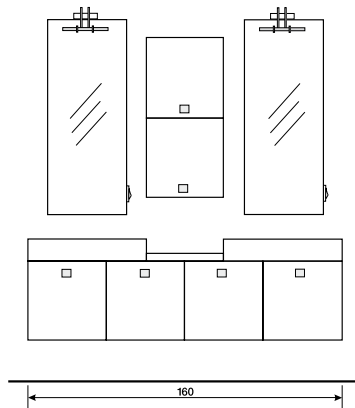
**BKG 160.15**

- umivalnik UM 60.82 / 2x
- pokrivna polica PO 40.01
- element pod umivalnikom F 80.01 / 2x
- zgornji element B 40.02 / 2x
- ogledalo 40 x 100 cm / 2x
- svetilka Libeccio s stikalom / 2x
- umivaonik UM 60.82 / 2x
- pokrovna polica PO 40.01
- element ispod umivaonika F 80.01 / 2x
- gornji element B 40.02 / 2x
- ogledalo 40 x 100 cm / 2x
- svjetiljka Libeccio s prekidačem / 2x

727,20 PT *

- basin UM 60.82 / 2x
- countertop PO 40.01
- vanity cabinet F 80.01 / 2x
- wall cabinet B 40.02 / 2x
- mirror, 40 x 100 cm / 2x
- libeccio lamp with switch / 2x
- Waschbecken UM 60.82 / 2x
- Deckplatte PO 40.01
- Waschbeckenunterschrank F 80.01 / 2x
- Wandschrank B 40.02 / 2x
- Spiegel 40 x 100 cm / 2x
- Leuchte Libeccio mit Schalter / 2x

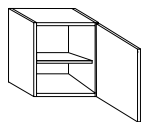
**B 40.02 D,L**

- Zgornji element (1 vrata, 1 polica) / Gornji element (1 vrata, 1 polica) / Wall cabinet (1 door, 1 shelf) / Wandschrank (1 Tür, 1 Ablage)
- 40/40/20

46,03 PT *

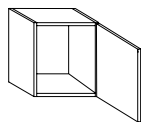
**B 40.01 D,L**

- Spodnji element (1 vrata) / Donji element (1 vrata) / Base cabinet (1 door) / Unterschrank (1 Tür)
- 40/40/35

48,14 PT *

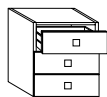
**B 40.03**

- Spodnji element (3 predali) / Donji element (3 ladice) / Base cabinet (3 drawers) / Unterschrank (3 Schubladen)
- 40/40/35

77,27 PT *

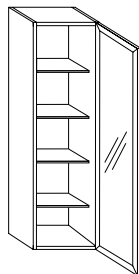
**D 40.01 D,L**

- Visoka omara (1 steklena vrata - Al okvir, 4 steklene police) / Visoki ormar (1 staklena vrata - Al okvir, 4 staklene police) / Tall cabinet (1 glass door, Al frame; 4 glass shelves) / Hochschrank (1 Glastür - Al Rahmen, 4 Glasablagen)
- 40/120/35

139,57 PT *

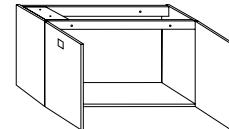
**F 80.01**

- Element pod umivalnikom (dvoje vrat) / Element ispod umivaonika (dvoje vrata) / Vanity cabinet (two doors) / Waschbeckenunterschrank (Doppeltür)
- 80/40/35

79,39 PT *

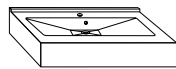
**UM 60.82**

- Umivalnik iz umetnega marmorja v beli barvi / Umivaonik u bijeloj boji basin, white / Waschbecken, Weiß
- 60/12/46

116,11 PT *

**PO 10.01**

- Pokrivna polica / Pokrovna polica / Countertop / Deckplatte
- 10,1/4,4/36

11,52 PT *

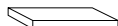
**PO 40.01**

- Pokrivna polica / Pokrovna polica / Countertop / Deckplatte
- 40,2/4,4/36

17,58 PT *



Steklena polica

- Staklena polica / Glass shelf / Glasablage
- 60/15

12,48 PT *

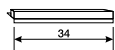

- Svetilka Verna za ogledalo / Svjetiljka Verna za ogledalo / Verna lamp for mirror / Leuchte Verna für Spiegel
- 40/100/2

48,73 PT *



- Svetilka Libeccio za ogledalo / Svjetiljka Libeccio za ogledalo / Libeccio lamp for mirror / Leuchte Libeccio für Spiegel
- 80/80/2

80,88 PT *



Ogledalo

- Ogledalo / Mirror / Spiegel
- 40/100/2

32,40PT *

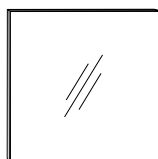

Ogledalo

- Ogledalo / Mirror / Spiegel
- 80/80/2

42,69 PT *

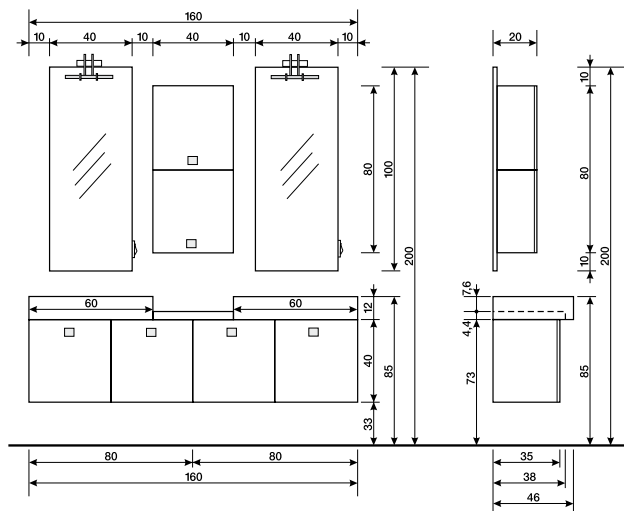

QUADRA



Vrata: oplasčena vlaknenea plošča (MDF) v visokem sijaju: bela
Obod: oplemenitena iverna plošča: bela sijaj

Vrata: obložena vlaknatica (MDF) u visokom sjaju: bijela
Obod: oplemenjena iverica: bijela sjaj



Door: foiled fibreboard (MDF) with high-gloss finish: white

Body: laminated particle board: white gloss

Front: Faserplatte (MDF) Hochglanz foliert: Weiß

Korpus: Kunststoffoberfläche: Weiß Glanz

QUADRA



Vrata: oplasčena vlaknenea plošča (MDF) v visokem sijaju: bela

Obod: oplemenitena iverna plošča: bela sijaj

Vrata: obložena vlaknatica (MDF) u visokome sjaju: bijela

Obod: oplemenjena iverica: bijela sjaj

Door: foiled fibreboard (MDF) with high-gloss finish: white

Body: laminated particle board: white gloss

Front: Faserplatte (MDF) Hochglanz foliert: Weiß

Korpus: Kunststoffoberfläche: Weiß Glanz



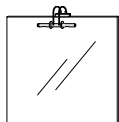

Ogledalo 60x60 cm s svetilko
Ogledalo 60x60 cm sa svjetiljkom
Mirror 60x60 cm with light fitting
Spiegel 60x60 cm mit Leuchte
101,78 PT *

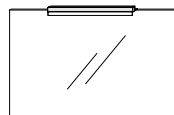

Ogledalo 90x60 cm s svetilko
Ogledalo 90x60 cm sa svjetiljkom
Mirror 90x60 cm with light fitting
Spiegel 90x60 cm mit Leuchte
78,18 PT *

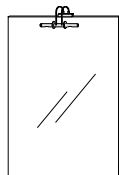

Ogledalo 60x90 cm s svetilko
Ogledalo 60x90 cm sa svjetiljkom
Mirror 60x90 cm with light fitting
Spiegel 60x90 cm mit Leuchte
110,38 PT *

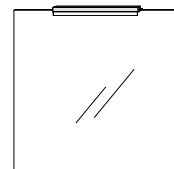

Ogledalo 90x90 cm s svetilko
Ogledalo 90x90 cm sa svjetiljkom
Mirror 90x90 cm with light fitting
Spiegel 90x90 cm mit Leuchte
84,00 PT *

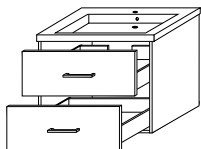

BKG 60.11
Umivalnik 60 cm
Umivaonik 60 cm
Basin 60 cm
Waschbecken 60 cm
• 60/5/46
Element pod umivalnikom 60 cm
Element ispod umivaonika 60 cm
Vanity cabinet 60 cm
Waschbeckenunterschrank 60 cm
• 60/50/45
243,47 PT *

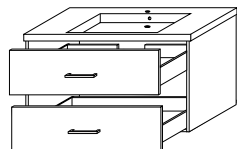

BKG 90.05
Umivalnik 90 cm
Umivaonik 90 cm
Basin 90 cm
Waschbecken 90 cm
• 90/5/46
Element pod umivalnikom 90 cm
Element ispod umivaonika 90 cm
Vanity cabinet 90 cm
Waschbeckenunterschrank 90 cm
• 90/50/45
285,46 PT *

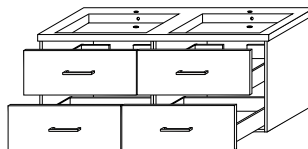

BKG 120.06
Umivalnik 120 cm
Umivaonik 120 cm
Basin 120 cm
Waschbecken 120 cm
• 120/5/46
Element pod umivalnikom 120 cm
Element ispod umivaonika 120 cm
Vanity cabinet 120 cm
Waschbeckenunterschrank 120 cm
• 120/50/45
439,75 PT *

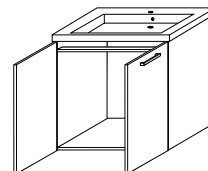

BKG 60.12
Umivalnik 60 cm
Umivaonik 60 cm
Basin 60 cm
Waschbecken 60 cm
• 60/5/46
Element pod umivalniko 60 cm
Element ispod umivaonika 60 cm
Vanity cabinet 60 cm
Waschbeckenunterschrank 60 cm
• 60/60/45
182,93 PT *

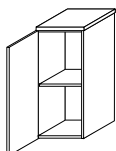

BKG 30.21 L,D
Spodnji element s pokrivno ploščo L,D
Donji element s pokrivnom pločom L,D
Base cabinet with functional top L,R
Unterschrank mit Deckplatte L,R
• 30,2/63/35,5
88,86 PT *

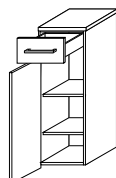

BKG 30.20 L,D
Spodnji element s pokrivno ploščo L,D
Donji element s pokrivnom pločom L,D
Base cabinet with functional top L,R
Unterschrank mit Deckplatte L,R
• 30,2/92,8/35,5
133,78 PT *

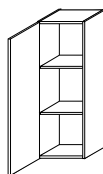

C 30.09 L,D
Viseći element L,D
Viseći element L,D
Wall cabinet L,R
Wandschrank L,R
• 30/90/20
64,12 PT *

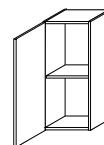

B 30.01 L,D
Viseći element L,D
Viseći element L,D
Wall cabinet L,R
Wandschrank L,R
• 30/60/20
50,45 PT *

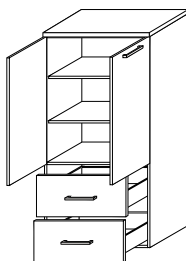

BKG 60.29
Visoka omara s pokrivno ploščo
Visoki ormar s pokrovnom pločom
Tall cabinet with functional top
Highboard mit Abdeckplatte
• 60,3/127,8/36
259,75 PT *

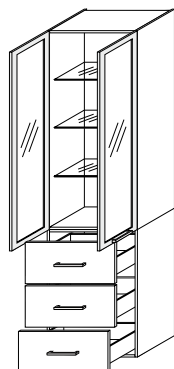

BKG 50.05
Visoka omara
Visoki ormar
Tall cabine
Hochschrank
• 50/195/35
413,71 PT *

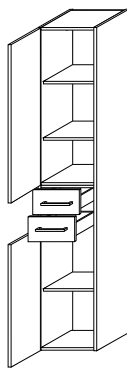

E 30.12 L,D
Visoka omara L,D
Visoki ormar L,D
Tall cabinet L,R
Hochschrank L,R
• 30/180/35
204,74 PT *

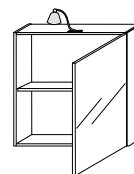

F 60.11 D,L
Viseći element z ogledalom in svetilko D,L
Viseći element s ogledalom i svjetiljkom D,L
Wall-mounted mirror cabinet with light fitting R,L
Spiegelschrank mit Leuchte R,L
• 60/60/20
115,55 PT *



Steklena polica
Staklena polica
Glass shelf
Glasablage
• 60/15
12,48 PT *



Steklena polica
Staklena polica
Glass shelf
Glasablage
• 90/15
14,55 PT *



PREGLED PONUDBE

Umivalniki, ogledala, omarice z ogledali, svetilke in ročaji.

PREDGLED PONUDE

Umivaonici, ogledala, ormariči s ogledalima, svjetiljke i ručke.



OUR OFFER

Basins, mirrors, mirror cabinets, lamps and handles.

PRÜFUNG DES ANGEBOTS

Waschbecken, Spiegel, Spiegelschränke, Leuchten und Griffe.

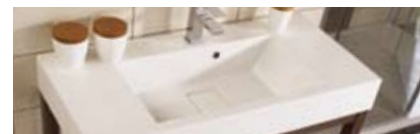

Umivalniki
Umivaonici
Basins
Waschbecken 122



Ogledala
Ogledala
Mirrors
Spiegel 131



Omarice z ogledali
Ormariči s ogledalima
Mirror cabinets
Spiegelschränke 133

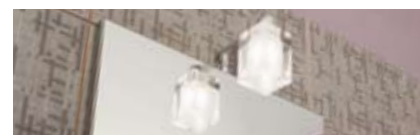

Svetilke
Svjetiljke
Lamps
Leuchten 134

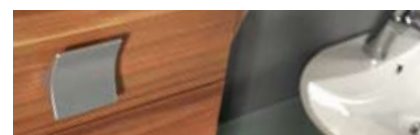

Ročaji
Ručke
Handles
Griffe 135

Umivalniki / Umivaonici / Basins / Waschbecken

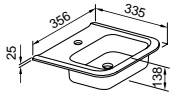
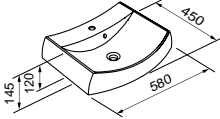
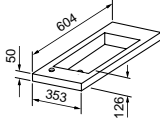
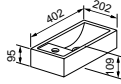
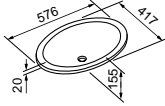
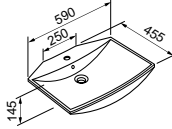
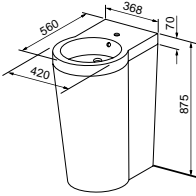
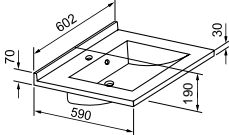
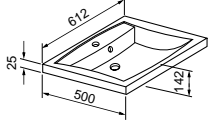
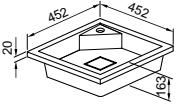
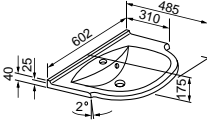
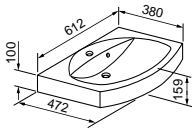
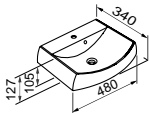
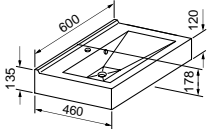
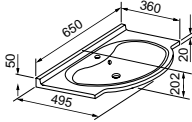
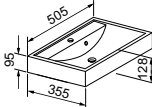
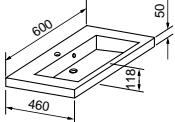
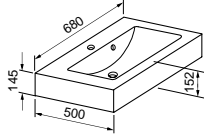
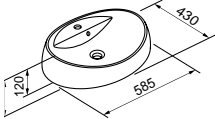
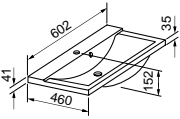
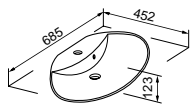
<p>UM 35.183 Jazz small</p> 	<p>UM 58.99</p> 	<p>UM 60.120 Slim</p> <p>* (2)</p> 
<p>UM 40.91</p> 	<p>UM 58.187 Romeo</p> 	<p>UM 60.169 Orion</p> 
<p>UM 42.185 Julija</p> 	<p>UM 60.52</p> 	<p>UM 61.110</p> 
<p>UM 45.177 Kuba</p> 	<p>UM 60.57 Compact</p> 	<p>UM 61.132</p> 
<p>UM 48.106</p> 	<p>UM 60.67, UM 60.82 Tango</p> 	<p>UM 65.76</p> 
<p>UM 51.155</p> 	<p>UM 60.95 Quadra</p> 	<p>UM 68.66, UM 68.80</p> 
<p>UM 58.98</p> 	<p>UM 60.181 Avon</p> <p>* (2)</p> 	<p>UM 69.136 Vega</p> 

* Možnost samostojne pritrditve umivalnika na steno z nosilcem za umivalnike. Mogućnost samostalnoga pričvršćivanja umivaonika na zid s nosačem umivaonika.

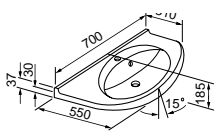
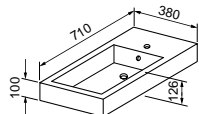
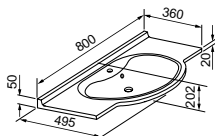
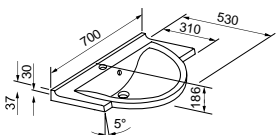
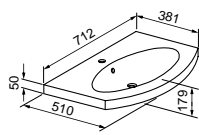
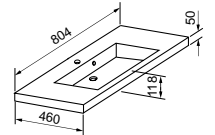
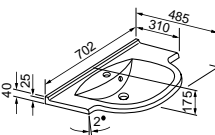
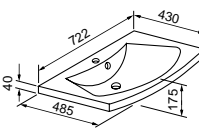
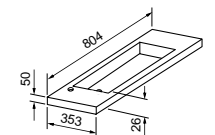
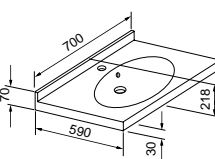
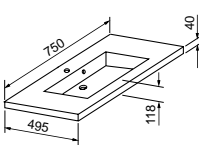
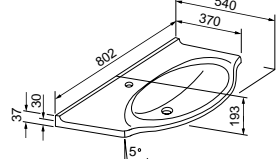
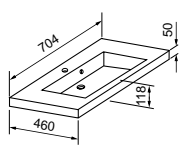
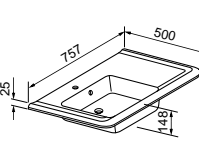
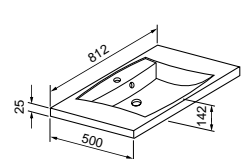
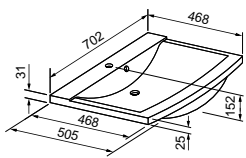
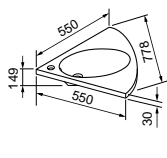
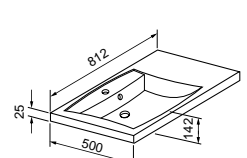
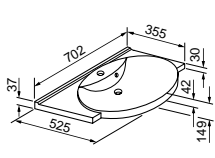
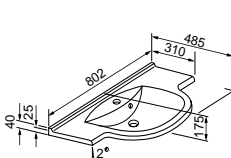
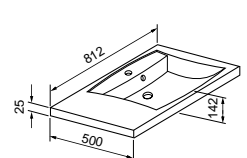
<p>UM 70.08 Jana</p> 	<p>UM 71.149</p> 	<p>UM 80.76</p> 
<p>UM 70.16</p> 	<p>UM 71.165</p> 	<p>UM 80.95</p> 
<p>UM 70.57 Compact</p> 	<p>UM 72.114</p> 	<p>UM 80.120 Slim</p> <p>* (2)</p> 
<p>UM 70.88 Natura</p>  <p>SOLIGOR</p>	<p>UM 75.78</p> 	<p>UM 80.161</p> 
<p>UM 70.95</p> 	<p>UM 75.145 L</p> 	<p>UM 81.110</p> 
<p>UM 70.118 Oasis</p> 	<p>UM 78.144 Corner</p> 	<p>UM 81.110 L</p> 
<p>UM 70.140 Standard</p> <p>* (2)</p> 	<p>UM 80.57 Compact</p> 	<p>UM 81.110 D</p> 

* Option of independent wall-mounted basin fitted onto a bracket. Das Waschbecken kann mittels einer Konsole eigenständig an der Wand befestigt werden.

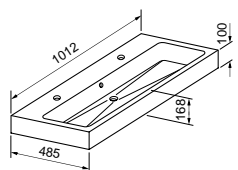
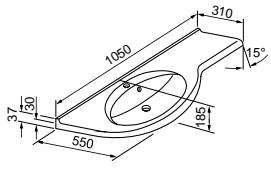
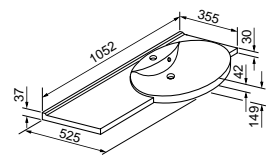
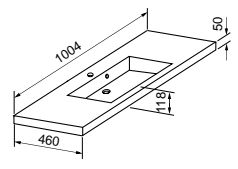
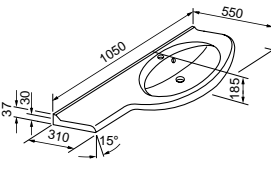
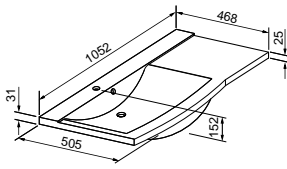
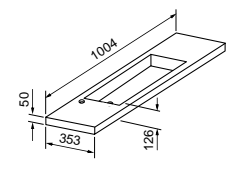
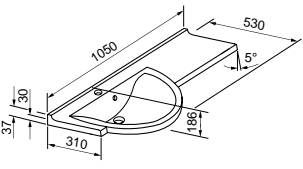
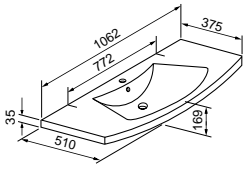
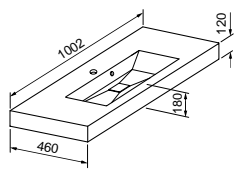
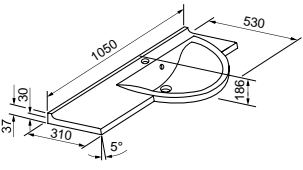
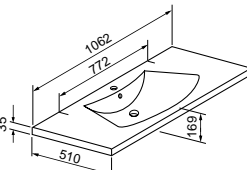
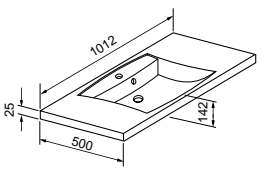
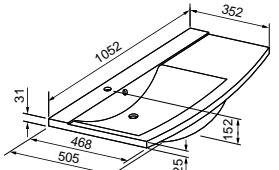
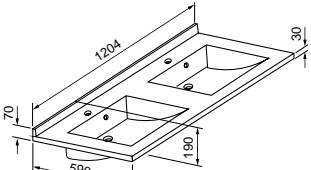
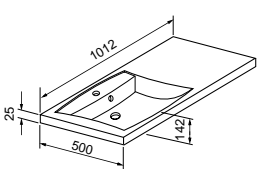
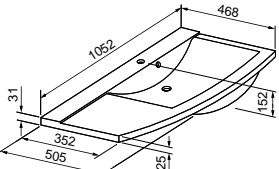
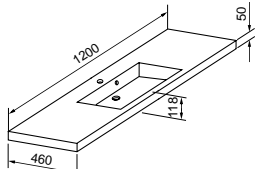
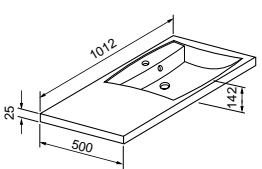
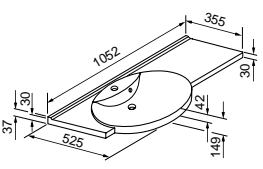
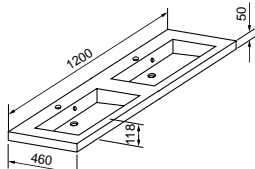
<p>UM 100.69</p> 	<p>UM 105.23 L Ergo</p> 	<p>UM 105.140 D Standard</p> <p>* (2)</p> 
<p>UM 100.95</p> 	<p>UM 105.23 D Ergo</p> 	<p>UM 105.175 L</p> 
<p>UM 100.120 Slim</p> <p>* (2)</p> 	<p>UM 105.28 L</p> 	<p>UM 106.128</p> 
<p>UM 100.179 Markiz, Monet</p> <p>* (2)</p> 	<p>UM 105.28 D</p> 	<p>UM 106.130</p> 
<p>UM 101.110</p> 	<p>UM 105.118 L Oasis</p> 	<p>UM 120.52</p> 
<p>UM 101.110 L</p> 	<p>UM 105.118 D Oasis</p> 	<p>UM 120.95</p> 
<p>UM 101.110 D</p> 	<p>UM 105.140 L Standard</p> <p>* (2)</p> 	<p>UM 120.96 Quadra</p> 

* Option of independent wall-mounted basin fitted onto a bracket. Das Waschbecken kann mittels einer Konsole eigenständig an der Wand befestigt werden.

Umivalniki / Umivaonici / Basins / Waschbecken

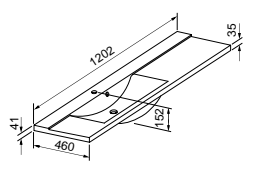
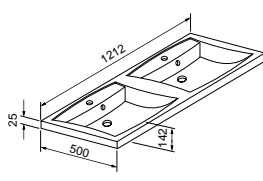
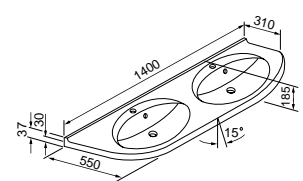
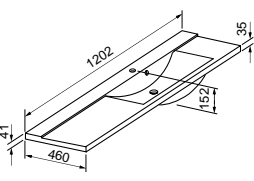
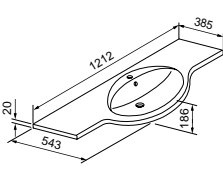
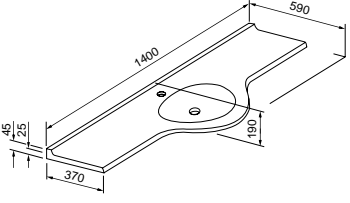
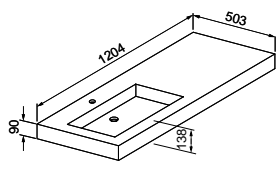
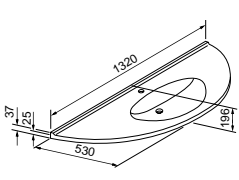
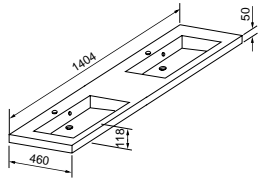
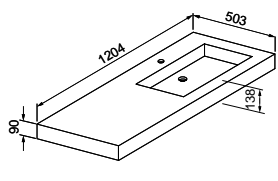
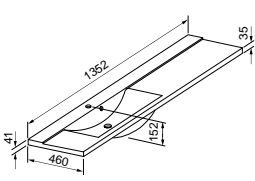
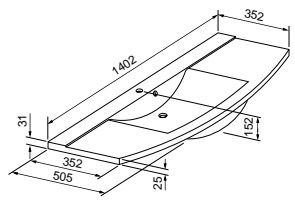
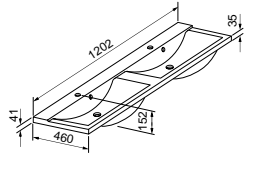
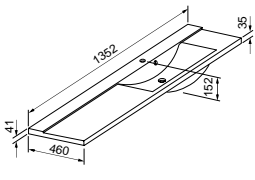
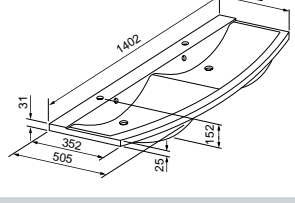
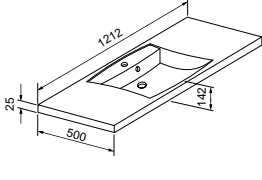
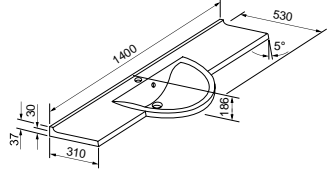
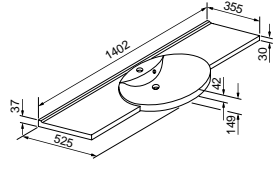
<p>UM 120.104 L</p> <p>Avon</p> <p>* (2)</p> 	<p>UM 121.111</p> 	<p>UM 140.44</p> 
<p>UM 120.104 D</p> <p>Avon</p> <p>* (2)</p> 	<p>UM 121.126</p> 	<p>UM 140.81</p> 
<p>UM 120.153 L</p> 	<p>UM 132.122</p> 	<p>UM 140.96</p> 
<p>UM 120.153 D</p> 	<p>UM 135.104 L</p> <p>Avon</p> <p>* (3)</p> 	<p>UM 140.118</p> <p>Oasis</p> 
<p>UM 120.182</p> <p>Avon</p> <p>* (3)</p> 	<p>UM 135.104 D</p> <p>Avon</p> <p>* (3)</p> 	<p>UM 140.119</p> <p>Oasis</p> 
<p>UM 121.110</p> 	<p>UM 140.16</p> 	<p>UM 140.140</p> <p>Standard</p> <p>* (4)</p> 

* Možnost samostojne pritrditve umivalnika na steno z nosilcem za umivalnike. Mogućnost samostalnoga pričvršćivanja umivaonika na zid s nosačem umivaonika.

Umivalniki po meri / Umivaonici po mjeri / Custom made basins / Waschbecken nach Maß

<p>UM 79.83</p>	<p>UM 99.159</p>	<p>UM 129.109 Avon</p> <p>* (3)</p>
<p>UM 79.142 Trendline</p> <p>* (2)</p>	<p>UM 109.109 Avon</p>	<p>UM 139.81</p>
<p>UM 79.159</p>	<p>UM 119.81</p>	<p>UM 139.83</p>
<p>UM 99.81</p>	<p>UM 119.83</p>	<p>UM 139.84</p>
<p>UM 99.83</p>	<p>UM 119.142 Trendline</p> <p>* (3)</p>	<p>UM 139.142 Trendline</p> <p>* (4)</p>
<p>UM 99.142 Trendline</p> <p>* (2)</p>	<p>UM 119.157</p>	<p>UM 139.157</p>
<p>UM 99.157</p>	<p>UM 119.159</p>	<p>UM 139.159</p>

* Možnost samostojne pritrditve umivalnika na steno z nosilcem za umivalnike. Mogućnost samostalnoga pričvršćivanja umivaonika na zid s nosačem umivaonika.

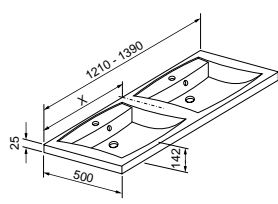
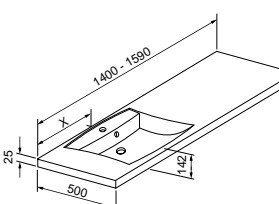
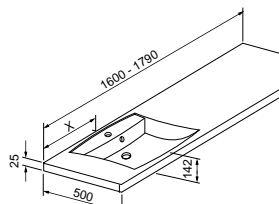
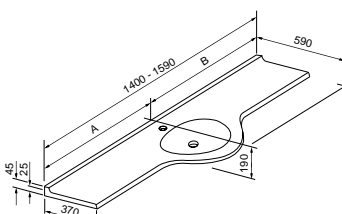
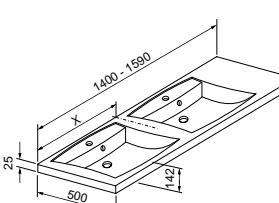
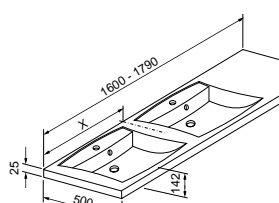
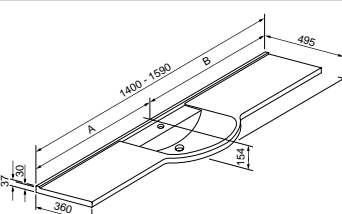
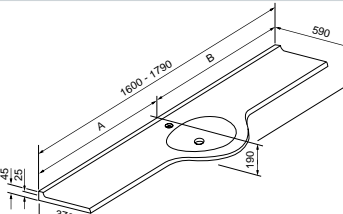
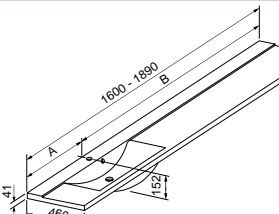
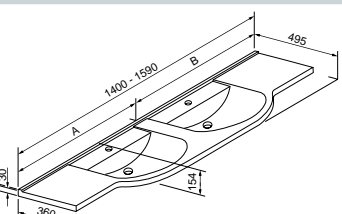
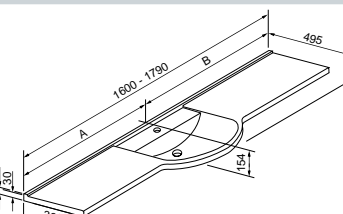
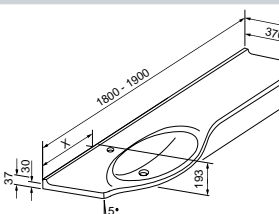
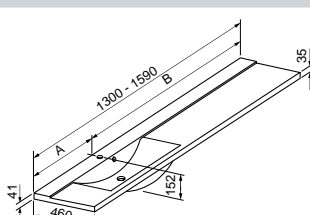
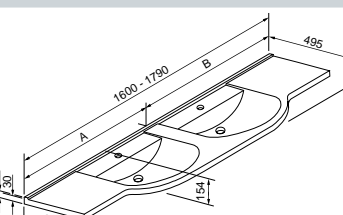
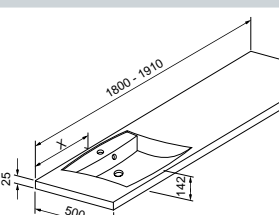
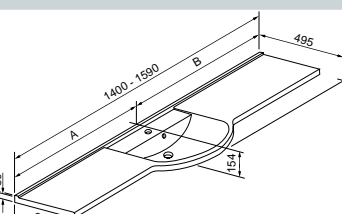
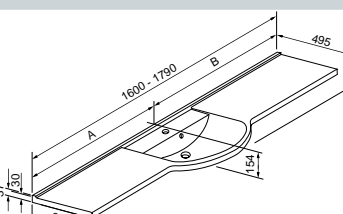
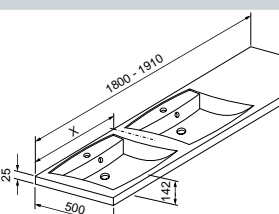
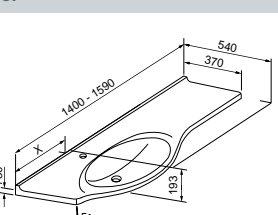
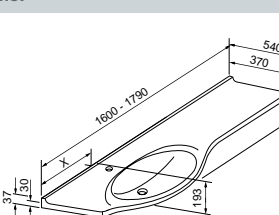
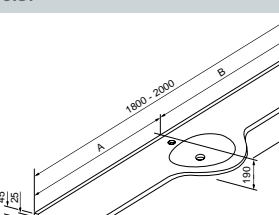
<p>UM 139.160</p> 	<p>UM 159.159</p> 	<p>UM 179.159</p> 
<p>UM 159.81</p> 	<p>UM 159.160</p> 	<p>UM 179.160</p> 
<p>UM 159.83</p> 	<p>UM 179.81</p> 	<p>UM 189.109 Avon</p> <p>* (4)</p> 
<p>UM 159.84</p> 	<p>UM 179.83</p> 	<p>UM 190.157</p> 
<p>UM 159.109 Avon</p> <p>* (4)</p> 	<p>UM 179.84</p> 	<p>UM 191.159</p> 
<p>UM 159.142 Trendline</p> <p>* (4)</p> 	<p>UM 179.142 Trendline</p> <p>* (4)</p> 	<p>UM 191.160</p> 
<p>UM 159.157</p> 	<p>UM 179.157</p> 	<p>UM 200.81</p> 

* Option of independent wall-mounted basin fitted onto a bracket. Das Waschbecken kann mittels einer Konsole eigenständig an der Wand befestigt werden.

Umivalniki po meri / Umivaonici po mjeri / Custom made basins / Waschbecken nach Maß

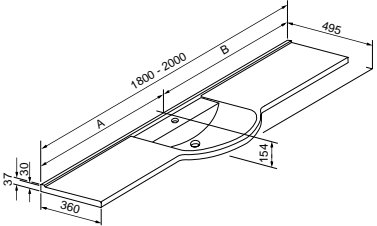
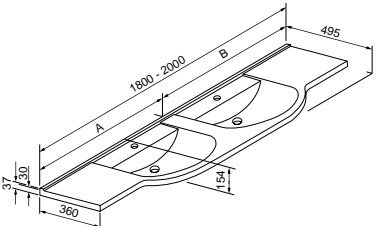
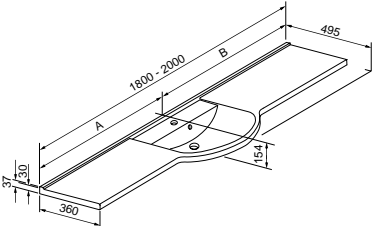
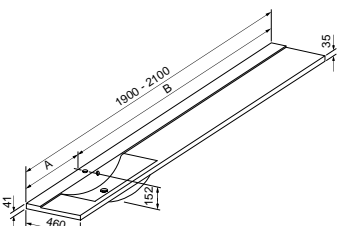
UM 200.83	UM 200.84	UM 200.142	Trendline
		 <p>* (4)</p>	
UM 210.109	Avon		
 <p>* (4)</p>			

Nosilec umivalnika in obešalo za brisače / Nosač umivaonika i držač ručnika Basin bracket and towel rail / Waschbeckenträger und Handtuchhalter

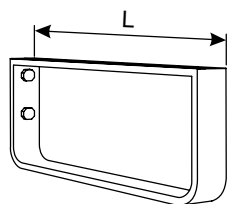





NUM 345
L = 34,5 cm
42,75 PT *

NUM 452
L = 45,2 cm
44,50 PT *

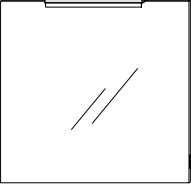
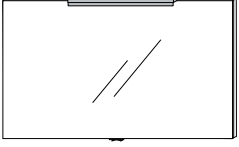
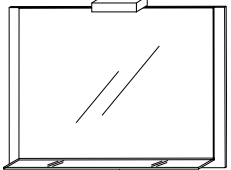

Ogledala / Ogledala / Mirrors / Spiegel

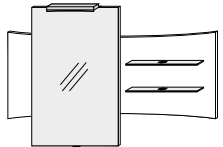
SKG 35.03 (35x75x2) Jazz small svetilka / svjetiljka / lamp / Leuchte: Clix 	F 35.97 (35x87x19) Standard Police v barvah programa Standard Police u bojama programa Standard Shelves in colours of the Standard programme palette Ablagen in Farben des Standard Programms 	F 35.35 (35x116,3x19) Standard Police v barvah programa Standard Police u bojama programa Standard Shelves in colours of the Standard programme palette Ablagen in Farben des Standard Programms 
Ogledalo (40x100x2) Kuba svetilka / svjetiljka / lamp / Leuchte: Joy 	Ogledalo (40x100x2) Monet, Romeo, Julija svetilka / svjetiljka / lamp / Leuchte: Plano A 	Ogledalo (40x100x2) Tango svetilka / svjetiljka / lamp / Leuchte: Libeccio 
Ogledalo (50x80x2) Vega svetilka / svjetiljka / lamp / Leuchte: Verna 34 	Ogledalo (60x60x2) Quadra svetilka / svjetiljka / lamp / Leuchte: Libeccio 	Ogledalo (60x60x2) Orion svetilka / svjetiljka / lamp / Leuchte: Cali mat 
SKG 60.03 (60x75x18,3) Avon svetilka / svjetiljka / lamp / Leuchte: Brick R Polica v barvah programa Avon Polica u bojama programa Avon Shelf in colours of the Avon programme palette Ablage in Farben des Avon Programms 	Ogledalo (60x80x2) Slim svetilka / svjetiljka / lamp / Leuchte: Verna 55 	Ogledalo (60x90x2) Quadra svetilka / svjetiljka / lamp / Leuchte: Libeccio 
Ogledalo (70x70x2) Jana 	Ogledalo (70x70x2) Oasis svetilka / svjetiljka / lamp / Leuchte: Lineon 	SKG 75.03 (75x75x2) Jazz svetilka / svjetiljka / lamp / Leuchte: Brick R Panel v barvah programa Jazz Panel u bojama programa Jazz Panel in colours of the Jazz programme palette Paneel in Farben des Jazz Programms 
Ogledalo (80x60x2) Slim svetilka / svjetiljka / lamp / Leuchte: Verna 55 	Ogledalo (80x80x2) Romeo svetilka / svjetiljka / lamp / Leuchte: Plano A 	Ogledalo (80x80x2) Tango svetilka / svjetiljka / lamp / Leuchte: Verna 55 
F 80.16 (80x80x3,5) Vega svetilka / svjetiljka / lamp / Leuchte: Verna 34 Panel v dekorju slive Panel u dekoru šljive Panel in plum finish Paneel Holzdekor Zwetschke 	Ogledalo (90x60x2) Quadra svetilka / svjetiljka / lamp / Leuchte: Verna 55 	SKG 90.03 (90x75x18,3) Avon svetilka / svjetiljka / lamp / Leuchte: Brick R Polica v barvah programa Avon Polica u bojama programa Avon Shelf in colours of the Avon programme palette Ablage in Farben des Avon Programms 

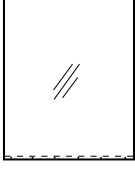
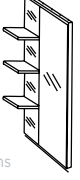



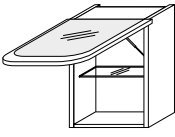

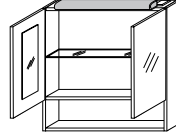
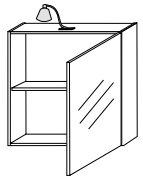
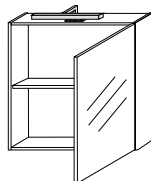
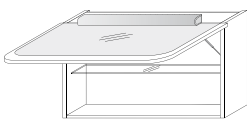
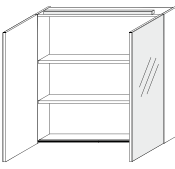
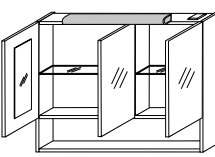
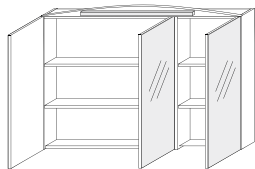
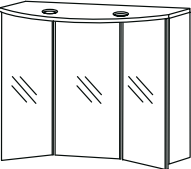
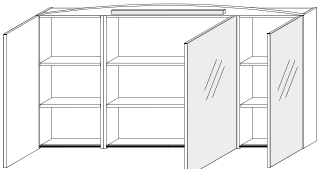













Ogledala / Ogledala / Mirrors / Spiegel

<p>Ogledalo (90x90x2) Quadra</p> <p>svetilka / svjetiljka / lamp / Leuchte: Verna 55</p> 	<p>Ogledalo (100x60x2) Slim</p> <p>svetilka / svjetiljka / lamp / Leuchte: Verna 55</p> 
<p>F 100.14 (100x70x13) Markiz</p> <p>svetilka / svjetiljka / lamp / Leuchte: Plano A</p> <p>Panel v barvah programa Markiz Panel u bojama programa Markiz Panel in colours of the Markiz programme palette Panneel in Farben des Markiz Programms</p> 	<p>Ogledalo (105x70x2) Oasis</p> <p>svetilka / svjetiljka / lamp / Leuchte: Lineon</p> 
<p>F 120.16 L,D (120x80x13) Vega</p> <p>svetilka / svjetiljka / lamp / Leuchte: Verna 34</p> <p>Panel v dekorju slive Panel u dekoru šljive Panel in plum finish Panneel Holzdekor Zwetschke</p> 	<p>Ogledalo (140x70x2) Oasis</p> <p>svetilka / svjetiljka / lamp / Leuchte: Lineon</p> 
<p>Ogledalo Standard</p> <ul style="list-style-type: none"> • 70/90/2 • 70/116,3/2 • 90/90/2 • 90/116,3/2 • 105/90/2 • 105/116,3/2 	<p>F 70.31 L,D (70x116,3x19) Standard</p> <p>Police v barvah programa Standard Police u bojama programa Standard Shelves in colours of the Standard programme palette Ablagen in Farben des Standard Programms</p> 





















Omarice z ogledali / Ormarići s ogledalima / Mirror cabinets / Spiegelschränke

<p>F 35.03 (35x40x16)</p> <p>Jazz</p> 	<p>F 42.01 (42,4x70x31,9)</p> <p>Corner</p> 	<p>F 60.02 (60x75x20)</p> <p>Avon</p> <p>svetilka / svjetiljka / lamp / Leuchte: Brick R</p> 
<p>F 60.11 L,D (60x60x20)</p> <p>Quadra</p> <p>svetilka / svjetiljka / lamp / Leuchte: Art. 81</p> 	<p>F 60.11 L,D (60x60x20)</p> <p>Orion</p> <p>svetilka / svjetiljka / lamp / Leuchte: Cali mat</p> 	<p>F 70.13 (75x40x16)</p> <p>Jazz</p> <p>svetilka / svjetiljka / lamp / Leuchte: Brick R</p> 
<p>F 70.40 (70x70x18,4)</p> <p>Oasis</p> <p>svetilka / svjetiljka / lamp / Leuchte: Lineon</p> 	<p>F 90.22 (90x75x20)</p> <p>Avon</p> <p>svetilka / svjetiljka / lamp / Leuchte: Brick R</p> 	<p>F 105.40 L,D (105x70x18,4)</p> <p>Oasis</p> <p>svetilka / svjetiljka / lamp / Leuchte: Lineon</p> 
<p>F 105.50 (105x90x23)</p> <p>Standard</p> 	<p>F 140.04 (140x70x18,4)</p> <p>Oasis</p> <p>svetilka / svjetiljka / lamp / Leuchte: Lineon</p> 	

Svetilke / Sjetiljke / Lamps / Leuchten

<p>Art. 81</p> <p>Quadra</p>  <p>752130</p>	<p>Brick R</p>  <p>754432 - SKG 60.03, SKG 90.03, SKG 75.03 754433 - F 60.02, F 90.22, F 70.13</p>	<p>Jazz, Avon</p> <p>Cali</p>  <p>799571 - BKG 60.33, BKG 90.20 L.D, BKG 150.09 799572 - BKG 60.34, BKG 90.19 L.D, BKG 150.10</p> <p>Orion</p>
<p>Clix</p> <p>Jazz small</p>  <p>754956</p>	<p>Joy</p> 	<p>Kuba</p> <p>Libeccio</p>  <p>432147</p> <p>Tango, Quadra</p>
<p>Lineon</p> <p>Oasis</p>  <p>756088 - F 70.40 755015 - F 105.40 L,D, F 140.04 755655 - OGLEDALA 70x70 cm, 105x70 cm, 140x70 cm</p>	<p>Miro Tondo</p> <p>Natura</p>  <p>752799 (svetilo) / 752800 (stikalo) / 744541 (komplet)</p>	<p>Plano A</p>  <p>Julija, Monet, Markiz, Romeo</p>
<p>Verna (340 mm)</p> <p>Vega</p>  <p>756740</p>	<p>Verna (550 mm)</p> <p>Quadra, Slim</p>  <p>477040</p>	<p>Andrea</p> 
<p>Eider</p> <p>Oasis, Jazz</p> 	<p>Eva</p> <p>Natura</p> 	<p>Moira</p> <p>Kuba</p> 
<p>Ruth</p> <p>Oasis, Avon</p> 	<p>Salma 1</p> <p>Monet, Jana, Tango, Quadra</p> 	<p>Salma 2</p> <p>Markiz, Romeo</p> 
<p>Thais</p> 	<p>Veronica</p> <p>Vega, Slim, Orion</p> 	

Ročaji / Ručke / Handles / Griffe

29.Cr (64 mm)	Standard, Ergo, Jana	33.Cr/sij (64 mm)	Catania	36.Cr (96 mm)	Standard
					
58.Zn/sij (64 mm)	Standard	63.Cr	Standard, Compact	65.Ni (96 mm)	Standard
					
70.Cr/mat (128 mm)	Standard	72.Cr	Standard	80.Cr (64 mm)	Standard
					
84.Cr/mat (96 mm)	Orion, Standard	89.Cr/mat (160 mm)	Quadra	90.Cr/mat	Avon
				 90.30 (146 mm) 90.45 (296 mm) 90.60 (446 mm) 90.90 (746 mm)	
92.Cr (96 mm)	Standard	93.Cr (32 mm)	Corner, Tango	94.Cr/sij (128 mm)	Natura
					
95.01 Al (224 mm)	Jazz	95.02 črn Al (224 mm)	Jazz karbon	99. Cr/mat (32 mm)	Vega
					
104.Cr (32 mm)	Standard	105.Ni (224 mm)	Slim, Monet	107.Ag patina (16 mm)	Romeo
					

Gorenje Notranja oprema d.o.o.

Program Kopalnice

Primorska 6/b

3325 Šoštanj

Slovenija

Tel: +386 3 898 53 10, Fax: +386 3 898 53 13

<http://www.gorenje-no.si>



Slike v katalogu se lahko razlikujejo od izdelkov v prodaji. Pridržujemo si pravico do spremembe programa.

Slike u katalogu mogu se razlikovati od proizvoda u prodaji. Pridržavamo pravo izmjene programa.

Pictures in the catalogue may differ from actual retail products. The manufacturer reserves the right to product lines changes.

Die Bilder im Katalog können sich von den Verkaufsprodukten unterscheiden. Änderungen vorbehalten!