



MASTERLINE
by Bisk

CATALOGUE / KATALOG

2018

TABLE OF CONTENTS SPIS TREŚCI

- 04 **Paper dispensers**
Podajniki na papier
- 06 **Automatic dryers**
Suszarki automatyczne
- 07 **Soap dispensers**
Dozowniki mydła
- 11 **Waste baskets**
Kosze na śmieci
- 11 **Exploataion materials**
Materiały eksploatacyjne
- 12 **Supplementary accessories**
Akcesoria uzupełniające
- 15 **PRO Handicap accessories**
Akcesoria PRO dla niepełnosprawnych
- 18 **Selected BISK bathroom accessories**
Wybór akcesoriów łazienkowych BISK





MASTERLINE by BISK is a brand dedicated to the institutional clients and is part of the BISK SA Group, a long-established Polish producer of bathroom accessories present on all major European markets. With the experience gathered over the years we came to the decision of launching this range of products, which through rigorous quality control and universal design perfectly fit into the nature of public space.

MASTERLINE

by Bisk

MASTERLINE by BISK to marka dedykowana klientom instytucjonalnym, wchodząca w skład portfolio Grupy BISK S.A., polskiego producenta akcesoriów łazienkowych, działającego na wszystkich najważniejszych rynkach europejskich. Zgromadzone przez lata doświadczenie Grupy zaowocowało stworzeniem gamy produktów, które poprzez rygorystyczną kontrolę jakości oraz uniwersalne wzornictwo doskonale wpisują się w charakter przestrzeni publicznej.



PAPER DISPENSERS PODAJNIKI NA PAPIER

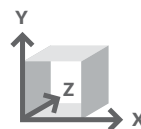

MASTERLINE
by Bisk



**NEW
2018**

PL-P4
ABS
black/czarny
X 294 Y 263 Z 148
paper towels
500 pcs, 25x23 cm
papier w listkach
500 szt., 25x23 cm

07235



**NEW
2018**

Jumbo-P4
ABS
black/czarny
X 258 Y 267 Z 117
for toilet rolls max Ø 23 cm
rolki papieru max Ø 23 cm

07236



PL-P2
ABS
silver matt/srebrny mat
X 294 Y 263 Z 148
paper towels
500 pcs, 25x23 cm
papier w listkach
500 szt., 25x23 cm

00398



Jumbo-P2
ABS
silver matt/srebrny mat
X 258 Y 267 Z 117
for toilet rolls max Ø 23 cm
rolki papieru max Ø 23 cm

00505



PL-P1
ABS
white/biały
X 294 Y 263 Z 148
paper towels
500 pcs, 25x23 cm
papier w listkach
500 szt., 25x23 cm

00344



Jumbo-P1
ABS
white/biały
X 258 Y 267 Z 117
for toilet rolls max Ø 23 cm
rolki papieru max Ø 23 cm

00399



PRP-1
PP
white/biały
X 270 Y 165 Z 150
paper rolls Ø14 cm
rolki papieru Ø14 cm
paper towels
250 pcs, 25x23 cm
papier w listkach
250 szt., 25x23 cm

03863



PU-P1
ABS
white/biały
X 150 Y 290 Z 140
for toilet rolls 2x Ø12 cm
rolki papieru 2x Ø12cm
paper towels 11,5x12,5 cm
papier w listkach 11,5x12,5 cm

04305



PAPER DISPENSERS PODAJNIKI NA PAPIER

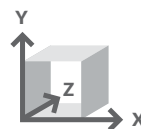

MASTERLINE
by Bisk



00342

PL-S1
stainless steel/stal nierdzewna
brushed/szczotkowana
X 284 Y 266 Z 100
paper towels
500 pcs, 25x23 cm
papier w listkach
500 szt., 25x23 cm



00343

Jumbo-S1
stainless steel/stal nierdzewna
brushed/szczotkowana
X 254 Y 262 Z 115
for toilet rolls max Ø 23 cm
rolki papieru max Ø 23 cm



01571

PL-S2
stainless steel/stal nierdzewna
chrome/chrom
X 284 Y 266 Z 100
paper towels
500 pcs, 25x23 cm
papier w listkach
500 szt., 25x23 cm



01570

Jumbo-S2
stainless steel/stal nierdzewna
chrome/chrom
X 254 Y 262 Z 115
for toilet rolls max Ø 23 cm
rolki papieru max Ø 23 cm



AUTOMATIC DRYERS SUSZARKI AUTOMATYCZNE

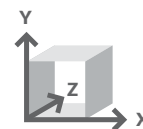

MASTERLINE
by Bisk



01801

SRM-S1
stainless steel/stal nierdzewna
brushed/szczotkowana
X 260 Y 235 Z 145
2300W, 78dB

CE



01574

SR-P2
ABS
silver matt/srebrny mat
X 240 Y 300 Z 145
1200W, 63dB

CE



01569

SR-S2
stainless steel/stal nierdzewna
chrome/chrom
X 220 Y 280 Z 160
1650W, 63dB

CE



00194

SR-P1
ABS
white/biała
X 240 Y 300 Z 145
1200W, 63dB

CE



00195

SR-S1
stainless steel/stal nierdzewna
brushed/szczotkowana
X 220 Y 280 Z 160
1650W, 63dB

CE



00241

SU-P1
ABS
white/biały
X 180 Y 280 Z 125
800W, 67dB

CE



01802

SH-P1
ABS
white/biały
X 90 Y 220 Z 145
1200W, 75dB

CE



SOAP DISPENSERS DOZOWNIKI MYDŁA

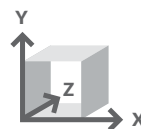

also for disinfection liquid
także do: płyn dezynfekujący

MASTERLINE
by Bisk



02280

L1 / ABS
white/biały
X 110 Y 275 Z 100
1000 ml



02281

L2 / ABS
silver matt/srebrny mat
X 110 Y 275 Z 100
1000 ml



**NEW
2018**

07238

L4/ABS
black/czarny
X 110 Y 275 Z 100
1000 ml



02275

K1/ABS
white/biały
X 90 Y 208 Z 100
500 ml



02276

K2/ABS
silver matt/srebrny mat
X 90 Y 208 Z 100
500 ml



**NEW
2018**

07237

K4/ABS
black/czarny
X 90 Y 208 Z 100
500 ml



03558

ABS
white/biały
X 97 Y 210 Z 104
500 ml



02923

P1/ABS
white/biały
X 98 Y 210 Z 115
750 ml



03133

P2/ABS
silver matt/srebrny mat
X 98 Y 210 Z 115
750 ml



**NEW
2018**

02280

L1 / ABS
black/czarny
X 98 Y 210 Z 115
750 ml





SOAP DISPENSERS DOZOWNIKI MYDŁA

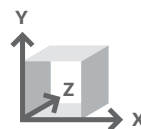

also for disinfection liquid
także do: płyn dezynfekujący

MASTERLINE by Bisk



04957

D1
stainless steel/stal nierdzewna
brushed/szczotkowana
X 97 Y 295 Z 105
1000 ml



05880

D2
stainless steel/stal nierdzewna
chrome/chrom
X 97 Y 295 Z 105
1000 ml



04959

DP1
stainless steel/stal nierdzewna
brushed/szczotkowana
X 97 Y 295 Z 105
1000 ml



06389

DM1
stainless steel/stal nierdzewna
brushed/szczotkowana
X 100 Y 230 Z 105
500 ml



06390

DM2
stainless steel/stal nierdzewna
chrome/chrom
X 100 Y 230 Z 105
500 ml



06391

DP-M1
stainless steel/stal nierdzewna
brushed/szczotkowana
X 100 Y 230 Z 105
500 ml



01416

stainless steel/stal nierdzewna
chrome/chrom
X 125 Y 202 Z 117
1000 ml



01417

stainless steel/stal nierdzewna
brushed/szczotkowana
X 125 Y 202 Z 117
1000 ml



01415

stainless steel/stal nierdzewna
chrome/chrom
X 98 Y 153 Z 105
500 ml



04084

stainless steel/stal nierdzewna
brushed/szczotkowana
X 103 Y 150 Z 105
500 ml

SOAP DISPENSERS DOZOWNIKI MYDŁA



also for disinfection liquid
także do: płyn dezynfekujący

MASTERLINE
by Bisk

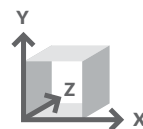

no-touch system
bezdotykowy



▶ automatic

05903

AK1 / ABS
white/biały
X 95 Y 217 Z 92
500 ml



▶ automatic

05904

AK2 / ABS
silver matt/srebrny mat
X 95 Y 217 Z 92
500 ml



▶ automatic

05905

AK3 / ABS
chrome/chrom
X 95 Y 217 Z 92
500 ml



▶ automatic

00588

ABS
white/biały
X 110 Y 220 Z 100
500 ml



▶ automatic

00589

ABS
silver matt/srebrny mat
X 110 Y 220 Z 100
500 ml



▶ automatic

06672

AS1 / stainless steel / stal nierdzewna / ABS
chrome/chrom
X 75 Y 185 Z 110
225 ml





SOAP DISPENSERS DOZOWNIKI MYDŁA

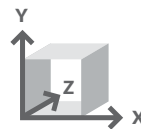

MASTERLINE
by Bisk



72027

ABS
white/biały
X 80 Y 195 Z 85
350 ml



72067

ABS
silver matt/srebrny mat
X 80 Y 195 Z 85
350 ml



72075

ABS
chrome/chrom
X 80 Y 195 Z 85
350 ml



00174

ABS
white/biały
X 138 Y 250 Z 80
2x400 ml



00175

ABS
chrome/chrom
X 138 Y 250 Z 80
2x400 ml



00173

ABS
chrome/chrom
X 84 Y 250 Z 80
400 ml



00172

ABS
white/biały
X 84 Y 250 Z 80
400 ml



07402

A1 / ABS
white/biały
X 98 Y 157 Z 85
500 ml



07517

A2 / ABS
silver matt/srebrny mat
X 98 Y 157 Z 85
500 ml



07600

A3 / ABS
chrome/chrom
X 98 Y 157 Z 85
500 ml



07802

C / ABS
white/biały
X 113 Y 190 Z 110
1000 ml



04760

BL1 / solid brass / mosiądz
brushed nickel / nikiel szczotkowany

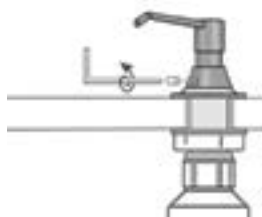

04759

BL2 / solid brass / mosiądz
chrome / chrom
X 180 Y 448 Z 90
1000 ml



07702

B / ABS
white/biały
X 81 Y 280 Z 105
1000 ml

WASTE BASKETS KOSZE NA ŚMIECI

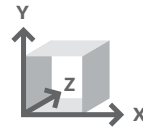

STAINLESS STEEL / STAL NIERDZEWNA

MASTERLINE
by Bisk

CHROME/CHROM



00057 3l

X 165 Y 255 Z 225

00283 5l

X 205 Y 280 Z 260

00056 7l

X 205 Y 315 Z 260

00430 12l

X 250 Y 375 Z 300

00060 20l

X 295 Y 440 Z 335

BRUSHED/SZCZOTKOWANA



00125 3l

X 165 Y 255 Z 225

03275 5l

X 205 Y 280 Z 260

00431 12l

X 250 Y 375 Z 300

01017 20l

X 295 Y 440 Z 335



00122 6l

chrome/chrom
X 205 Y 295 Z 250

04045 >



04045

lid/pokrywa kosza
X 425 Y 25 Z 195

00390 >

00390 35l

brushed/szczotkowana
X 420 Y 490 Z 195

▲ wall mounted / mocowany do ściany

POLIPROPYLENE/POLIPROPYLEN



91927 10l

white/biały
X 240 Y 410 Z 240



93002 15l

white/biały
X 275 Y 500 Z 275



93902 8l

white/biały
X 250 Y 370 Z 230



90302 5l

white/biały
X 200 Y 300 Z 200

EXPLOATATION MATERIALS MATERIAŁY EKSPLOATACYJNE



03353

MINI - Ø 14 cm
length/długość - 60 m



03354

MINI - Ø 14 cm
length/długość - 65 m



03355

JUMBO - Ø 18,5 cm
length/długość - 120 m



05890

ZZ
size/rozmiar: 25x23 cm



03158 5l

soft foam soap
mydło w pianie



02795 5l

liquid soap
mydło w płynie



02796 1l

liquid soap
mydło w płynie

SUPPLEMENTARY ACCESSORIES

AKCESORIA UZUPEŁNIAJĄCE

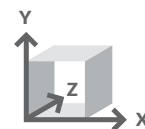

MASTERLINE
by Bisk



▲ wall mounted/mocowana do ściany

04456

SW-1/stainless steel/stal nierdzewna
brushed/szczotkowana
X 95 Y 406 Z 100



▲ wall mounted/mocowana do ściany

05923

SW-2/stainless steel/stal nierdzewna
chrome/chrom
X 95 Y 406 Z 100



00176

stainless steel/stal nierdzewna
chrome/chrom
X 100 Y 370 Z 100



00234

stainless steel/stal nierdzewna
brushed/szczotkowana
X 100 Y 370 Z 100



▲ wall mounted/mocowana do ściany

05924

SN-1/stainless steel/stal nierdzewna
brushed/szczotkowana
X 85 Y 382 Z 94



▲ wall mounted/mocowana do ściany

05925

SN-2/stainless steel/stal nierdzewna
chrome/chrom
X 85 Y 382 Z 94



00119

stainless steel/stal nierdzewna
chrome/chrom
X 110 Y 375 Z 110



00121

stainless steel/stal nierdzewna
brushed/szczotkowana
X 110 Y 375 Z 110



▲ wall mounted/mocowana do ściany

01016

stainless steel/stal nierdzewna
brushed/szczotkowana
X 95 Y 380 Z 110



▲ wall mounted/mocowana do ściany

71429

stainless steel/stal nierdzewna
chrome/chrom
X 95 Y 380 Z 110



02722 PP

white/biały
X 120 Y 350 Z 120



93702 PP

white/biały
X 125 Y 355 Z 125



80502 PP

white/biały
X 160 Y 360 Z 160

BABY CHANGING TABLE / PRZEWIJAK DLA DZIECKA

Article available on request / Towar dostępny na zamówienie

06217

horizontal/poziom
X 872 Y 512 Z 513



06216

vertical/pion
X 560 Y 899 Z 903



SUPPLEMENTARY ACCESSORIES

AKCESORIA UZUPEŁNIAJĄCE

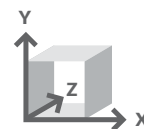

STAINLESS STEEL / STAL NIERDZEWNA

MASTERLINE
by Bisk



00046

chrome/chrom
X 135 Y 30 Z 90

00047

chrome/chrom
X 205 Y 30 Z 95



00045

chrome/chrom
X 235 Y 30 Z 170

00044

chrome/chrom
X 195 Y 30 Z 120



00048

chrome/chrom
X 235 Y 335 Z 170



02542

brushed nickel/szczotkowany nikiel
X 550 Y 140 Z 232

02543

chrome/chrom
X 550 Y 140 Z 232



00042

chrome/chrom
X 625 Y 180 Z 275



aluminium

00081

chrome/chrom
90x90x90cm, Ø 20mm



aluminium

72502

white/biały
90x90x90cm, Ø 20mm



00080

stainless steel/stal nierdzewna
chrome/chrom
70x120cm, Ø 22mm

00037

stainless steel/stal nierdzewna
chrome/chrom
125x220cm, Ø 22mm



72202

aluminium
white/biały
70x120cm, Ø 22mm

72402

aluminium
white/biały
125x220cm, Ø 22mm



set of 12pcs/kpl.12szt.

91202

plastic/plastik
white/biały

97200

plastic/plastik
transparent/przezroczysty



08702 TXT

white/biały
180x200 cm



03502 PEVA

white/biały
180x200 cm

SUPPLEMENTARY ACCESSORIES

AKCESORIA UZUPEŁNIAJĄCE

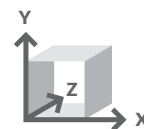

STAINLESS STEEL / STAL NIERDZEWNA

MASTERLINE
by Bisk



71275

chrome/chrom

04790

white/biały

71276

brushed/szczotkowana
X 265 Y 55 Z 70
Ø 19 mm



71850

chrome/chrom

04811

white/biały

71851

brushed/szczotkowana
X 335 Y 55 Z 80
Ø 22 mm



04791

white/biały

71875

chrome/chrom

71876

brushed/szczotkowana
X 80 Y 240 Z 380
Ø 25 mm



71925

chrome/chrom

71926

brushed/szczotkowana
X 115 Y 200 Z 440
Ø 25 mm



01419

brushed/szczotkowana
X 140 Y 90 Z 105



01418

chrome/chrom
X 140 Y 90 Z 105



00102

chrome/chrom
X 640 Y 55 Z 80
Ø 25 mm

04812

white/biały
X 640 Y 55 Z 80
Ø 25 mm

MASTERLINE
by Bisk



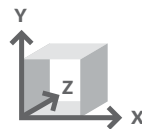

gwarancja **LAT 5** years Guarantee

Safe home



Bezpieczny dom



stainless steel/stal nierdzewna
Ø 25 mm

max 150 kg
test 225 kg

technical drawings – p. 25
rysunki techniczne – str. 25

stainless steel/stal nierdzewna
Ø 25 mm

max 120 kg
test 180 kg

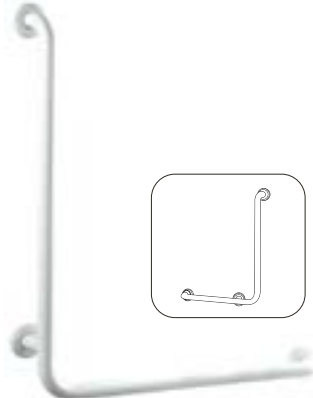
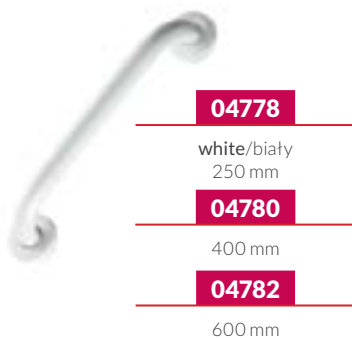
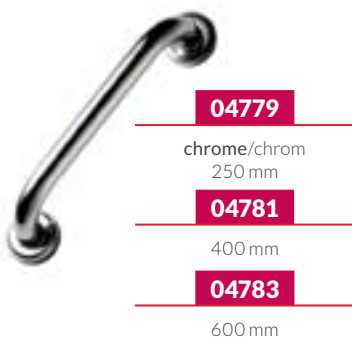

stainless steel/stal nierdzewna
Ø 25 mm

max 120 kg
test 180 kg



installation
montaż



Atest PZH

Carry the CE mark, have hygienic approval from the National Institute of Hygiene of the Polish Institute of Public Health, are registered with The Office for Registration of Medicinal Products, Medical Devices and Biocidal Products as Class I medical devices.

Wyroby zarejestrowane w Urzędzie Rejestracji Produktów Leczniczych, Wyrobów Medycznych i Produktów Biobójczych jako Wyrób Medyczny Klasy I.

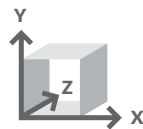

MASTERLINE

by Bisk



Safety
Regular
Production
Surveillance

LAT
5
YEARS
Guarantee

max 120 kg
test 180 kg



06218

AI/PE
X 720-820 Y 180 Z 280

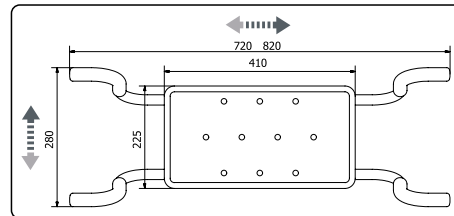

Atest PZH

Carry the CE mark, have hygienic approval from the National Institute of Hygiene of the Polish Institute of Public Health, are registered with The Office for Registration of Medicinal Products, Medical Devices and Biocidal Products as Class I medical devices.

Wyroby zarejestrowane w Urzędzie Rejestracji Produktów Leczniczych, Wyrobów Medycznych i Produktów Biobójczych jako Wyrób Medyczny Klasy I.



Safety
Regular
Production
Surveillance

LAT
5
YEARS
Guarantee

max 150 kg
test 225 kg



max 526 mm

min 348 mm

04813

AI/PE
X 440 Y 348-526 Z 440

Atest PZH



Safety
Regular
Production
Surveillance

www.tuv.com
ID: 0000045827



680 mm

04956

stainless steel/stal nierdzewna
chrome/chrom
X 103 Y 680 Z 103

max 130 kg



04965

X 255 Y 50 Z 260

HANDICAP ACCESSORIES

AKCESORIA DLA NIEPEŁNOSPRAWNYCH

MASTERLINE
by Bisk

Article available on request / Towar dostępny na zamówienie



stainless steel/stal nierdzewna

00163

chrome/chrom
60 cm, Ø30 mm



painted steel/stal malowana

01398

white/biały
60 cm, Ø25 mm



stainless steel/stal nierdzewna

00167

chrome/chrom, Ø30 mm
75 x 80 cm, right/prawy

01384

chrome/chrom, Ø30 mm
75 x 80 cm, left/lewy



painted steel/stal malowana

01400

white/biały, Ø25 mm
75 x 60 cm, right/prawy

01524

white/biały, Ø25 mm
75 x 60 cm, left/lewy



stainless steel/stal nierdzewna

00165

chrome/chrom, Ø30 mm
55 cm, right/prawy

00166

chrome/chrom, Ø30 mm
55 cm, left/lewy



stainless steel/stal nierdzewna

01385

chrome/chrom
60 x 60 cm



painted steel/stal malowana

01390

white/biały, Ø25 mm
50 cm, right/prawy

01391

white/biały, Ø25 mm
50 cm, left/lewy



stainless steel/stal nierdzewna

01386

45 x 40 cm
chrome/chrom, Ø25 mm

painted steel/stal malowana

01527

45 x 40 cm
white/biały, Ø25 mm

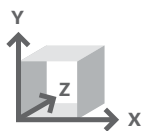

SELECTED COLLECTIONS WYBRANE KOLEKCJE

MASTERLINE
by Bisk

CHROME & HPL / CHROM & HPL

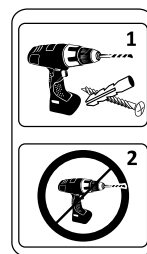

BERGEN



07101

X 100 Y 154 Z 130



07053

X 150 Y 40 Z 115



07602

X 25 Y 70 Z 25



07063

X 25 Y 50 Z 90



07104

X 230 Y 120 Z 115



07064

X 100 Y 120 Z 115



07065

X 180 Y 120 Z 115



07103

X 190 Y 190 Z 60



07069 (310)

X 310 Y 40 Z 115



07061

X 180 Y 40 Z 115



07056 (450)

X 450 Y 40 Z 125



07059

X 130 Y 360 Z 145



07066 (600)

X 600 Y 40 Z 115

BISK CATALOGUE KATALOG BISK







reddot design award
winner 2012

5 YEARS
LAT
guarantee

SELECTED COLLECTIONS WYBRANE KOLEKCJE

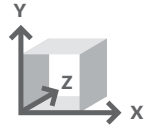

MASTERLINE *by Bisk*

BLACK SATIN / CZARNA SATYNA

FUTURA



02953

X 70 Y 140 Z 100



02962

X 30 Y 160 Z 70



02959

X 65 Y 93 Z 90



02963

X 132 Y 95 Z 30



02969

X 200 Y 175 Z 30



02961

X 135 Y 120 Z 30



02954

X 130 Y 40 Z 100



02960

X 130 Y 93 Z 95



02957

X 535 Y 30 Z 110



02965

X 25 Y 57 Z 40



02952

X 175 Y 40 Z 60



02968

X 30 Y 75 Z 435



02956

X 246 Y 30 Z 246



02966 (460)

X 490 Y 30 Z 70



02967 (610)

X 642 Y 30 Z 125



02958

X 90 Y 395 Z 115



SELECTED COLLECTIONS

WYBRANE KOLEKCJE

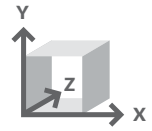

MASTERLINE
by Bisk

CHROME / CHROM

FOR YOU



01177

X 125 Y 175 Z 90



02943

X 100 Y 60 Z 65



01176

X 155 Y 45 Z 90



01173

X 70 Y 45 Z 50



02924

X 110 Y 70 Z 130



03038

X 155 Y 100 Z 65



01174

X 125 Y 95 Z 85



01175

X 190 Y 95 Z 85



04751

X 45 Y 64 Z 470



01180

X 640 Y 45 Z 65



01178

X 160 Y 165 Z 65



01181

X 640 Y 45 Z 115



01183

X 525 Y 45 Z 155



01179

X 160 Y 125 Z 65



01182

X 165 Y 375 Z 125

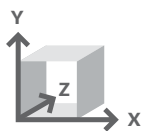

SELECTED COLLECTIONS

WYBRANE KOLEKCJE

MASTERLINE
by Bisk

DEDICATED FAUCET COLLECTION
DEDYKOWANA KOLEKCJA ARMATURY

CHROME/CHROM

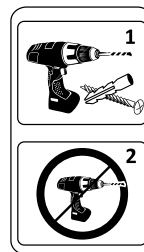

ARKTIC

01465

X 68 Y 95 Z 120

01464

X 200 Y 50 Z 30

5 YEARS GUARANTEE
LAT GWARANCJI

02228

solid brass/mosiądz
single lever bidet mixer
bateria bidetowa
X 55 Y 125 Z 140

5 YEARS GUARANTEE
LAT GWARANCJI

00269

solid brass/mosiądz
single lever, high neck, basin mixer
bateria umywalkowa wysoka
X 55 Y 295 Z 170

01467

X 135 Y 70 Z 130

01476

X 65 Y 155 Z 120

5 YEARS GUARANTEE
LAT GWARANCJI

00267

solid brass/mosiądz
single lever basin mixer
bateria umywalkowa niska
X 55 Y 170 Z 180

01461

X 500 Y 50 Z 128

5 YEARS GUARANTEE
LAT GWARANCJI

00270

solid brass/mosiądz
single lever shower mixer
bateria wannowa
X 190 Y 130 Z 160

01469

X 480 Y 50 Z 75

01463

X 85 Y 50 Z 50

00131

BISK FEST glue
klej BISK FEST

5 YEARS GUARANTEE
LAT GWARANCJI

00271

solid brass/mosiądz
single lever bath mixer
bateria prysznicowa
X 162 Y 100 Z 108

01473

X 130 Y 145 Z 40

01475

X 115 Y 385 Z 150

01474

X 240 Y 50 Z 75

00699

shower set/zestaw natryskowy
BISK FEST glue/klej BISK FEST
easy to fix/łatwy montaż
X 55 Y 600 Z 110

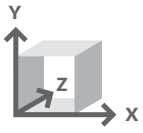

SELECTED COLLECTIONS WYBRANE KOLEKCJE

MASTERLINE *by Bisk*

DEDICATED FAUCET COLLECTION
DEDYKOWANA KOLEKCJA ARMATURY

BRUSHED NICKEL / SZCZOTKOWANY NIKIEL



* installation with screws
montaż przy pomocy śrub



72080

X 66 Y 90 Z 110



72077

X 70 Y 60 Z 50

5 YEARS GUARANTEE
LAT GWARANCJI



02229

solid brass/mosiądz
single lever bidet mixer
bateria bidetowa
X 57 Y 140 Z 135



72082

X 135 Y 60 Z 125



72089

X 65 Y 155 Z 115

5 YEARS GUARANTEE
LAT GWARANCJI



00278

solid brass/mosiądz
single lever basin mixer
bateria umywalkowa niska
X 57 Y 150 Z 165



72142*

X 210 Y 50 Z 30



72079

X 140 Y 130 Z 60

5 YEARS GUARANTEE
LAT GWARANCJI



00285

solid brass/mosiądz
single lever, high neck, basin mixer
bateria umywalkowa wysoka
X 57 Y 305 Z 165



72076

X 605 Y 60 Z 155

5 YEARS GUARANTEE
LAT GWARANCJI



00300

solid brass/mosiądz
single lever bath mixer
bateria wannowa
X 255 Y 60 Z 205



72087

X 620 Y 60 Z 160

5 YEARS GUARANTEE
LAT GWARANCJI



00305

solid brass/mosiądz
single lever shower mixer
bateria prysznicowa
X 255 Y 60 Z 145



72092

X 60 Y 165 Z 70



72088

X 115 Y 375 Z 155



00181

shower set/zestaw natryskowy
BISK FEST glue/klej BISK FEST
easy to fix/łatwy montaż
X 140 Y 600 Z 120

SELECTED COLLECTIONS WYBRANE KOLEKCJE

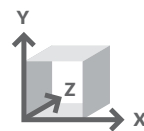

MASTERLINE
by Bisk

POLYSTERENE / POLISTYREN

OCEANIC



46842

X 40 Y 60 Z 45



41142

X 325 Y 70 Z 70



40842

X 120 Y 35 Z 35



47242

X 185 Y 95 Z 105



40742

X 120 Y 95 Z 120



40442

X 160 Y 130 Z 70



41042

X 580 Y 50 Z 140



47142

X 235 Y 90 Z 75



40542

X 160 Y 40 Z 110



40242

X 585 Y 60 Z 140



47042

X 585 Y 85 Z 90



51302

X 440 Y 440 Z 40

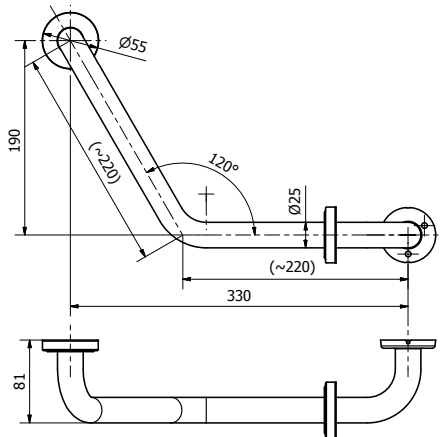

04777

04776

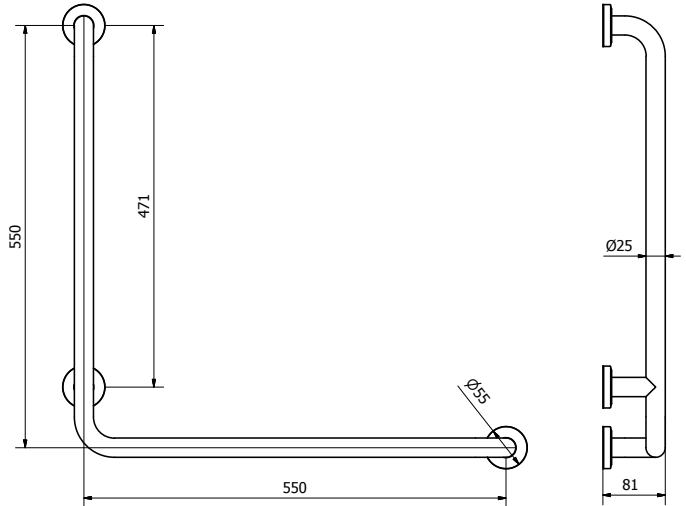

04785

04784

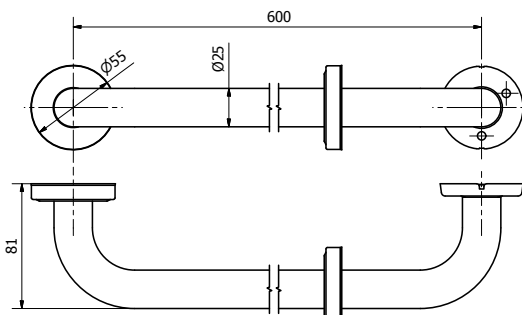

04783

04782

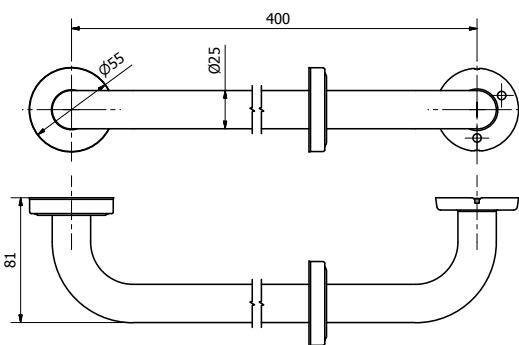

04781

04780

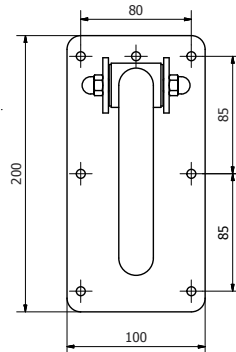

04787

04786

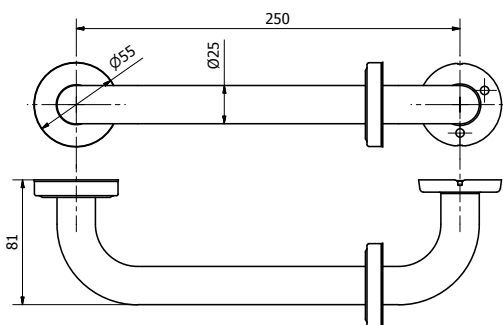
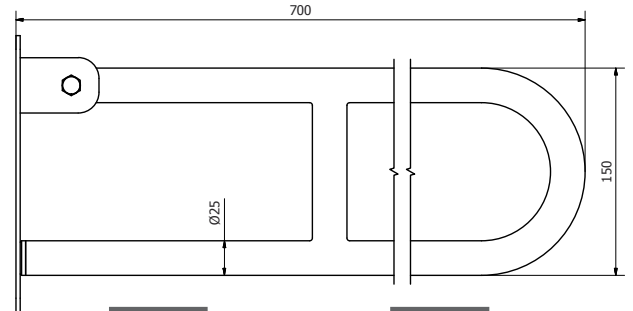

04779

04778

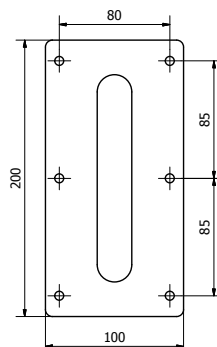

05498

05499

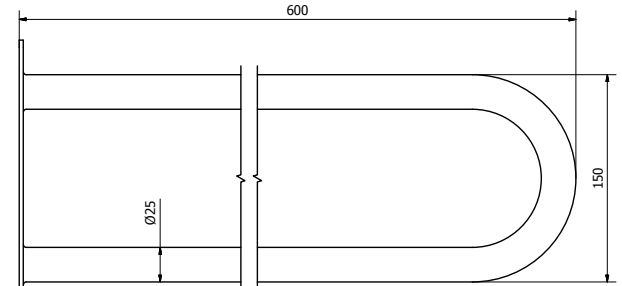



Safe home



Bezpieczny dom





BISK S.A. | ul. Podleśna 19, Łubna, 05-532 Baniocha, Poland
tel. +48 22 736 46 01, fax +48 22 750 36 20, e-mail: bisk@bisk.eu, www.bisk.eu