

New Viega products 2015

Fulfilling the highest demands with the best products.



New Viega products 2015

ALL NEW PRODUCTS AT A GLANCE.



DRINKING WATER HYGIENE

4

AquaVip

6

Hygiene-Assistant with Viega Hygiene+ monitoring function



PIPING SYSTEMS

8

Viega Raxinox

10

Viega Megapress

12

Viega Megapress press-in connection

13

Viega Pressgun Picco

13

Viega press jaws Picco with one-hand snap action function

14

Viega Fonterra Smart Control



DRAINAGE TECHNOLOGY

16

Viega Advantix Vario wall drain

18

Viega Multiplex Trio

19

Viega Multiplex and Multiplex Trio with water level riser



PRE-WALL TECHNOLOGY

20

Viega concealed connection box for washbasins

21

Height-adjustable Viega Eco Plus washbasin element

22

Viega Eco Plus shower-WC element

23

Viega Visign for Style 10



AquaVip

Drinking water is a basic commodity of enormously high importance. It is not without reason that it is by far the most strictly controlled food product. At the same time, it is taken for granted by most people, as it is available without limitation or cost and requires no further consideration in everyday life. The sustainable handling of this important provision for life is one of the top priorities of the German sanitary industry. To ensure that this is also achieved in the future, technicians and planners have to be able to guarantee the preservation of drinking water hygiene reliably at all times. For Viega, the subject is more than just one of many – it becomes a core competence, which extends beyond the development of products, the use of the right materials and the support of the “Blue Responsibility – Sustainable Sanitary Solutions” campaign. With Viega AquaVip, this is expressed once again.

For many years, Viega has been supporting technicians and planners in preserving drinking water hygiene with their innovative product solutions, extensive service and relevant seminars and symposiums. The primary aim is to share knowledge and use it in the right places. This includes, e.g., the products with Viega Hygiene+ function, which help to avoid stagnation and critical temperature values in drinking water installations – either through active flush cycles or by optimising the pipework –, but also extensive and up-to-date seminars on the latest Drinking Water Ordinance. The whole thing is rounded off with extensive consultation by our field staff or directly via the hotline. A particularly broad and incomparable range, which has now been summarised and consolidated under one name by Viega: AquaVip. The new drinking water competence brand helps to keep track of the multitude of laws, standards and regulations for drinking water hygiene, making everyday work easier for technicians, planners, architects and operators.



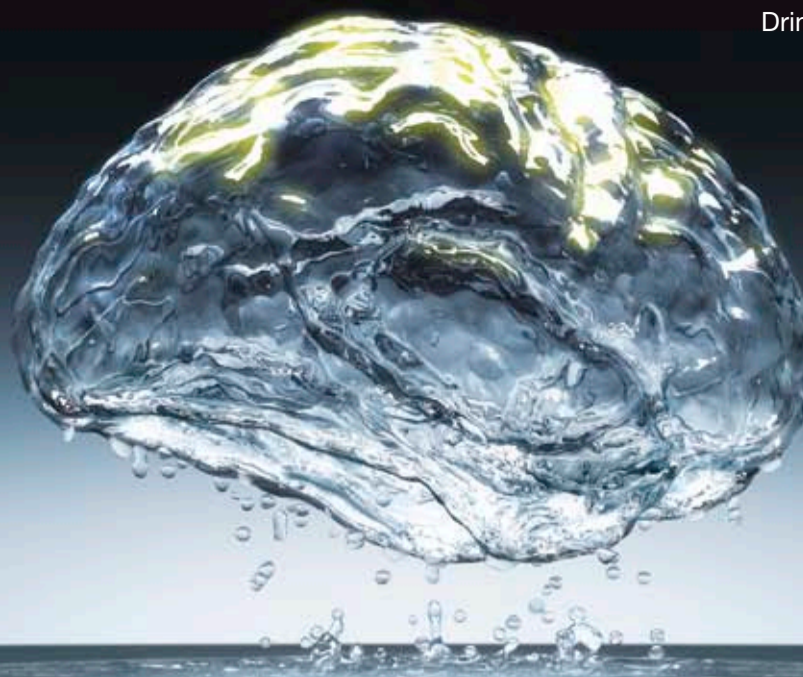

VIEGA INTELLIGENT PROTECTION

What does AquaVip mean?

“Aqua”, that means water. And “Vip” stands for “Viega Intelligent Protection”. From the combination of these two words comes a term that Viega will use in the future to represent everything to do with the preservation of drinking water hygiene.

What does it mean for you?

In principle, nothing is changing for you. AquaVip is not a new product or range. It is more of an umbrella term for all products, seminars and services dealing with the subject of drinking water. So for you, it is a focus point, which concentrates all information and appeals to everyone – whether you’re a planner, technician, architect or operator. In the future, when you see a reference to AquaVip from Viega, you can be sure that the preservation of drinking water hygiene is behind it.

” DRINKING WATER HYGIENE HAS A NEW NAME: AquaVip. “

Systems and products

- economic and innovative system solutions
- press systems suitable for drinking water made from high-quality materials such as stainless steel, copper, gunmetal and plastic
- flow-optimised piping systems
- products with Viega Hygiene+ function

Knowledge transfer

- seminars
- symposiums
- viegajournal
- application specific technical documents
- Viega website

Service and consultation

- field staff
- hotline
- Viptool software packages
- information brochures





HYGIENE-ASSISTANT WITH VIEGA HYGIENE+ MONITORING FUNCTION

It has never been so easy to keep an eye on the proper operation of drinking water installations as it is now with the Hygiene-Assistant with Viega Hygiene+ monitoring function. Multi-functional sensors measure the use and temperature of individual drinking water piping sections and the assistant's display shows the results in comprehensible symbols. Simple read-outs allow conclusions to be drawn on the drinking water quality of the relevant piping section and provides the operator with a recommendation where necessary: carry out water exchange process or no measures required. Critical piping sections are quickly recognised and localised with the Hygiene-Assistant. Any remedial actions and samples can be implemented in a focussed and economic way. With all its strengths, the Hygiene-Assistant is predestined for use in properties with unknown user behaviour.

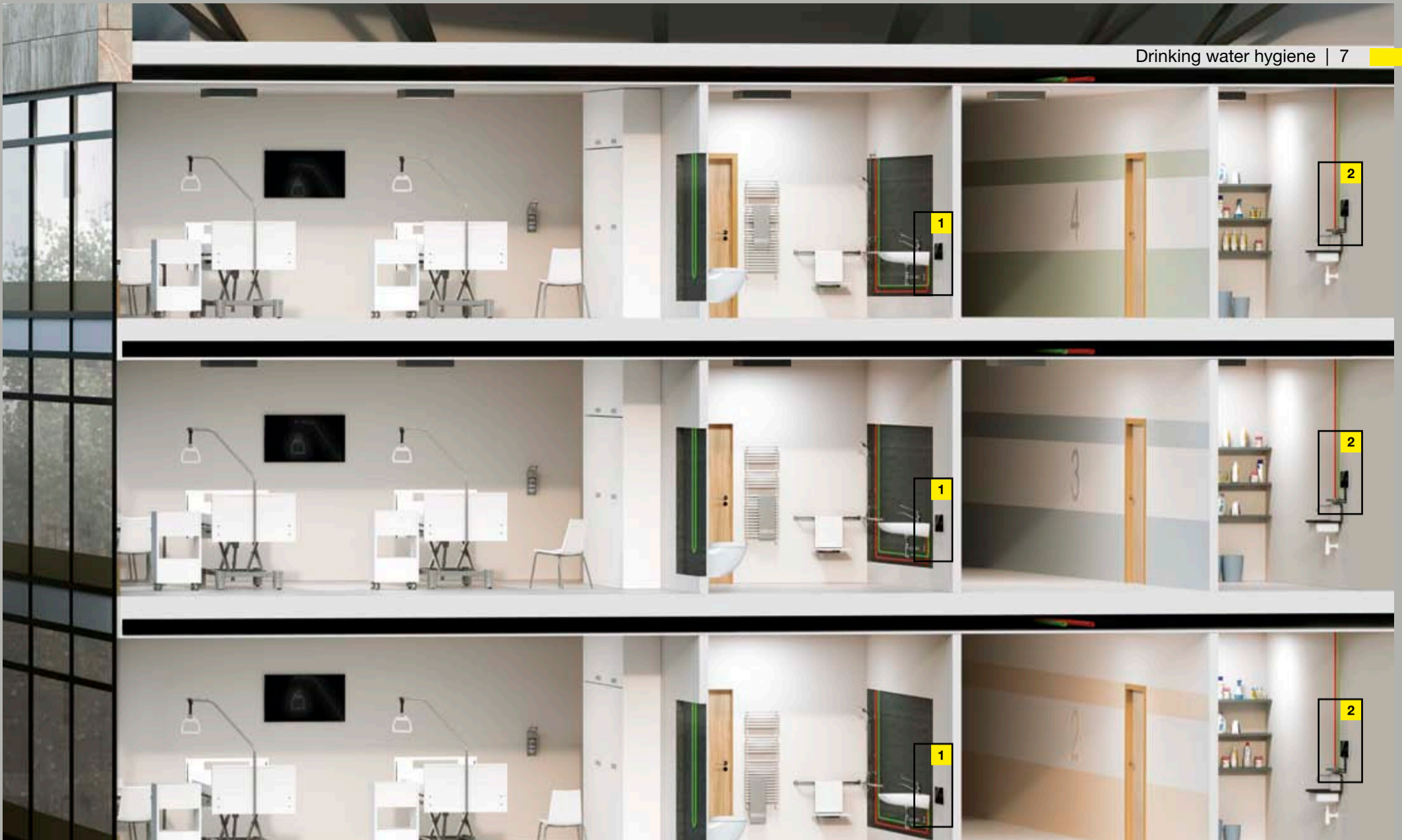

The Hygiene-Assistant is predestined for use in buildings, in which the drinking water installation is used mainly by third parties, e.g. guests or patients, meaning compliance of operations cannot be assumed – such as in hotels, care homes, schools, barracks and hospitals.

The technology

- assistant for simple monitoring and visualisation of use and temperature of individual piping sections of the drinking water installation
- display with understandable symbols, measured states are highlighted using the traffic light principle
- special multi-functional sensors – concealed (fig. 1) or flush mounted (fig. 2) – measure the parameters of individual cold and hot water piping sections that are relevant for the drinking water hygiene
- connection to building automation systems through integrated, potential-free contact is possible, choice of notification when usage exceeds 3 or 7 days
- operation through mains adapter or battery
- available in black and white

The advantages

- automatic logging of measured values of the hygiene-relevant parameters and display at a glance
- intuitively understandable due to simple symbols and traffic light principle
- quick identification of problematic piping sections and focussing of the sample extraction
- reduction of the operating costs through demand-controlled water exchange

” ALWAYS KEEPING AN EYE ON DRINKING WATER HYGIENE. “



Multi functional sensor for concealed installation.



The display of the Hygiene-Assistant is available in black and white.

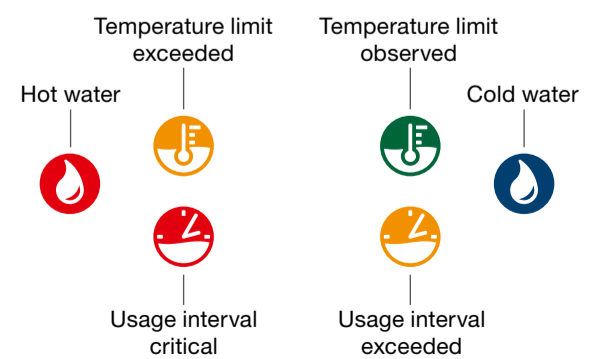

Temperature and usage display for cold and hot water pipes are structured using the traffic light principle (green, orange, red).

VIEGA RAXINOX

In the shape of Raxinox, Viega is launching the first drinking water pipe for stainless steel installation that can be bent by hand. The innovative pipe is equipped with a pressure-resistant and temperature-resistant stainless steel inliner and, together with stainless steel connectors that are radially pressed, forms an economic alternative for drinking water installations on a storey of a building – with great flexibility and the highest hygiene standards. Flow-optimised series and circular pipes can be installed quickly and effortlessly with Viega Raxinox.

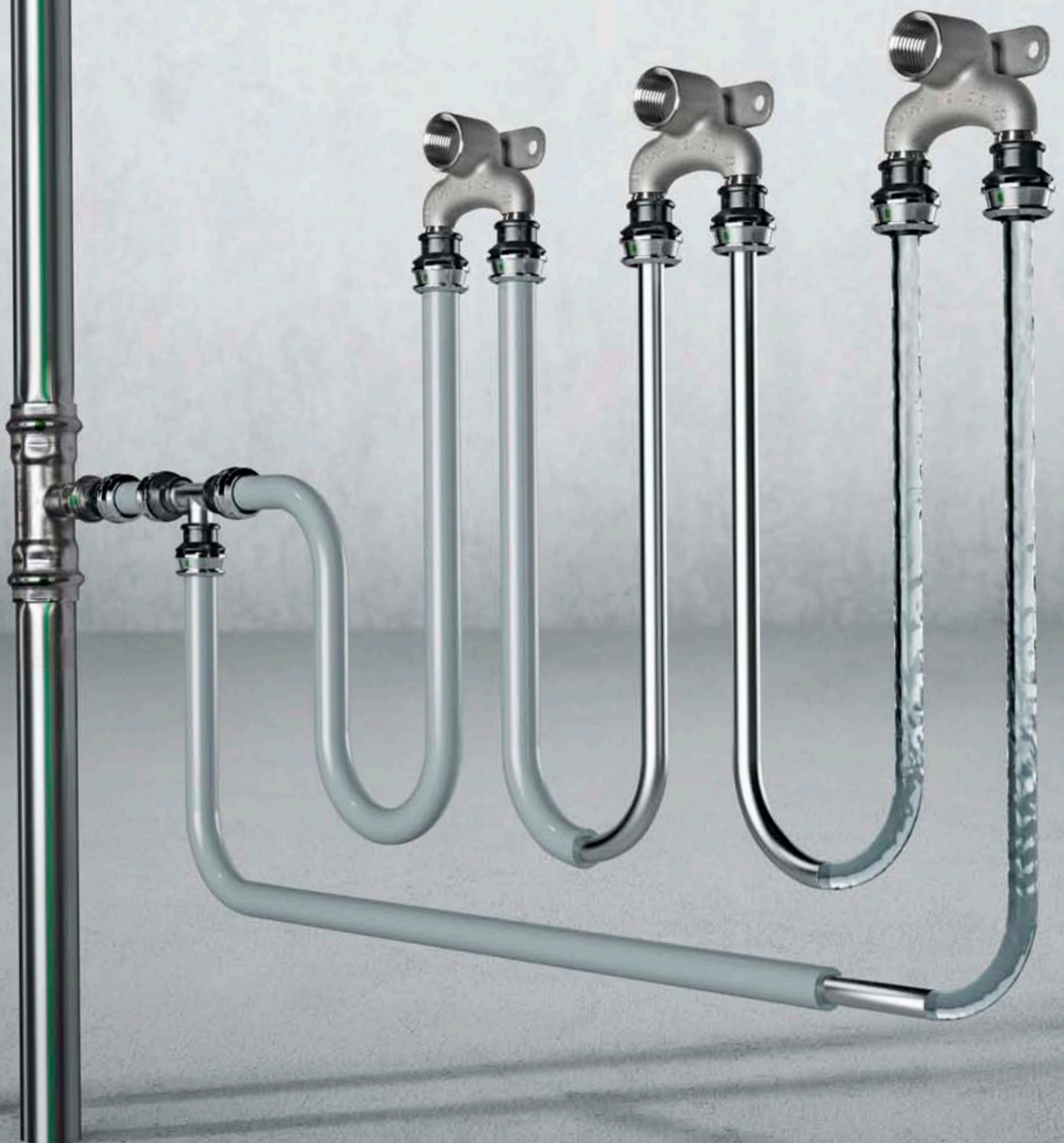

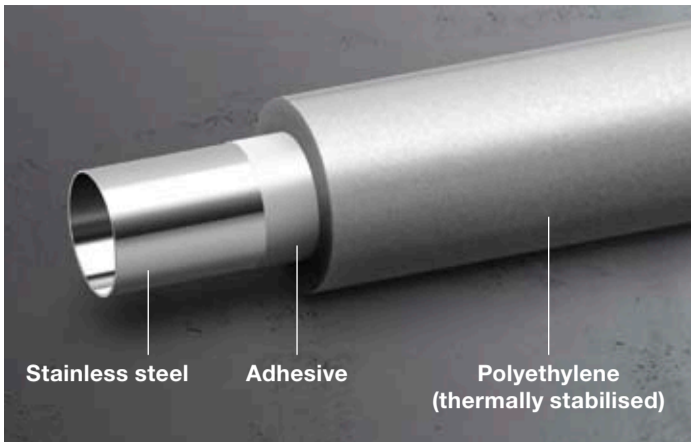

Stainless steel Adhesive Polyethylene (thermally stabilised)

The ultra-stable stainless steel Inliner is encased in a flexible external coating.



The Raxinox pipe is available blank, in a corrugated pipe and in 9 mm or 13 mm insulation.



The Viega SC-Contur immediately highlights any inadvertently unpressed connections.

The technology

- highly stable stainless steel inliner
- standard conformant pre-insulated pipes
- stainless steel connector with minimal cross section constrictions
- tried-and-tested radial press technology without sealing element
- pressing with the existing press tools for radial press technology

The advantages

- all surfaces that come into contact with the media throughout the pipe are made of stainless steel
- can be laid quickly and easily straight from the roll
- saves a lot of connectors as the pipe can be bent by hand
- cost-effective up to the last tapping point
- insertion depth is checked through the inspection window on the connector
- can be easily cut using the Raxinox shears – makes pipe cutter superfluous
- simple transport and comfortable handling
- Viega SC-Contur in all Raxinox connectors

” MAKES STAINLESS STEEL BENDABLE BY HAND. “



1 Cut pipe to length using the Raxinox pipe shears.



2 Round off the cut edge.



3 Position the connector. Check insertion depth in the inspection window.



4 Press – finished!



Moulded parts such as elbows and T-pieces have flow-optimised internal radiuses due to an innovative moulding procedure.



Viega Raxinox double wall panels for easy installation of series and circular pipes.



The tried-and-tested radial pressing guarantees a homogeneous and secure connection.



VIEGA MEGAPRESS

With Megapress, Viega presents the first press system for thick-walled steel pipes. Whether seamless, welded, galvanised, industrially varnished, epoxy resin-coated or black; whether in boiler pipe or threaded pipe quality: Viega Megapress connects pipes with various surfaces in six dimensions from ½" to 2" – within seconds, safely and above all cold. As a result, the laborious welding of steel pipes is a thing of the past. Press technology is up to 60% quicker!



Quick, simple and safe assembly without any welding.



Viega Megapress for heating, cooling and industrial systems.



Like all Viega press systems, Megapress also has the tried-and-tested Viega SC-Contur that immediately highlights any inadvertently unpressed connections.

The technology

- first press technology for thick-walled steel pipes in heating, cooling and industrial systems
- pipe-moulded press connectors made from 1.0308 steel with zinc-nickel coating
- for pipe dimensions of 1/2", 3/4", 1", 1 1/4", 1 1/2" and 2"
- simple pressing of all six Megapress dimensions with the Viega Pressgun 5 and its preceding models
- NEW: Megapress press jaws and press rings with hinted press jaws for the Pressgun Picco to press dimensions of 1/2" and 3/4"

The advantages

- time saving of up to 60 % in comparison with welded connections
- one connector for many different types of pipe
- lasting connections made in seconds
- no welding, no fire watch, no cooling process
- less physical exertion as no unwieldy welding equipment is needed
- perfect for renovations and maintenance
- Viega SC-Contour in all Megapress connectors

” SAVES ASSEMBLY TIME, LABOUR COSTS AND LOTS OF WELDING. “



1

Cut steel pipe to length and clean, mark insertion depth and fit connector up to the marking on the pipe.



2

Position the press jaws or press ring with hinted press jaws around the connector.



3

Press – finished!



With the new Megapress press jaws and rings with hinged press jaws, the Pressgun Picco can now press thick-walled steel pipes – in dimensions of 1/2" and 3/4".



VIEGA MEGAPRESS PRESS-IN CONNECTION

With the Megapress press-in connection, Viega offers a real solution for the retrospective positioning of connections in an existing steel pipe installation. The pipe is simply drilled with the relevant tool set and then the threaded connection is pressed using a Viega press tool. E. g., a thermometer can be quickly fitted into an existing steel pipe installation without any laborious preliminary works. The installation can be used again immediately.

The technology

- a conventional drill, a Viega press tool and the adequate tool set are needed for the installation
- the tool set contains a holding device, drill shaft and press tool insert in the practical case
- the press-in connection is suitable for steel pipes in accordance with DIN EN 10220/10255 and is available for steel pipe dimensions of 1 1/2", 2, 2 1/2", 3", 4", 5" and 6"
- equipped with an 3/4" internal thread; a reducer for a 1/2" internal thread is also available
- made from robust steel with zinc-nickel coating, reducer made of gunmetal

The advantages

- up to 80 % quicker than welding a connection
- no welding, no fire watch, no smoke emissions
- 100 % leak-proof with integrated profile sealing element
- any residual water that flows into the pipe is no problem with press technology
- no cutting of the entire pipe, just drilling
- direct suction of any chippings by attaching an industrial vacuum cleaner to the holding device
- reduction of operational downtimes and costs to a minimum
- space saving due to small dimensions
- simple work, even in hard-to-access places
- unpressed connections are visible with the Viega SC-Contur



1
Tighten the holding device firmly around the steel pipe to guide the drill shaft.



2
Drill using the drill shaft and a conventional drill, then remove the holding device.



3
Press the press-in connection into the pipe with the press machine and press insert.



INSERT UP TO 80% FASTER IN
ANY STEEL PIPE INSTALLATION.





VIEGA PRESSGUN PICCO

The improved Viega Pressgun Picco shows that technical greatness can be tucked into even the smallest dimensions. The ergonomic shape makes the 2.5 kg lightweight (without press jaws) the number one choice for pressing small pipe dimensions.

The technology

- design adapted to Pressgun 5
- LED lamp
- TÜV-approved safety technology
- for metallic piping systems in the dimensions 12 to 35 mm, for plastic piping systems from 12 to 40 mm
- NEW: for Megapress steel pipe connectors from 1/2" to 3/4"

The advantages

- integrated illumination of the press points
- optional use of battery or mains adaptor
- long maintenance lithium ion battery with 18 V/2.0 Ah

” EVEN MORE COMFORT
PACKED COMPACTLY. “

VIEGA PRESS JAWS PICCO WITH ONE-HAND SNAP ACTION FUNCTION

The Picco press jaws with one-hand snap action function are available for all metallic Viega pipe systems (except Megapress) and allow real one-hand operation throughout the entire press procedure. This increases the work and design security once again.



Once opened, the press jaws are kept open by a spring.



This means that you have a hand free to align or fix the installation when applying the press jaws.



The press jaws close automatically when the start switch is pressed once. The press procedure is carried out when the switch is pressed again.



Actuator modules are inserted at the temperature measuring points and connected with one another and the base unit using a broadband cable.



The intelligent base unit communicates with room thermostats and actuator modules.



The highly sensitive room thermostat reacts to the slightest deviations in temperature (available in black and white).

DESIGN PLUS
powered by: **ISH**

The technology

- intelligent regulation for all surface heating and cooling systems
- dynamic, hydraulic compensation, through continual evaluation of supply, room and return temperature for each heating circuit
- ultra-sensitive room thermostats observe the slightest temperature differences
- "Plug and Play" principle through pre-assembled plug-in connector
- actuator modules allocate the heating circuits to the relevant rooms
- the analysis of measurements prevents any overshooting of the room temperature when reaching the target temperature
- analysis of the necessary supply temperature to optimise the heating curve
- preservation of floor temperature even with external heat influence
- operation with smartphone, tablet, laptop or using building control system
- can be retrofitted at any time for all heating circuit distributors with valve insert M30 x 1.5 and Eurocone connection

The advantages

- planning and operational safety through dynamic, hydraulic compensation: irrespective of installation distances, heating circuit lengths, screed heights, floor coverings, external temperatures or external heat influences
- considerable time saving when assembling and commissioning due to "Plug and Play" principle and automatic hydraulic compensation
- maximum comfort through preservation of floor temperature, even with external heat influence
- short reaction times due to no complete deactivation
- up to 20 % energy cost saving through rapid recognition of temperature changes and optimisation recommendation
- simple and intuitive operation by technicians and end consumers in WLAN network through browser-based user interface
- rapid heating possible thanks to definition of prioritised rooms and determination of user dependant heating profiles
- Set-up of output stages for secondary rooms without room thermostat
- absence mode and anticipated return time can be set

” THIS SYSTEM KNOWS HOW TO CONTROL ITSELF. “

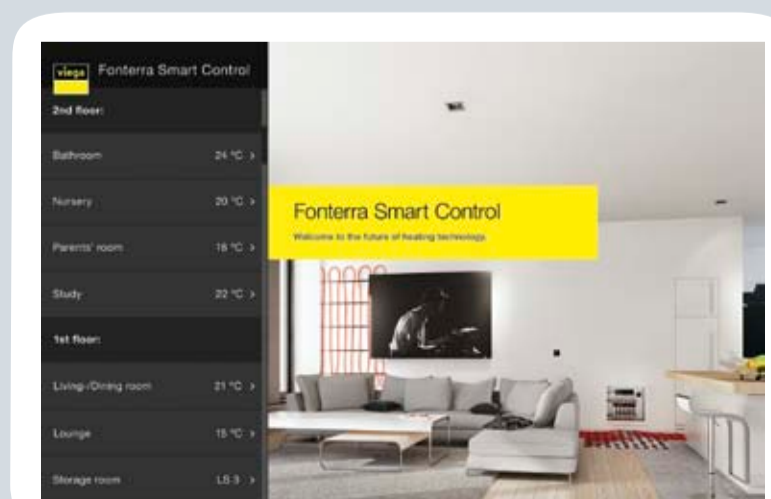
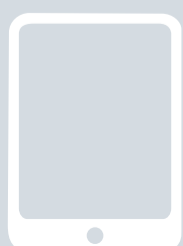

Smart operation:
Simple set-up and operation using browser-based user interface and creation of individual heating profiles with various comfort functions.

VIEGA ADVANTIX VARIO WALL DRAIN

With the new Advantix Vario wall drain, Viega is bringing the flexibility and design of the Advantix Vario shower channel from the floor to the wall. The beauty in it: All visible elements of the wall drain are reduced to the essential: With its puristical design and use of high-quality materials, it will become an integrative part of timeless architecture.



The low installation depth enables installation in a lightweight construction wall...



...as well as in or on a solid wall.

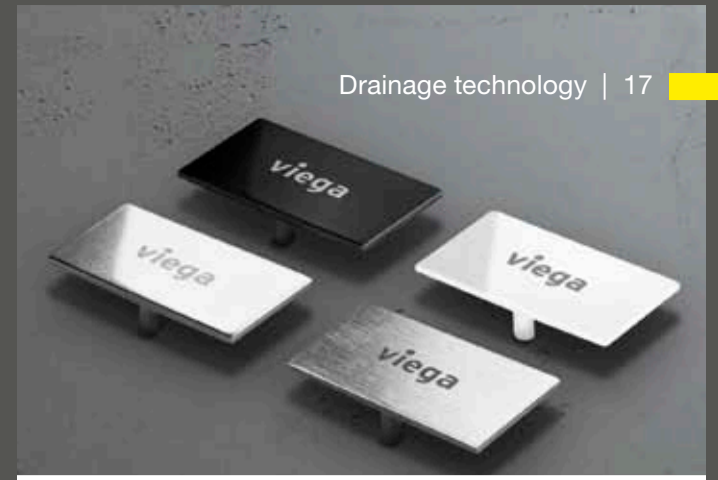

Colour variations: matt stainless steel, gloss stainless steel, black and white.

The technology

- super-flat wall installation depth of just 25 mm
- can be used in and on solid walls as well as in lightweight construction and pre-wall structures
- can be cut to length precisely, from 300 mm to 1,200 mm
- available in two designs, as a standard or sanitary drain with a construction height of just 70 mm
- extremely narrow drainage slot of just 20 mm, can be used with a grate
- with sealant accessories and tiler's set for cross-sector collaboration of fitter and tiler
- for wall and floor coverings of up to 28 mm in thickness without any accessories

The advantages

- versatile uses, even in small sanitary rooms, due to extremely low wall installation depth and variable installation length
- standardised installation of flooring up to wall without any inclines needing to be cut in
- hygienic and easy to clean, due to smooth-walled base plate without dead space
- harmonious in any bathroom design due to reduced design of grate and cover plate in four colours
- particularly elegant, flat water flow over the entire width of the drain

“ ONLY 2.5 CENTIMETRES WALL INSTALLATION DEPTH AND MILLIMETRE-PRECISE INDIVIDUALITY ”



1 Shorten the channel base unit with a hacksaw and the cutting aid, deburr cut surfaces, apply sealing caps and screw tight.



2 Thanks to the height-adjustability of the tiling aid, the drainage slot can be set to exactly 20 mm.



3 After tiling and grouting, the standing grate and cover panel are mounted.



VIEGA MULTIPLEX TRIO

After the optimisation of the Multiplex drain fittings, Viega has now reduced the Multiplex Trio range to one functional unit and combined the best technical properties with award-winning design. With an installation depth of just 33 mm, the Multiplex Trio is also suitable for modern bathtubs with particularly narrow rims.

The technology

- one functional unit fit all three design equipment sets Visign MT 3, MT 5 and MT 9
- only 33 mm installation depth
- the overflow pipe can be bent by up to 40°
- Bowden wires with optimal anti-kink protection
- 8% higher drainage capacity

The advantages

- simple choice of design: one functional unit for all equipment sets
- award-winning design
- extremely flat construction of the equipment sets Visign MT 3 and MT 5
- additional function of water level riser with the equipment set Visign MT 9
- water jet angle can be set to individual slope of the bathtub rim
- due to the low installation depth, suitable for nearly every bathtub type – even those with particularly small rims



From now on the technology behind the designer equipment sets Visign MT 3, MT 5 and MT 9 are uniformed and up-to-date.



THE BEST TECHNOLOGY
FOR ALL DESIGNS.



VIEGA MULTIPLEX AND MULTIPLEX TRIO WITH WATER LEVEL RISER

The new Multiplex drainage and overflow fittings with Visign M 9 and the Multiplex Trio drainage, overflow and inlet fittings with Visign MT 9 are not just impressive with their design. Their innovative overflow increase is also remarkable. With a single movement, the maximum water level in the bathtub can be increased by 50 mm.

The technology

- fits all Multiplex or Multiplex Trio functional units from the 2015 model year
- when the designer rosette is pressed, the lower edge of the overflow closes, water then only flows over the upper edge
- a slight tug on the actuating unit lowers the water level back to the normal level
- in all cases, the secure overflow function is unchanged

The advantages

- raising of the water level by 50 mm
- increased comfort
- appealing design



Reduced, straight-lined and closed design.



Fitting open: The water flows out at the lower edge.



Fitting closed: The water flows out of the upper edge and the water level rises by 50 mm.



LIFTS BOTH THE WATER AND COMFORT LEVEL.



VIEGA CONCEALED CONNECTION BOX FOR WASHBASINS

The Viega concealed connection box not only combines all the connection components for washbasins into a pre-fabricated unit – it also comes with an appealing appearance. The odour trap and corner valves disappear into the wall. What remains are the horizontal drainage bend, an elegant cover panel and lots of free space beneath the washbasin. The concealed connection box is available as a Steptec module, Viega Eco Plus element or as an individual component for wet construction.



1. Plastic casing
2. Chrome-plated drainage elbow
3. Concealed odour trap
4. Connections for hot and cold water

The technology

- all washbasin connections integrated: corner regulating valve for hot and cold water, concealed odour trap, connection to wastewater pipe, cable inlet (e.g. for power connection of contactless fittings)
- integrated line connection possible
- can be used as an individual component in wet construction and pre-fabricated in Steptec or Viega Eco Plus pre-wall constructions
- pre-installed connection for DN 40 and DN 50 wastewater pipes

The advantages

- available for Steptec, Viega Eco Plus and Viega Mono designs
- more free space beneath the washbasin due to space-saving concealed odour trap and concealed connections
- elegant, reduced design
- option to underpin and position the washbasin
- easy cleaning
- chrome-plated drainage elbow and cover panel



ALL CONNECTIONS
COMBINED INTO ONE BOX.





HEIGHT-ADJUSTABLE VIEGA ECO PLUS WASHBASIN ELEMENT

The individually height-adjustable Viega Eco Plus washbasin element can be raised and lowered to the desired user height at the touch of a button. And like the successful, individually height-adjustable WC element from Viega, this is done purely mechanically without any electronics. Together with the integrated concealed connection box, the bathroom gains in both comfort and space.

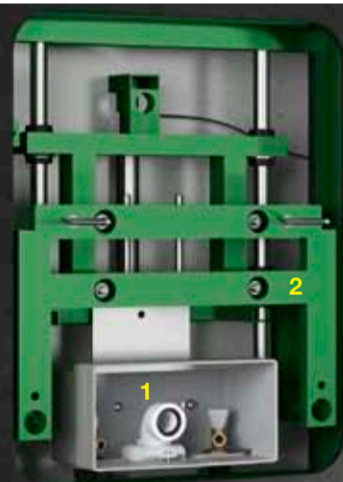

1. Concealed connection box
2. Height-adjustable support surface for washbasin ceramic

The height-adjustable washbasin element contains the complete technology as well as a concealed connection box.

The technology

- actuation of the raising and lowering function at the touch of a button
- secure fixing of the washbasin to the desired height
- suitable for many different washbasin ceramics
- integrated concealed connection box

The advantages

- individual height adjustment of the washbasin
- all the technology is hidden behind a high-quality glass panel
- reliable function carried out by mechanical actuation
- actuating button can always be reached through the glass cover due to selectable position
- comfort in appealing design

” ALWAYS THE RIGHT HEIGHT AT THE TOUCH OF A BUTTON. “

VIEGA ECO PLUS SHOWER-WC ELEMENT

The Viega Eco Plus element not only combines all the necessary connections for shower-WCs and shower-WC attachments into one pre-wall element. It also overcomes the challenge of non-standardised connections. All the technology is hidden behind a light grey glass panel – the perfect answer to the large product diversity on the market.



With Viega Eco Plus shower-WC elements, all the technology is hidden behind a high-quality glass panel.

The technology

- the element can be configured using the enclosed accessories to any connection situation
- prepared water connection for cistern and shower-WC
- connections for water and electricity are accessible behind the glass cover panel

The advantages

- can be used universally – for a wide range of shower-WCs and shower-WC attachments
- shower-WC can also be retrofitted
- all connections are hidden behind the glass panel
- appealing glass cover panel in clear/light-grey



A PRE-WALL ELEMENT
THAT THAT KEEPS
ALL OPTIONS OPEN.





VIEGA VISIGN FOR STYLE 10

The successful Visign for Style 10 actuating panel is being expanded: one new WC and six new colours for urinal actuation. Further four special colours are available on request. This gives you more options to incorporate a consistent design into a modern bathroom design. Naturally, nothing has changed in terms of the tried-and-tested technology.



The technology

- actuating panels made from high-quality plastic
- manual actuation
- can be fitted on tiles or flush to the tiles

The advantages

- individual design leeway in white, black, pergamon, chrome-plated, matt and stainless steel colours
- appealing design with good price-performance ratio



The new urinal actuating panels, e.g. available in alpine white, chrome-plated or black.



The new WC actuating panels in black.

” MORE POSSIBILITIES IN BATHROOM DESIGN. “

VIEGA ACTUATING PANEL CONFIGURATOR

With the Viega actuating panel configurator, you will find the right actuating panel for your bathroom design in just a few clicks and can even view this in your own installation – so you will satisfy even the highest customer demands.

Operation is easy and intuitive. All WC and urinal actuating panels are stored in the configurator. For anyone who is looking for a specific material or flush technology, the actuating panel selection can quickly be restricted using a filter function. Single-colour backgrounds and tiles, which can be adapted in colour and size, are used to help visualise the installation. Even the colour of the joints and the joint width can be individually adapted. If you want it to be even more unique, simply import a photo of the bathroom in question. When the right actuating panel is found, you will get an overview of the created configuration and can also display the materials list for the order immediately – always with a pre-wall element to match your configuration, of course.



Thanks to the intuitive operation, you will find the right actuating panel in just a few clicks.



Scan the QR code and try the configurator now – or access it in your browser at viega.com/flushplates



EX VIEGA PERIENCE

Die Roadshow 2015

Leipzig, Messe
22.04.2015
Munich, Messe
29.04.2015

Nuremberg, Arena
06.05.2015
Salzburg, Arena
12.05.2015

Stuttgart,
H.-M.-Schleyer-Halle
21.05.2015

Hamburg, Messe
03.06.2015
Cologne, Lanxess Arena
10.06.2015

viega.de/Roadshow

Be there and experience it live

The Roadshow is just around the corner and Viega is making its way to you. What is there to see there? There will be any number of new products from ISH, current discussion topics from the sector and sensational show with intoxicating atmosphere that will thrill and delight you. Most certainly an unforgettable evening and experience you should not miss – that is the Viega experience. The best thing to do is to find the most suitable date and location and register for the Roadshow 2015 online. The Viega Experience show will be presented in German.



viega

