

GROHE

WATER TECHNOLOGY

28 690

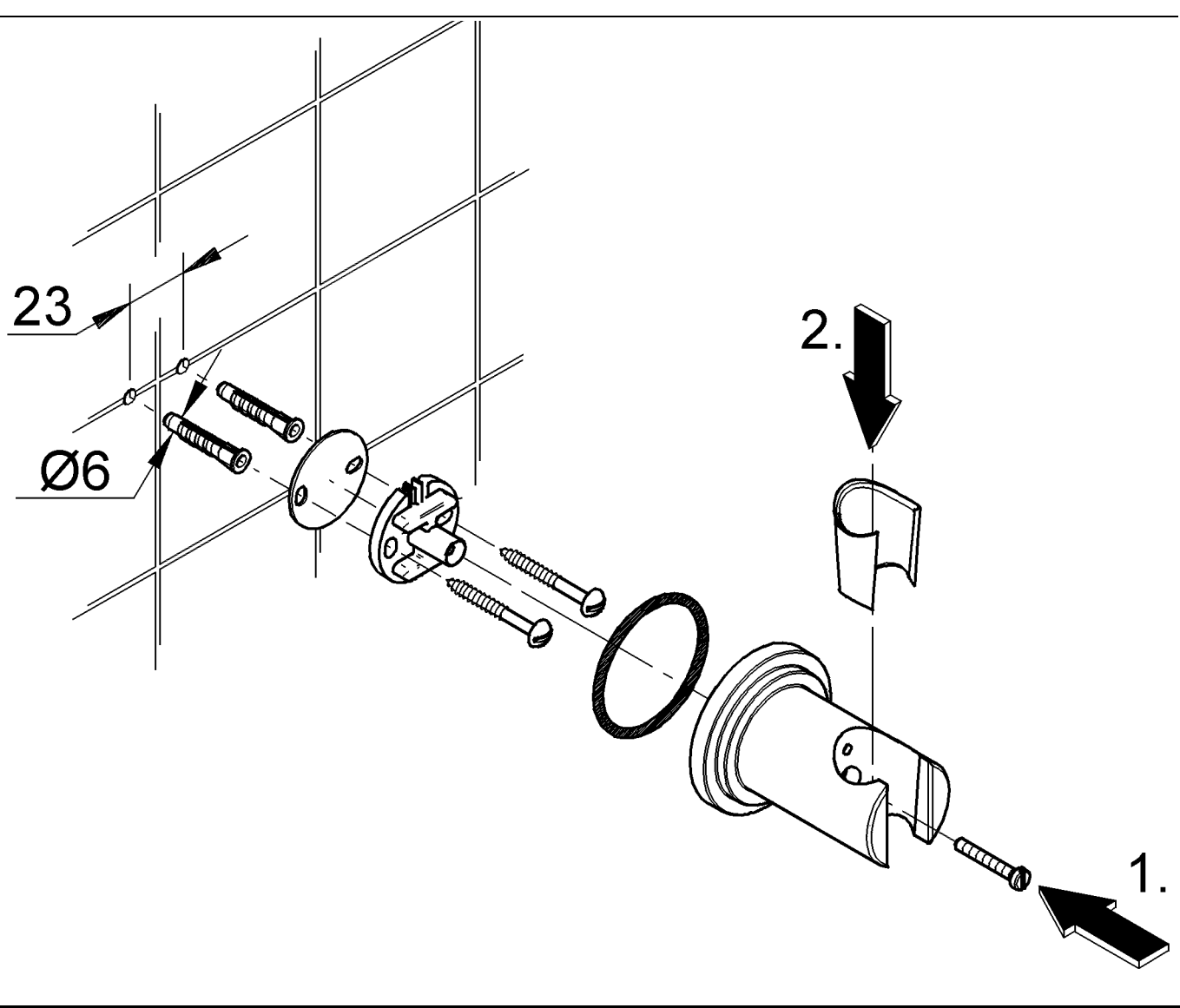
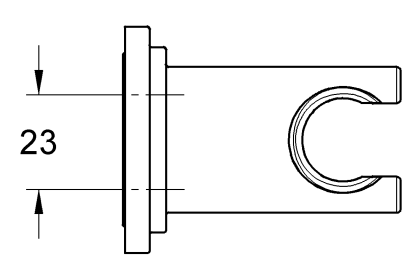
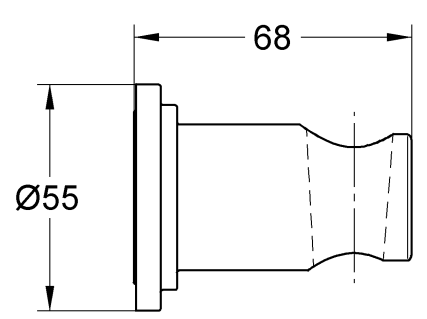

94.017.131/ÄM 39 005/04.02

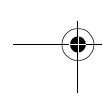
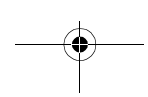
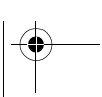
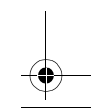
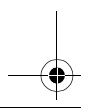
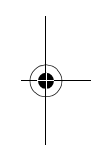
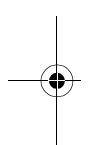

GROHE

WATER TECHNOLOGY

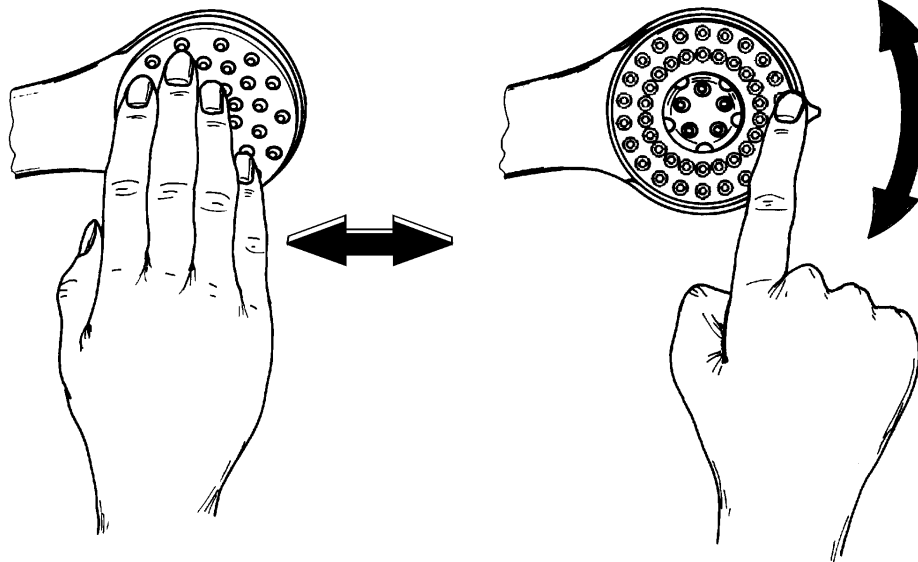

| | | |
|---|--|---|
| <p>D</p> <p>5 Jahre Garantie auf die gleichbleibende Funktion der SpeedClean-Düsen. Kalkablagerungen werden durch einfaches Drüberstreichen entfernt.</p> | <p>GB</p> <p>Guaranteed for 5 years, the "SpeedClean" jets can be freed of limescale simply by wiping across them firmly with the palm of your hand.</p> | <p>F</p> <p>Les dépôts de calcaire s'éliminent par simple passage de la main sur les buses. 5 ans de garantie sur le fonctionnement des buses SpeedClean.</p> |
| <p>E</p> <p>5 años de garantía sobre el correcto funcionamiento de los conos anticalcáreos "SpeedClean". Los sedimentos se eliminan pasando simplemente la mano.</p> | <p>I</p> <p>5 anni di garanzia sul costante funzionamento degli spruzzatori SpeedClean. I depositi di calcare si rimuovono semplicemente passandovi sopra una mano.</p> | <p>NL</p> <p>5 jaar garantie op de gelijkblijvende functie van de SpeedClean-sproeiers. Kalkafzettingen kunnen eenvoudig worden verwijderd door er met hand overheen te wrijven.</p> |

| | | |
|---|---|--|
| <p>S</p> <p>Vi ger års garanti på de SpeedClean-munstyckenas goda funktion. Kalkavlagringar tar du helt enkelt bort med handen.</p> | <p>DK</p> <p>Der ydes 5 års garanti for, at de SpeedClean-dysers funktion forbliver uforandret. Kalkaflejringer stryges af med hånden.</p> | <p>N</p> <p>5 års garanti på en konstant funksjon for de SpeedClean-dysene. Kalkdanneise kan fjernes ved ganske enkelt å tørke av dysene.</p> |
| <p>FIN</p> <p>5 vuoden takuu SpeedClean-suihkun moitteettomalle toiminnalle. Kalkkikerrostumat poistetaan yksinkertaisesti pyyhkäisemällä.</p> | <p>PL</p> <p>5 lat gwarancji na niezawodne działanie dysz typu SpeedClean. Osad wapienny może być usunięty poprzez zwykłe przetarcie powierzchni dysz.</p> | <p>UAE</p> <p>تنزع الترسبات الكلسية بمسحة بسيطة على الرؤوس المطاطية. ضمانة ٥ سنوات على الرؤوس المطاطية SpeedClean.</p> |
| <p>GR</p> <p>5 χρόνια εγγύηση για την απaráλλακτη λειτουργία των μπεκ SpeedClean. Τα στρώματα της ασβέστου απομακρύνονται εύκολα, τρίβοντάς τα το χέρι.</p> | <p>CZ</p> <p>5 let garance na stabilní funkci SpeedClean-trysek. Vápenaté usazeniny odstraní jednoduchým přetřením povrchu.</p> | <p>H</p> <p>5 év garancia a SpeedClean fúvókák változatlan működésére. A vízkőlerakódások egyszerű áttöréssel távolíthatók el.</p> |
| <p>P</p> <p>5 anos de garantia para o funcionamento correcto dos ejetores SpeedClean. Depósitos calcários podem ser removidos passando simplesmente por cima com a mão ou um pano.</p> | <p>TR</p> <p>SpeedClean memelerinin deđişmeden kalan fonksiyonu için 5 yıl garanti. Kireç kalıntılarını hafif silmeyle temizlenebilir.</p> | <p>RUS</p> <p>5 лет гарантии на неизменность функций распыляющих насадок с быстрой очисткой. Отложения извести снимаются простым удалением вручную.</p> |
| <p>SK</p> <p>5 rokov záruka na stabilnú funkciu SpeedClean-trysiek. Vápenaté usadeniny odstránit' jednoduchým pretrením povrchu.</p> | <p>SLO</p> <p>5 let garancije na enakomerno delovanje šobe »SpeedClean«. Obloge kalcija odstranimo s preprostimi potegom roke.</p> | <p>HR</p> <p>5 godina garancije na nepromijenjenu funkciju SpeedClean-sapnica. Talozi vapnenca odstranjuju se tako, da se jednostavno prebriše.</p> |
| <p>BG</p> <p>5 години гаранция за функционирането на дюзите - SpeedClean. Отлагания от варовик се отстраняват лесно чрез избърсване с ръка.</p> | <p>EST</p> <p>SpeedClean-düüside muutumatu töötamise garantiajaks on 5 aastat. Kattakivi saab eemaldada lihtsa ülepühkimise teel.</p> | <p>LV</p> <p>"SpeedClean" sprauslu nemainīgai funkcionēšanai tiek dota 5 gadu garantija. Kalkļa nogulsņņumus var vienkārši noberzt ar roku.</p> |
| <p>LT</p> <p>Speed Clean antgalio garantinis laikas yra 5 m. Susikaupusių apnašų sluoksnis pašalinamas, jį nutrinant.</p> | | |